

**F375A  
FL375A  
F425A  
FL425A**

## **OWNER'S MANUAL**

**▲ Read this manual carefully before operating this outboard motor.**

**6GR-28199-K5-E0**

**Read this manual carefully before operating this outboard motor. Keep this manual onboard in a waterproof bag when boating. This manual should stay with the outboard motor if it is sold.**

# Important manual information

EMU25108

## To the owner

Thank you for selecting a Yamaha outboard motor. This Owner's Manual contains information needed for proper operation, maintenance and care. A thorough understanding of these simple instructions will help you obtain maximum enjoyment from your new Yamaha. If you have any question about the operation or maintenance of your outboard motor, please consult a Yamaha dealer.

In this Owner's Manual particularly important information is distinguished in the following ways.

 : This is the safety alert symbol. It is used to alert you to potential personal injury hazards. Obey all safety messages that follow this symbol to avoid possible injury or death.

EWMM00782

### **WARNING**

**A WARNING indicates a hazardous situation which, if not avoided, could result in death or serious injury.**

ECM00702

### **NOTICE**

**A NOTICE indicates special precautions that must be taken to avoid damage to the outboard motor or other property.**

### **TIP:**

A TIP provides key information to make procedures easier or clearer.

Yamaha continually seeks advancements in product design and quality. Therefore, while this manual contains the most current product information available at the time of printing, there may be minor discrepancies

between your machine and this manual. If there is any question concerning this manual, please consult your Yamaha dealer.

To ensure long product life, Yamaha recommends that you use the product and perform the specified periodic inspections and maintenance by correctly following the instructions in the owner's manual. Any damage resulting from neglect of these instructions is not covered by warranty.

Some countries have laws or regulations restricting users from taking the product out of the country where it was purchased, and it may be impossible to register the product in the destination country. Additionally, the warranty may not apply in certain regions. When planning to take the product to another country, consult the dealer where the product was purchased for further information.

If the product was purchased used, please consult your closest dealer for customer registration, and to be eligible for the specified services.

### **TIP:**

The F375AST, FL375AST, F425AST, FL425AST and the standard accessories are used as a base for the explanations and illustrations in this manual. Therefore some items may not apply to every model.

EMU25123

### **F375A, FL375A, F425A, FL425A OWNER'S MANUAL**

**©2023 by Yamaha Motor Co., Ltd.  
1st Edition, November 2022**

**All rights reserved.**

**Any reprinting or unauthorized use  
without the written permission of  
Yamaha Motor Co., Ltd.  
is expressly prohibited.**

**Printed in Japan**

# Table of contents

---

<b>Safety information</b> .....	<b>1</b>	Digital electronic control requirements.....	12
Outboard motor safety.....	1	Battery requirements .....	13
Propeller.....	1	Battery specifications.....	13
Rotating parts.....	1	Propeller selection .....	14
Hot parts .....	1	Counter rotation models .....	14
Electric shock.....	1	Start-in-gear protection .....	14
Power trim and tilt.....	1	Engine oil requirements .....	15
Engine shut-off cord (lanyard).....	1	Fuel requirements.....	15
Gasoline .....	2	Gasoline .....	15
Gasoline exposure and spills .....	2	Anti-fouling paint .....	16
Carbon monoxide .....	2	Outboard motor disposal requirements.....	16
Modifications.....	2	Emergency equipment.....	16
Boating safety .....	2	Emission control information .....	16
Alcohol and drugs .....	2	U.S. insular areas .....	16
Personal flotation devices (PFDs) .....	2	<b>Components</b> .....	<b>18</b>
People in the water .....	2	Components diagram .....	18
Passengers.....	2	Optional items .....	20
Overloading.....	3	Helm Master™ EX (upgradable) ..	22
Avoid collisions .....	3	Digital electronic control.....	23
Collisions with floating or submerged objects .....	3	Control lever.....	24
Weather .....	4	Power trim and tilt switches.....	24
Passenger training .....	4	DEC alert indicator .....	25
Boating safety publications.....	4	Speed control switch .....	25
Laws and regulations .....	4	Neutral hold switch .....	26
<b>General information</b> .....	<b>5</b>	Station selector switch.....	26
Identification numbers record .....	5	Center engine switch.....	27
Outboard motor serial number.....	5	Single lever switch .....	27
Key number .....	5	Trim Assist switch .....	28
EC Declaration of Conformity (DoC).....	5	6X6 switch .....	28
CE Marking / UKCA Marking .....	5	Main switch .....	28
Compliance mark label .....	6	Start/Stop switch panel.....	29
Read manuals and labels.....	7	All Start/Stop switch panel (optional) .....	29
Warning labels .....	7	Engine shut-off cord (lanyard) and clip .....	29
Engine data recording.....	9	Outboard motor equipment .....	30
<b>Specifications and requirements</b> ...	<b>11</b>	Power trim and tilt switch on bottom cowling .....	30
Specifications.....	11	Tilt limiter .....	30
Installation requirements.....	12		
Boat horsepower rating.....	12		
Mounting outboard motor.....	12		

# Table of contents

Tilt support lever for power trim and tilt model .....	30	Checks after starting engine.....	54
Cowling lock lever .....	31	Cooling water .....	54
Flushing device .....	31	Warming up engine.....	55
Fuel filter.....	32	Procedure for warming up engine....	55
<b>Instruments and indicators .....</b>	<b>33</b>	Checks after engine warm up.....	55
CL5 Display .....	33	Shifting .....	55
<b>Engine control system .....</b>	<b>36</b>	Stop switches.....	55
Alert system .....	36	Shifting.....	55
Helm Master control system alert ...	36	Neutral hold switch operation.....	56
Digital electronic control alert .....	36	Center engine switch operation....	56
Overheat alert.....	36	Single lever switch operation.....	57
Low oil pressure alert.....	37	Stopping boat .....	58
Water separator alert.....	38	Boat direction .....	59
<b>Installation .....</b>	<b>40</b>	Stopping engine.....	61
Installation .....	40	Procedure for stopping engine	
Mounting the outboard motor .....	40	(6X6 switch).....	61
<b>Operation .....</b>	<b>42</b>	Trimming outboard motor.....	61
First-time operation.....	42	Adjusting trim angle (Power trim	
Filling engine oil.....	42	and tilt) .....	62
Breaking in engine.....	42	Adjusting boat trim .....	63
Getting to know your boat .....	42	Tilting up and down .....	63
Checks before starting engine .....	43	Procedure for tilting up (power trim	
Fuel level .....	43	and tilt models) .....	64
Removing top cowling .....	43	Procedure for tilting down.....	65
Fuel system .....	44	Shallow water .....	66
Controls.....	44	Cruising in shallow water .....	66
Engine shut-off cord (lanyard).....	45	Operating in other conditions .....	67
Engine oil.....	45	<b>Maintenance .....</b>	<b>68</b>
Outboard motor .....	45	Transporting and storing	
Flushing device .....	46	outboard motor.....	68
Installing top cowling .....	46	Storing outboard motor.....	68
Checking power trim and tilt		Lubrication .....	69
system .....	47	Flushing cooling water passage.....	69
Battery.....	48	Cleaning the outboard motor .....	70
Filling fuel .....	48	Checking painted surface of	
Operating engine.....	49	outboard motor .....	70
Sending fuel .....	49	Periodic maintenance .....	70
Starting engine .....	49	Replacement parts.....	70
		Severe operating conditions .....	71
		Maintenance chart 1.....	72
		Maintenance chart 2.....	74
		Greasing .....	76

# Table of contents

---

Inspecting spark plug.....	78
Inspecting engine idle speed .....	78
Changing engine oil.....	78
Why Yamalube .....	78
Inspecting wiring and connectors....	78
Inspecting propeller .....	79
Removing propeller .....	79
Installing propeller .....	80
Changing gear oil .....	80
Inspecting and replacing anode(s) ...	82
Checking battery (for electric start models) .....	83
Connecting the battery.....	83
Disconnecting the battery .....	85
<b>Trouble Recovery .....</b>	<b>87</b>
Troubleshooting .....	87
Temporary action in emergency ...	90
Impact damage .....	90
Running in an emergency (twin engines or triple engines) .....	90
Replacing fuse .....	91
Power trim and tilt will not operate.....	92
Steer-by-wire system will not operate.....	92
Water separator-alert is activated after leaving port.....	93
Treatment of submerged motor ....	94
<b>INDEX .....</b>	<b>96</b>

EMU33623

## Outboard motor safety

Observe these precautions at all times.

EMU36502

### Propeller

People can be injured or killed if they come in contact with the propeller. The propeller can keep moving even when the motor is in neutral, and sharp edges of the propeller can cut even when stationary.

- Stop the engine when a person is in the water near you.
- Keep people out of reach of the propeller, even when the engine is off.

EMU40272

### Rotating parts

Hands, feet, hair, jewelry, clothing, personal flotation device (PFD) straps, etc., can become entangled with internal rotating parts of the engine, resulting in serious injury or death.

Keep the top cowling in place whenever possible. Do not remove or replace the top cowling with the engine running.

Only operate the engine with the top cowling removed according to the specific instructions in the manual. Keep hands, feet, hair, jewelry, clothing, PFD straps, etc., away from any exposed moving parts.

EMU33641

### Hot parts

During and after operation, engine parts are hot enough to cause burns. Avoid touching any parts under the top cowling until the engine has cooled.

EMU33651

### Electric shock

Do not touch any electrical parts while starting or operating the engine. They can cause shock or electrocution.

EMU33662

### Power trim and tilt

Body parts can be crushed between the motor and the clamp bracket when the motor is trimmed or tilted. Keep body parts out of this area at all times. Be sure no one is in this area before operating the power trim and tilt mechanism.

The power trim and tilt switches operate even when the main switch is off. Keep people away from the switches whenever working around the motor.

Never get under the lower unit while it is tilted, even when the tilt support lever is locked. Severe injury could occur if the outboard motor accidentally falls.

EMU33672

### Engine shut-off cord (lanyard)

Attach the engine shut-off cord so that the engine stops if the operator falls overboard or leaves the helm. This prevents the boat from running away under power and leaving people stranded, or running over people or objects.

Always attach the engine shut-off cord to a secure place on your clothing or your arm or leg while operating. Do not remove it to leave the helm while the boat is moving. Do not attach the cord to clothing that could tear loose, or route the cord where it could become entangled, preventing it from functioning.

Do not route the cord where it is likely to be accidentally pulled out. If the cord is pulled during operation, the engine will shut off and you will lose most steering control. The boat could slow rapidly, throwing people and objects forward.

# Safety information

---

EMU33811

## Gasoline

**Gasoline and its vapors are highly flammable and explosive.** Always, refuel according to the procedure on page 49 to reduce the risk of fire and explosion.

EMU33821

## Gasoline exposure and spills

Take care not to spill gasoline. If gasoline spills, wipe it up immediately with dry rags. Dispose of rags properly.

If any gasoline spills onto your skin, immediately wash with soap and water. Change clothing if gasoline spills on it.

If you swallow gasoline, inhale a lot of gasoline vapor, or get gasoline in your eyes, get immediate medical attention. Never siphon fuel by mouth.

EMU33901

## Carbon monoxide

This product emits exhaust gases which contain carbon monoxide, a colorless, odorless gas which may cause brain damage or death when inhaled. Symptoms include nausea, dizziness, and drowsiness. Keep cockpit and cabin areas well ventilated. Avoid blocking exhaust outlets.

EMU33781

## Modifications

Do not attempt to modify this outboard motor. Modifications to your outboard motor may reduce safety and reliability, and render the outboard unsafe or illegal to use.

EMU33742

## Boating safety

This section includes a few of the many important safety precautions that you should follow when boating.

EMU33711

## Alcohol and drugs

Never operate after drinking alcohol or taking drugs. Intoxication is one of the most common factors contributing to boating fatalities.

EMU40281

## Personal flotation devices (PFDs)

Have an approved PFD on board for every occupant. Yamaha recommends that you must wear a PFD whenever boating. At a minimum, children and non-swimmers should always wear PFDs, and everyone should wear PFDs when there are potentially hazardous boating conditions.

EMU33732

## People in the water

Always watch carefully for people in the water, such as swimmers, skiers, or divers, whenever the engine is running. When someone is in the water near the boat, shift into neutral and stop the engine.

Stay away from swimming areas. Swimmers can be hard to see.

The propeller can keep moving even when the motor is in neutral. Stop the engine when a person is in the water near you.

EMU33752

## Passengers

Consult your boat manufacturer's instructions for details about appropriate passenger locations in your boat and be sure all passengers are positioned properly before accelerating and when operating above an idle speed. Standing or sitting in non-designated locations may result in being thrown either overboard or within the boat due to waves, wakes, or sudden changes in speed or direction. Even when people are positioned prop-



erly, alert your passengers if you must make any unusual maneuver. Always avoid jumping waves or wakes.

EMU33763

## Overloading

Do not overload the boat. Consult the boat capacity plate or boat manufacturer for maximum weight and number of passengers. Be sure that weight is properly distributed according to the boat manufacturer's instructions. Overloading or incorrect weight distribution can compromise the boat's handling and lead to an accident, capsizing or swamping.

EMU33773

## Avoid collisions

Scan constantly for people, objects, and other boats. Be alert for conditions that limit your visibility or block your vision of others.

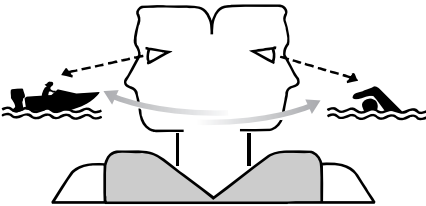

ZMU06025

Operate defensively at safe speeds and keep a safe distance away from people, objects, and other boats.

- Do not follow directly behind other boats or waterskiers.
- Avoid sharp turns or other maneuvers that make it hard for others to avoid you or understand where you are going.
- Avoid areas with submerged objects or shallow water.

- Ride within your limits and avoid aggressive maneuvers to reduce the risk of loss of control, ejection, and collision.
- Take early action to avoid collisions. Remember, boats do not have brakes, and stopping the engine or reducing throttle can reduce the ability to steer. If you are not sure that you can stop in time before hitting an obstacle, apply throttle and turn in another direction.

EMU48100

## Collisions with floating or submerged objects

If the outboard motor hits a floating object or an obstacle in the water while cruising, the following could occur:

- The passengers and any loose equipment or luggage could be thrown forward due to the sudden deceleration.
- Parts of the outboard motor could come loose as a result of the impact and could be thrown into the boat.
- The boat or outboard motor could be damaged as a result of the impact.

When you operate the boat in an area where there might be floating objects or obstacles in the water, be sure to adjust the trim angle of the outboard motor, slow down, and operate carefully. For further information, see page 66.

If the outboard motor hits a floating object or an obstacle in the water, make sure that there are no abnormalities with the boat and the outboard motor. If anything abnormal is found, return to the nearest harbor at low speed and have a Yamaha dealer inspect the outboard motor.

# Safety information

---

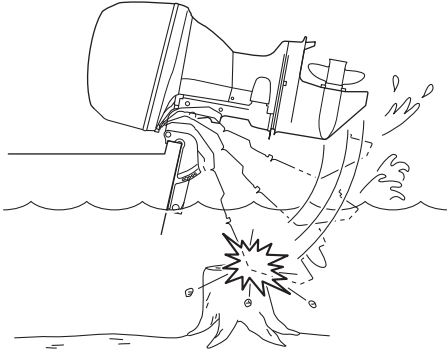

EMU33791

## **Weather**

Stay informed about the weather. Check weather forecasts before boating. Avoid boating in hazardous weather.

EMU33881

## **Passenger training**

Make sure at least one other passenger is trained to operate the boat in the event of an emergency.

EMU33891

## **Boating safety publications**

Be informed about boating safety. Additional publications and information can be obtained from many boating organizations.

EMU33602

## **Laws and regulations**

Know the marine laws and regulations where you will be boating—and obey them. Several sets of rules prevail according to geographic location, but all are basically the same as the International Rules of the Road.

EMU25172

## Identification numbers record

EMU25186

### Outboard motor serial number

The outboard motor serial number is stamped on the label attached to the port side of the clamp bracket.

Record your outboard motor serial number in the spaces provided to assist you in ordering spare parts from your Yamaha dealer or for reference in case your outboard motor is stolen.

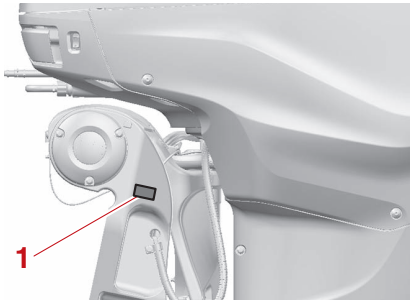

1. Outboard motor serial number location

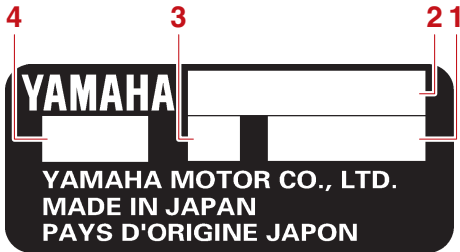

ZMU01692

1. Serial number
2. Model name
3. Motor transom height
4. Engine code

EMU41572

### Key number

The key identification number is stamped on the spare key as shown in the illustration. Keep the spare key in a safe place and record this number in the space provided for reference in case that you need a new key.

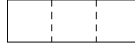

ZMU01693

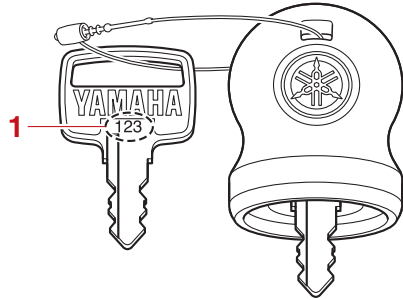

1. Key number

EMU38984

## EC Declaration of Conformity (DoC)

This declaration is included with outboard motors that conform to European regulations.

This outboard motor conforms to certain portions of the European Parliament directive relating to machinery.

Each conformed outboard motor accompanied with EC DoC. EC DoC contains the following information;

- Manufacturer
- Model name
- Engine code
- Applied directives

EMU48442

## CE Marking / UKCA Marking

This label is affixed to outboard motors that conform to European regulations.

# General information

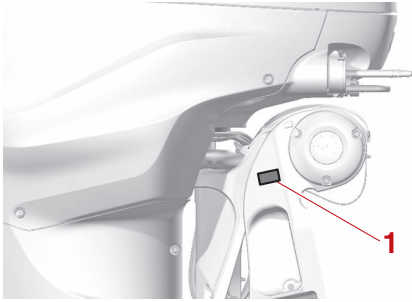

1. CE marking location

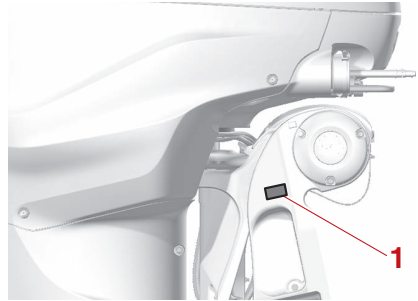

1. Compliance mark label location



## CE marking

Outboard motors affixed with this “CE” marking conform with the directives of; 2006/42/EC, 2014/30/EU, and 2013/53/EU.

## UKCA marking

This product is in compliance with the Recreational Craft Regulations 2017, Electromagnetic Compatibility Regulations 2016 and Supply of Machinery (Safety) Regulations 2008.

EMU46133

## Compliance mark label

Engines affixed with this label conform to the regulations for each country.

This label is affixed to the clamp bracket or swivel bracket.

## Regulatory Compliance Mark (RCM)

Engines affixed with this mark conform to certain portion(s) of the Australian Radio Communications Act.

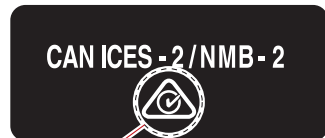

1

ZMU08190

1. Regulatory Compliance Mark (RCM)

## ICES-002 Compliance Label

Engines affixed with this mark meet all requirements of the Canadian Interference Causing Equipment Regulations.



1

ZMU08191

1. ICES-002 Compliance Label

EMU33524

## Read manuals and labels

Before operating or working on this outboard motor:

- Read this manual.
- Read any manuals supplied with the boat.
- Read all labels on the outboard motor and the boat.

If you need any additional information, contact your Yamaha dealer.

EMU33836

## Warning labels

If these labels are damaged or missing, contact your Yamaha dealer for replacements.

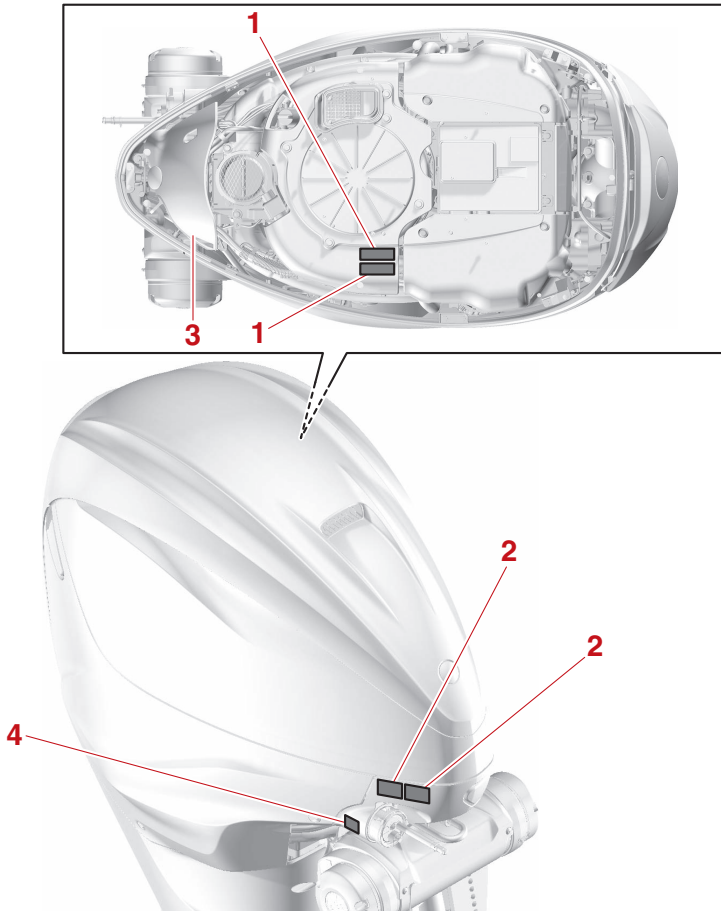

# General information

1

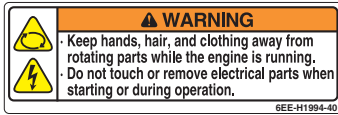

2

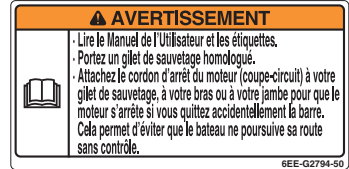
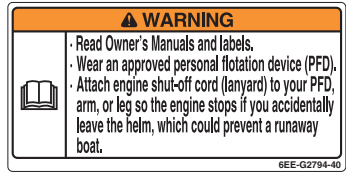

3



EMU47890

## Contents of labels

The above warning labels mean as follows.

1

EWM01682



### WARNING

- Keep hands, hair, and clothing away from rotating parts while the engine is running.
- Do not touch or remove electrical parts when starting or during operation.

2

EWM01672



### WARNING

- Read Owner's Manuals and labels.
- Wear an approved personal flotation device (PFD).

- Attach engine shut-off cord (lanyard) to your PFD, arm, or leg so the engine stops if you accidentally leave the helm, which could prevent a runaway boat.

3

EWM04450



### WARNING

Vapor separator tank (VST) contains pressurized fuel.

To reduce the risk of spraying fuel during VST service:

1. Wrap fuel hose connector in a cloth then disconnect hose slowly to release pressure.
2. Remove band from fuel nipple.
3. Open drain cap to drain the fuel from VST.

EMU33851

## Other labels

4



Hazard caused by continuous rotation



ZMU05665

EMU35133

## Symbols

The following symbols mean as follows.

Notice/Warning



ZMU05696

Read Owner's Manual

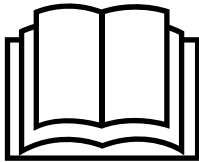

ZMU05664

Electrical hazard

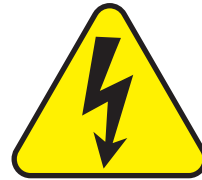

ZMU05666

EMU48010

## Engine data recording

This model's ECM stores certain engine data to assist in the diagnosis of malfunctions and for research, statistical analysis and development purposes.

Although the sensors and recorded data will vary by model, the main data points are:

- Engine status and engine performance data

This data will be uploaded only when a special Yamaha diagnostic tool is attached to the engine, such as when maintenance checks or service procedures are performed.

Yamaha will not disclose this data to a third party except in the following cases. In addition, Yamaha may provide engine data to a contractor in order to outsource services related to the handling of the engine data. Even

# General information

---

in this case, Yamaha will require the contractor to properly handle the engine data we provided and Yamaha will appropriately manage the data.

- With the consent of the boat owner
- Where obligated by law
- For use by Yamaha in litigation
- For general Yamaha-conducted research purposes when the data is not related to an individual engine or owner



# Specifications and requirements

EMU40501

## Specifications

### TIP:

“(SUS)” indicates that the specification is for the outboard motor when it is equipped with a stainless steel propeller.

EMU48361

### Dimension and weight:

Overall length:

1217 mm (47.9 in)

Overall width:

652 mm (25.7 in)

Overall height X:

2059 mm (81.1 in)

Overall height U:

2186 mm (86.1 in)

Motor transom height X:

640 mm (25.2 in)

Motor transom height U:

767 mm (30.2 in)

Dry weight (SUS) X:

442 kg (974 lb)

Dry weight (SUS) U:

453 kg (999 lb)

### Performance:

Full throttle operating range:

5000–6000 r/min

Rated power:

279.6 kW (375 HP) (F375AST,  
FL375AST)

316.9 kW (425 HP) (F425AST,  
FL425AST)

Idle speed (in neutral):

650–750 r/min

### Power unit:

Type:

4-stroke DOHC V8 32 valves

Total displacement:

5559 cm<sup>3</sup> (339.2 c.i.)

Bore × stroke:

96.0 × 96.0 mm (3.78 × 3.78 in)

Ignition system:

TCI

Spark plug (NGK):

ILMAR7E-9

Spark plug gap:

0.8–0.9 mm (0.031–0.035 in)

Steering system:

Remote steering

Starting system:

Electric starter

Starting carburetion system:

Fuel injection

Valve clearance IN (cold engine):

0.17–0.24 mm (0.0067–0.0094 in)

Valve clearance EX (cold engine):

0.37–0.44 mm (0.0146–0.0173 in)

Battery rating (CCA/SAE):

700 A

Battery rating (MCA/ABYC):

900 A

Battery rating (RC/SAE):

170 minutes

Battery rating (CCA/EN):

670 A

Battery rating (20HR/IEC):

110 Ah

Maximum generator output:

104 A

### Lower unit:

Gear shift positions:

Forward-neutral-reverse

Gear ratio:

1.79 (25/14)

Trim and tilt system:

Power trim and tilt

Propeller mark:

Y (F375AST, F425AST)

YL (FL375AST, FL425AST)

# Specifications and requirements

---

## Fuel and oil:

Recommended fuel:

Premium unleaded gasoline

Min. pump octane number (PON):

89

Min. research octane number (RON):

94

Recommended engine oil:

YAMALUBE 4 or 4-stroke outboard motor oil



Recommended engine oil grade 1:

SAE 10W-30/10W-40/5W-30

API SG/SH/SJ/SL

Engine oil quantity (without oil filter replacement):

7.5 L (7.93 US qt, 6.60 Imp.qt)

Engine oil quantity (with oil filter replacement):

7.8 L (8.24 US qt, 6.86 Imp.qt)

Lubrication system:

Wet sump

Recommended gear oil:

YAMALUBE outboard gear oil or Hypoid gear oil

Recommended gear oil grade:

SAE 80W API GL-5 / SAE 90 API GL-5

Gear oil quantity:

1.830 L (1.934 US qt, 1.610 Imp.qt)

(FL375AST, FL425AST)

1.950 L (2.061 US qt, 1.716 Imp.qt)

(F375AST, F425AST)

## Noise and vibration level:

Operator sound pressure level (ICOMIA 39/94):

90.9 dB(A)

EMU33556

## Installation requirements

EMU33566

### Boat horsepower rating

EWM01561



**WARNING**

**Overpowering a boat can cause severe instability.**

Before installing the outboard motor(s), confirm that the total horsepower of your outboard motor(s) does not exceed the boat's maximum horsepower rating. See the boat's capacity plate or contact the manufacturer.

EMU40491

### Mounting outboard motor

EWM02501



**WARNING**

- **Improper mounting of the outboard motor could result in hazardous conditions such as poor handling, loss of control, or fire hazards.**
- **Because the outboard motor is very heavy, special equipment and training is required to mount it safely.**

Your dealer or other person experienced in proper rigging should mount the outboard motor using correct equipment and complete rigging instructions. For further information, see page 40.

EMU34954

### Digital electronic control requirements

The digital electronic control is equipped with a start-in-gear protection device(s). This device prevents the engine from starting unless it is in neutral.

# Specifications and requirements

EWM01581



- If the engine starts in gear, the boat can move suddenly and unexpectedly, possibly causing a collision or throwing passengers overboard.
- If the engine ever starts in gear, the start-in-gear protection device is not working correctly and you should discontinue using the outboard. Contact your Yamaha dealer.

This digital electronic control unit is only available for the outboard motor which you have purchased.

Prior to use of the digital electronic control unit, set it in order to operate your outboard motor only. Otherwise, it will not be possible to operate the outboard motor.

Perform setting of the outboard motor and the digital electronic control unit in the following cases.

- If a used outboard motor is installed
- If the digital electronic control unit is replaced
- If the ECM (Electronic control module) of the used outboard motor is replaced
- If the ECM (Electronic control module) of the digital electronic control unit is replaced

Consult your Yamaha dealer for setting.

EMU25695

## Battery requirements

EMU44881

### Battery specifications

#### For U.S. insular areas

It is necessary to meet only two of the three specifications (CCA, MCA, and RC) in one of the following combinations:

- CCA/SAE and RC
- MCA/ABYC and RC

#### Battery rating (CCA/SAE):

700 A

#### Battery rating (MCA/ABYC):

900 A

#### Battery rating (RC/SAE):

170 minutes

#### For Others

#### Battery rating (CCA/EN):

670 A

#### Battery rating (20HR/IEC):

110 Ah

The engine cannot be started if battery voltage is too low.

EMU36293

### Mounting battery

Mount the battery holder securely in a dry, well-ventilated, vibration-free location in the boat. **WARNING! Do not put flammable items, or loose heavy or metal objects in the same compartment as the battery. Fire, explosion or sparks could result.**

[EWM01821]

### Battery cable

The battery cable size and length are critical. Consult your Yamaha dealer about the battery cable size and length.

EMU36303

### Multiple batteries

To connect multiple batteries, such as for multiple engine configurations or for an accessory battery, consult your Yamaha dealer about battery selection and correct wiring.

### Battery isolator

Your outboard motor is capable of charging an accessory battery separate from the starting battery using an optional isolator lead.

# Specifications and requirements

Contact your Yamaha dealer for installation of an optional isolator lead with over-current protection.

EMU41604

## Propeller selection

Next to selecting an outboard motor, selecting the right propeller is one of the most important purchasing decisions a boater can make. The type, size, and design of your propeller have a direct impact on acceleration, top speed, fuel economy, and even engine life. Yamaha designs and manufactures propellers for every Yamaha outboard motor and every application.

Your Yamaha dealer can help you select the right propeller for your boating needs. Select a propeller that will allow the engine to reach the middle or upper half of the operating range at full throttle with the maximum boatload. Generally, select a larger pitch propeller for a smaller operating load and a smaller pitch propeller for a heavier load. If you carry loads that vary widely, select the propeller that lets the engine run in the proper range for your maximum load but remember that you may need to reduce your throttle setting to stay within the recommended engine speed range when carrying lighter loads.

Yamaha recommends to use a propeller suitable for the "Shift Dampener System (SDS)". For further information, consult your Yamaha dealer.

To check the propeller, see page 79.

## Propeller example

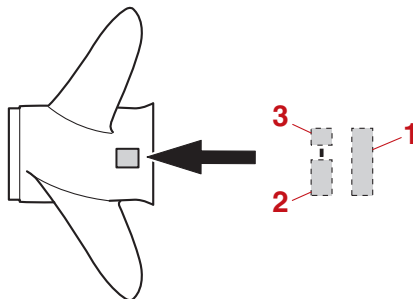

1. Propeller diameter in inches
2. Propeller pitch in inches
3. Type of propeller (propeller mark)

EMU36313

## Counter rotation models

Standard outboard motors rotate clockwise. Counter rotation models rotate counterclockwise and are typically used in multiple motor setups.

On counter rotation models, be sure to use a propeller intended for counterclockwise rotation. These propellers are identified with the letter "L" after the size indication on the propeller. **WARNING! Never use a standard propeller with a counter rotation motor, or a counter rotation propeller with a standard motor. Otherwise the boat could go in the direction opposite of that expected (for example, reverse instead of forward), which could lead to an accident.** [EWM01811]

For instructions on propeller removal and installation, see page 79.

EMU35141

## Start-in-gear protection

Yamaha outboard motors or Yamaha-approved digital electronic control units are equipped with start-in-gear protection device(s). This feature permits the engine to be started only when it is in neutral. Always select neutral before starting the engine.

# Specifications and requirements

EMU41953

## Engine oil requirements

Select an oil grade according to the average temperatures in the area where the outboard motor will be used.

### Recommended engine oil:

YAMALUBE 4 or 4-stroke outboard motor oil

### Recommended engine oil grade 1:

SAE 10W-30/10W-40/5W-30  
API SG/SH/SJ/SL

### Recommended engine oil grade 2:

SAE 15W-40/20W-40/20W-50  
API SH/SJ/SL

Engine oil quantity (without oil filter replacement):

7.5 L (7.93 US qt, 6.60 Imp.qt)

Engine oil quantity (with oil filter replacement):

7.8 L (8.24 US qt, 6.86 Imp.qt)

If oil grades listed under Recommended engine oil grade 1 are not available, select an alternative oil grade listed under Recommended engine oil grade 2.

### Recommended engine oil grade 1

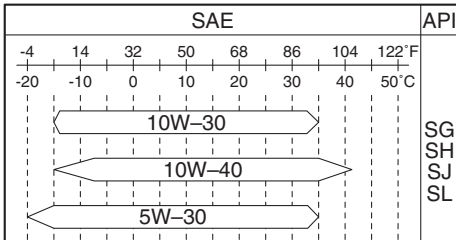

ZMU08143

## Recommended engine oil grade 2

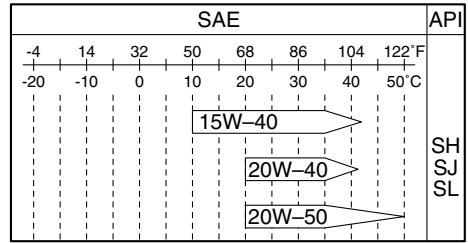

ZMU06855

EMU36361

## Fuel requirements

EMU49280

### Gasoline

Use a good quality gasoline that meets the minimum octane rating. If knocking or pinging occurs, use a different brand of gasoline or premium unleaded fuel.

Yamaha recommends that you use alcohol-free gasoline (see Gasohol) whenever possible.

### Recommended fuel:

Premium unleaded gasoline

#### Min. pump octane number (PON):

89

#### Min. research octane number (RON):

94

ECM01982

### NOTICE

- Do not use leaded gasoline. Leaded gasoline can seriously damage the engine.
- Avoid getting water and contaminants in the fuel tank. Contaminated fuel can cause poor performance or engine damage. Use only fresh gasoline that has been stored in clean containers.

# Specifications and requirements

## Gasohol

There are two types of gasohol: gasohol containing ethanol (E10) and that containing methanol. Ethanol can be used if the ethanol content does not exceed 10% and the fuel meets the minimum octane ratings. All ethanol blends containing more than 10% ethanol can cause fuel system damage or cause engine starting and running problems. Yamaha does not recommend gasohol containing methanol because it can cause fuel system damage or engine performance problems.

EMU36331

## Anti-fouling paint

A clean hull improves boat performance. The boat bottom should be kept as clean of marine growth as possible. If necessary, the boat bottom can be coated with an anti-fouling paint approved for your area to inhibit marine growth.

Do not use anti-fouling paint which includes copper or graphite. These paints can cause more rapid engine corrosion.

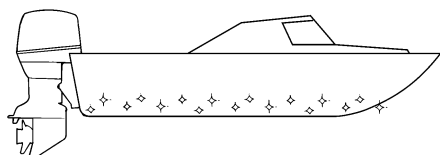

ZMU05176

EMU40302

## Outboard motor disposal requirements

Never illegally discard (dump) the outboard motor. Yamaha recommends consulting the dealer about discarding the outboard motor.

EMU36353

## Emergency equipment

Keep the following items onboard in case there is trouble with the outboard motor.

- A tool kit with assorted screwdrivers, pliers, wrenches (including metric sizes), and electrical tape.
- Waterproof flashlight with extra batteries.
- An extra engine shut-off cord (lanyard) with clip.
- Spare parts, such as an extra set of spark plugs.

Consult your Yamaha dealer for details.

EMU25223

## Emission control information

EMU25311

### U.S. insular areas

Engines affixed with the label pictured below conform to U.S. Environmental Protection Agency (EPA) regulations for marine SI engines. See the label affixed to your engine for details.

EMU47930

### Approval label of emission control certificate

This label is attached at the location shown. New Technology; (4-stroke) DFI

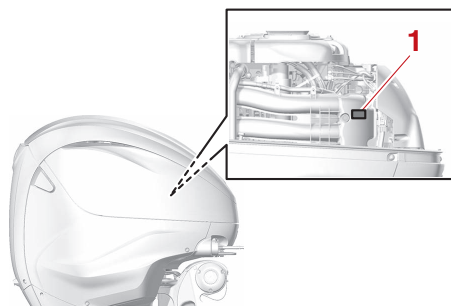

1. Approval label location

# Specifications and requirements

<b>EMISSION CONTROL INFORMATION</b> [-----]		
THIS ENGINE CONFORMS TO [---]; CALIFORNIA EXHAUST AND U.S. EPA EXHAUST AND EVAP REGULATIONS FOR SI MARINE ENGINES. REFER TO OWNER'S MANUAL FOR MAINTENANCE SPECIFICATIONS AND ADJUSTMENTS.		
FAMILY : [-----]	EPA FEL : HC+NOx [---], CO [---] g/kW-h	<b>YAMAHA</b>
MAX POWER : [---] kW	CA FEL : HC+NOx [-----] g/kW-h	
DISPLACEMENT : [---] liters		
EPA CERTIFIED EVAP COMPONENTS :		
<b>YAMAHA MOTOR CO.,LTD.</b> [-----]		

# Components

EMU48680

## Components diagram

### TIP:

\* May not be exactly as shown; also may not be included as standard equipment on all models (order from dealer).

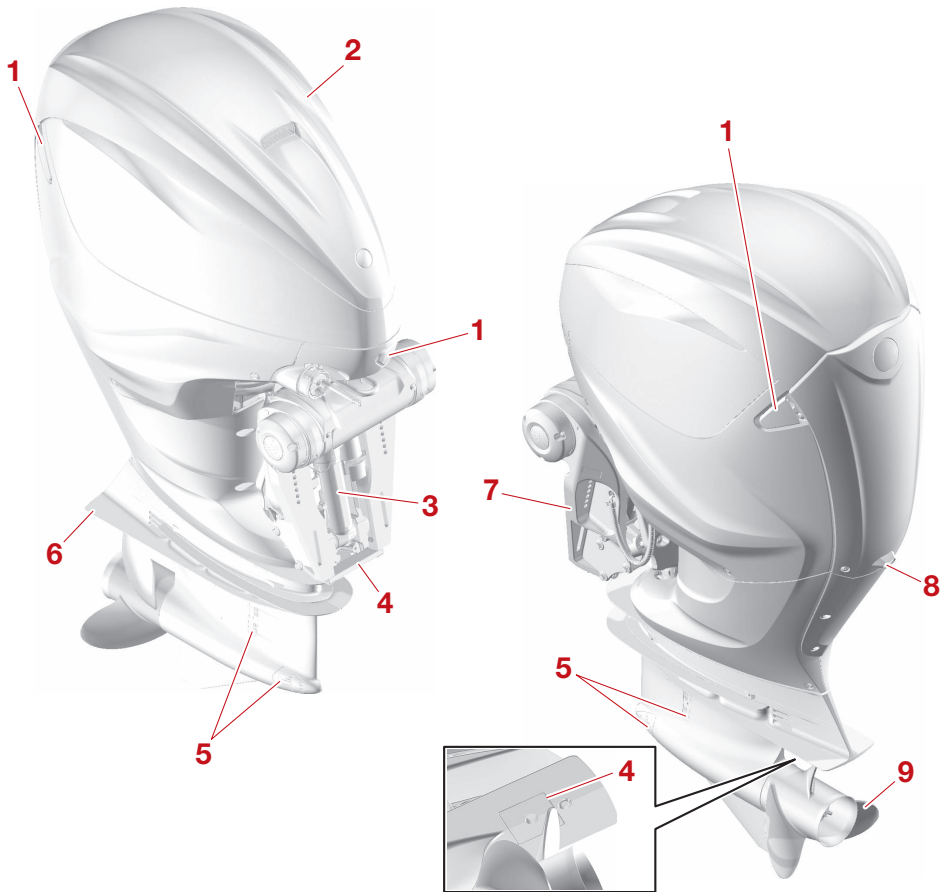

1. Cowling lock lever
2. Top cowling
3. Power trim and tilt unit
4. Anode
5. Cooling water inlet
6. Anti-cavitation plate
7. Clamp bracket
8. Idle hole

9. Propeller\*



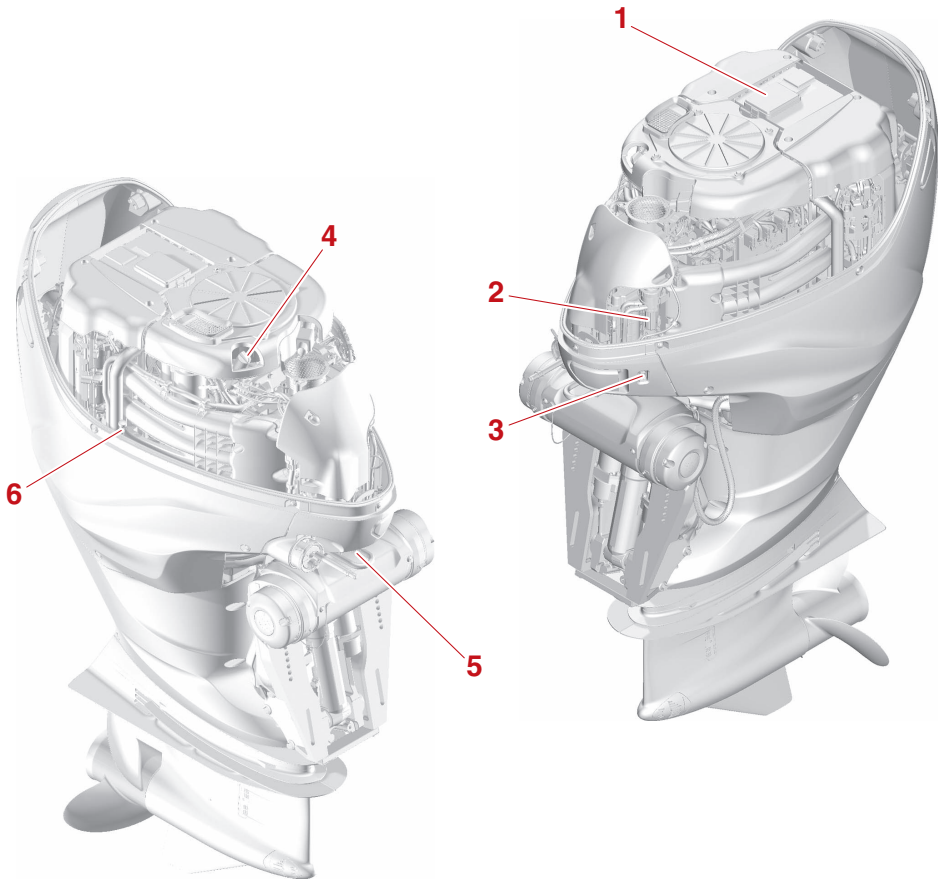

1. Fuse box
2. Fuel filter
3. Power trim and tilt switch
4. Oil filler cap
5. Flushing device
6. Oil dipstick

# Components

EMU46733

## Optional items

The following items are available from your Yamaha dealer. For details, consult your Yamaha dealer.

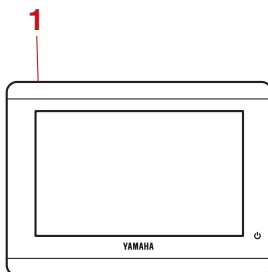

### 1. CL5 Display

#### For single-engine boats

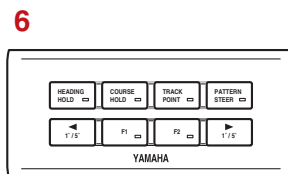
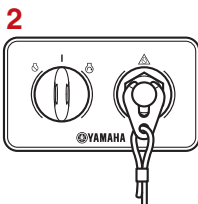
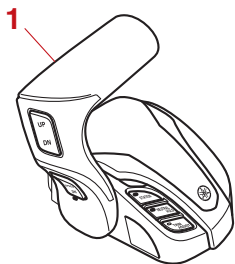

1. Digital electronic control
2. Switch panel
3. Start/Stop switch panel (sub station)
4. Engine shut-off switch panel (sub station)
5. Joystick (upgradable)
6. Autopilot (upgradable)

## For twin-engine boats

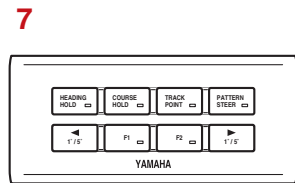
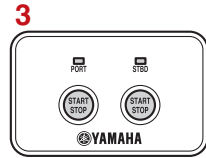
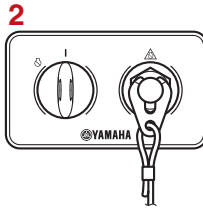
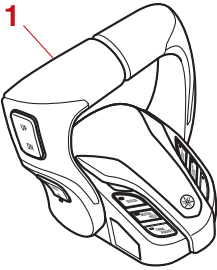

1. Digital electronic control
2. Switch panel
3. Start/Stop switch panel
4. All Start/Stop switch panel
5. Engine shut-off switch panel (sub station)
6. Joystick (upgradable)
7. Autopilot (upgradable)

# Components

For triple-engine boats

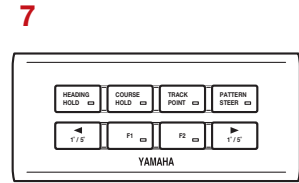
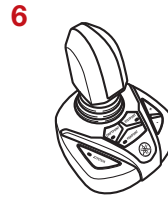
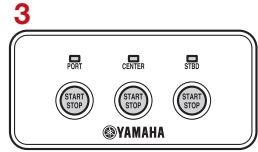
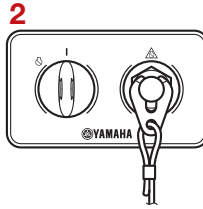
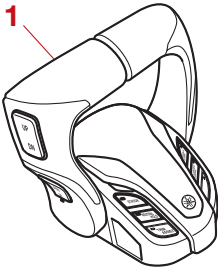

1. Digital electronic control
2. Switch panel
3. Start/Stop switch panel
4. All Start/Stop switch panel
5. Engine shut-off switch panel (sub station)
6. Joystick (upgradable)
7. Autopilot (upgradable)

EMU48695

## Helm Master™ EX (upgradable)

### TIP:

For further information about the Helm Master EX, consult your Yamaha dealer.

### Joystick

Because the joystick allows you to move the boat laterally left or right or pivot it 360 degrees in place using the single joystick lever, you can maneuver the boat easily when leaving or arriving at a dock or when traveling in narrow waterways or other tight spaces, such as in marinas.



## Autopilot

The Autopilot supports steering operations, allowing you to keep correct bow direction and travel while maintaining a constant route.

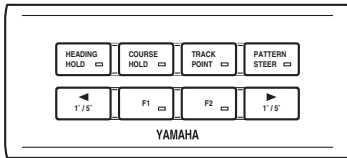

EMU48461

## Digital electronic control

The digital electronic control actuates the shifter, throttle and remote electrical operations. Make sure that the digital electronic control-alert indicator lights in blue and that the digital electronic control unit is correctly connected to the outboard motor. The digital electronic controls of the main station and sub station have the same functions.

### TIP:

This manual mainly covers basic operation. For more information, see the 6X9 DIGITAL ELECTRONIC CONTROL operation manual.

## Single engine

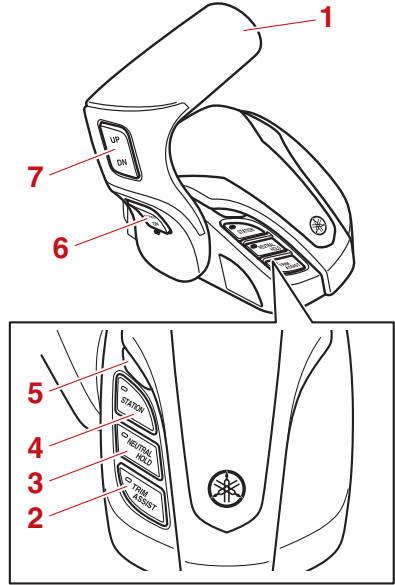

1. Control lever
2. "TRIM ASSIST" switch
3. "NEUTRAL HOLD" switch
4. "STATION" switch
5. DEC alert indicator
6. Speed control switch
7. Power trim and tilt switch

# Components

## Twin engines / Triple engines

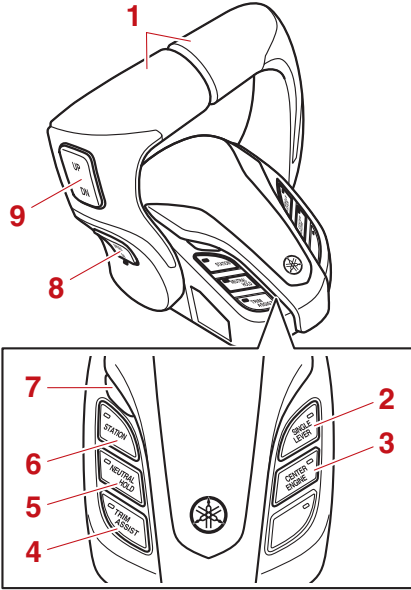

1. Control lever
2. "SINGLE LEVER" switch
3. "CENTER ENGINE" switch (triple engines)
4. "TRIM ASSIST" switch
5. "NEUTRAL HOLD" switch
6. "STATION" switch
7. DEC alert indicator
8. Speed control switch
9. Power trim and tilt switch (all engines)

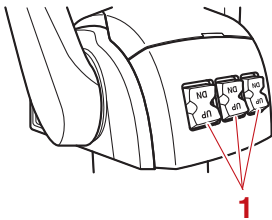

1. Power trim and tilt switch (individual engine)

EMU48471

## Control lever

Lowering the lever from the neutral position to the bow side 22.5° (a detent can be felt) engages the forward gear. Lowering the lever to the stern side engages the reverse gear and the engine begins to run at the lowest speed. Lowering the lever farther opens the throttle, and the engine will begin to accelerate.

### TIP:

You can adjust the resistance of the control lever movement. For further information, see the 6X9 DIGITAL ELECTRONIC CONTROL operation manual.

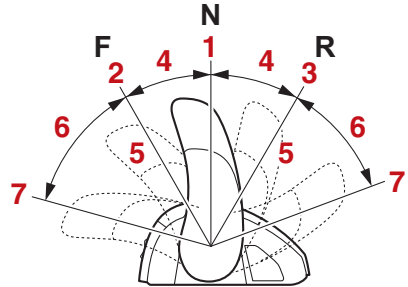

1. Neutral "N"
2. Forward "F"
3. Reverse "R"
4. Shift
5. Fully closed
6. Throttle
7. Fully open

EMU48480

## Power trim and tilt switches

Pushing the switch "UP" (up) trims the outboard motor up, and then tilts it up. Pushing the switch "DN" (down) tilts the outboard motor down and trims it down. When the switch is released, the outboard motor will stop in its current position.

For multiple engine applications, the switch on the control lever controls all outboard motors at the same time.

## Single engine

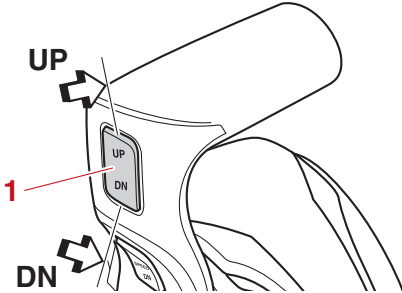

1. Power trim and tilt switch

## Twin engines / Triple engines

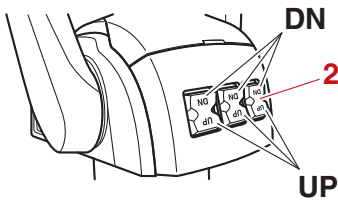
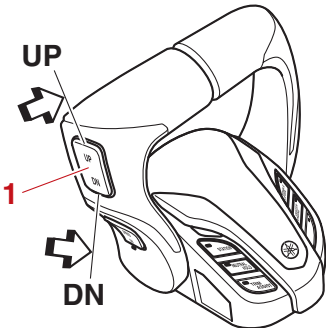

1. Power trim and tilt switch (all engines)
2. Power trim and tilt switch (individual engine)

EMU48491

## DEC alert indicator

The alert indicator changes from blue to orange if a connection problem between the digital electronic control and the outboard

motor occurs. A beep also sounds (repeatedly on and off) to alert the operator. For more information, consult your Yamaha dealer.

## Single engine

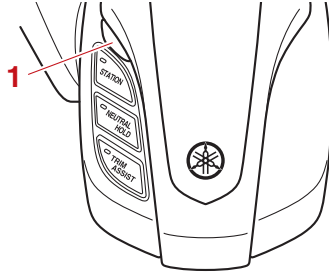

1. DEC alert indicator

## Twin engines / Triple engines

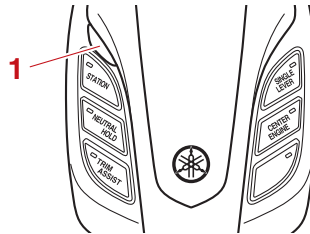

1. DEC alert indicator

EMU48503

## Speed control switch

There are two modes for keeping the engine speed and speed. Pressing the "UP" (up) / "DN" (down) switch enables you to keep the engine speed or to adjust the speed.

# Components

## Single engine

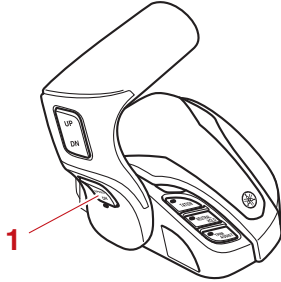

1. Speed control switch

## Twin engines / Triple engines

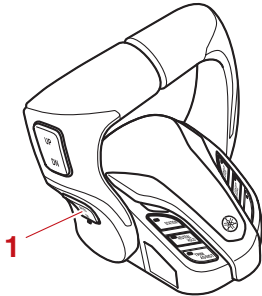

1. Speed control switch

EMU48512

### Neutral hold switch

When the “NEUTRAL HOLD” switch is pressed, the buzzer will sound and the LED will come on. You will be able to open or close the throttle with the shift control in neutral. This can also be done when the control lever is set in reverse. For further information, see page 56.

## Single engine

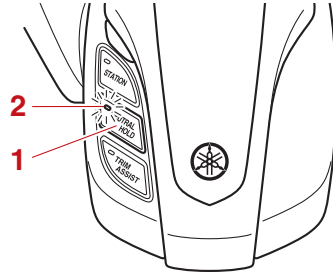

1. “NEUTRAL HOLD” switch
2. LED

## Twin engines / Triple engines

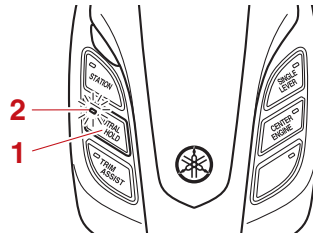

1. “NEUTRAL HOLD” switch
2. LED

EMU48531

### Station selector switch

The “STATION” switch can select either the main station or sub station for operating the boat.

The “STATION” switch can be used when the control lever is in the “N” (neutral) position. The LED for the operating seat that can operate the boat comes on.

### TIP:

- Even the not-selected station can start and stop the engine.
- The LED blinks 3 times if station selection fails.



## Single engine

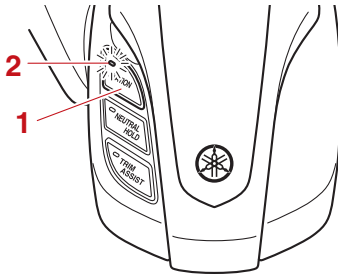

1. "STATION" switch
2. LED

## Triple engines

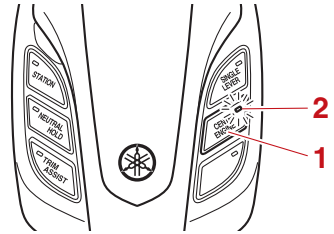

1. "CENTER ENGINE" switch
2. LED

## Twin engines / Triple engines

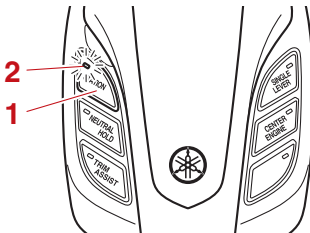

1. "STATION" switch
2. LED

EMU48543

### Center engine switch

When the "CENTER ENGINE" switch is pressed while all engines have been started, the buzzer will sound and the LED will come on. While the LED is lit, the port side control lever allows you to perform shift and throttle operations for the center engine only. For further information, see page 56.

EMU48550

### Single lever switch

For multiple engines, when the "SINGLE LEVER" switch is pressed, the buzzer will sound, the LED will come on, and the port side control lever will allow you to perform shift and throttle operations for all outboard motors that have been started. For further information, see page 57.

#### TIP:

- When the single lever switch is activated, the starboard control lever is inoperable.
- You must start all the engines to enable the single lever switch.

## Twin engines / Triple engines

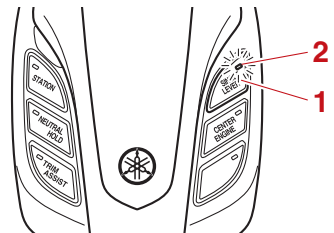

1. "SINGLE LEVER" switch
2. LED

# Components

EMU49271

## Trim Assist switch

This function automatically sets the outboard motor trim angle according to the engine speed.

Enabling the trim assist switch allows the trim assist function to operate.

### TIP:

For more information on the “Trim Assist” function, see the 6X9 DIGITAL ELECTRONIC CONTROL operation manual.

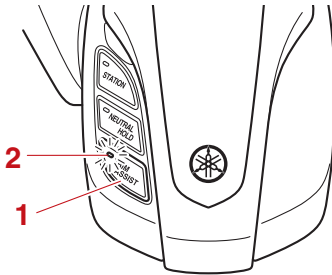

1. “TRIM ASSIST” switch
2. LED

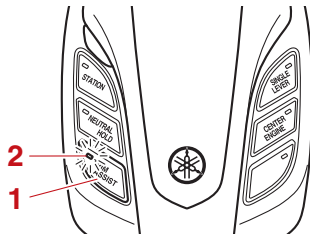

1. “TRIM ASSIST” switch
2. LED

### To set

When the “TRIM ASSIST” switch is pressed, the beep sounds and the LED turns on.

### To release

When the “TRIM ASSIST” switch is pressed, the beep sounds and the LED turns off.

EMU48643

## 6X6 switch

EMU41554

### Main switch

The main switch controls the ignition system; its operation is described below.

#### ● “OFF” (off)

With the main switch in the “OFF” (off) position, the electrical circuits are off, and the key can be removed.

#### ● “ON” (on)

With the main switch in the “ON” (on) position, the electrical circuits are on, and the key cannot be removed. The engine can be started by pressing the Start/Stop button.

#### ● “START” (start)

With the main switch in the “START” (start) position, the starter motor turns to start the engine. When the key is released, it returns automatically to the “ON” (on) position.

### Single engine

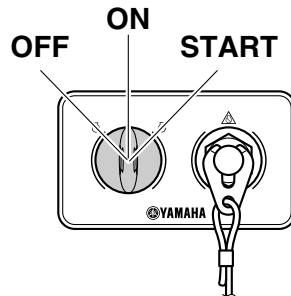

### Twin engines / Triple engines

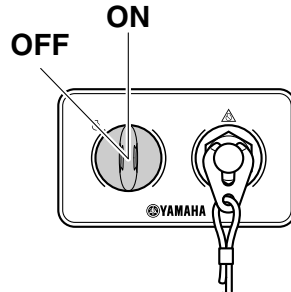

EMU42082

## Start/Stop switch panel

The engine can be started or turned off by pressing the Start/Stop button. For twin and triple type, it is possible to start or turn off individual engine. The indicator for the corresponding engine will come on.

- **PORT:** Port side engine
- **CENTER:** Center engine
- **STBD:** Starboard side engine

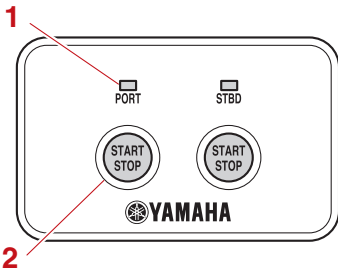

1. Indicator
2. Start/Stop button

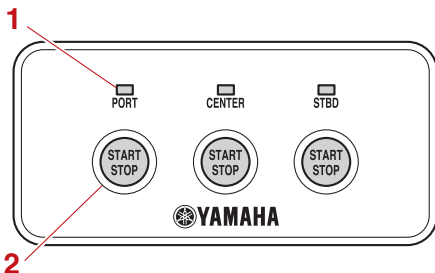

1. Indicator
2. Start/Stop button

EMU41633

## All Start/Stop switch panel (optional)

The Start/Stop button allows all engines to start or turn off.

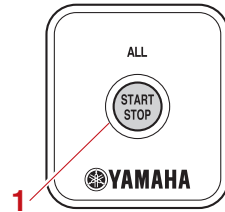

1. All Start/Stop button

EMU35775

## Engine shut-off cord (lanyard) and clip

The clip must be attached to the engine shut-off switch for the engine to run. The cord should be attached to a secure place on the operator's clothing, or arm or leg. Should the operator fall overboard or leave the helm, the cord will pull out the clip, stopping ignition to the engine. This will prevent the boat from running away under power.

EW001791

### **WARNING**

- **Attach the engine shut-off cord to a secure place on your clothing, or your arm or leg while operating.**
- **Do not attach the cord to clothing that could tear loose. Do not route the cord where it could become entangled, preventing it from functioning.**
- **Avoid accidentally pulling the cord during normal operation. Loss of engine power means the loss of most steering control. Also, without engine power, the boat could slow rapidly. This could cause people and objects in the boat to be thrown forward.**

### **TIP:**

The engine cannot be started with the clip removed.

# Components

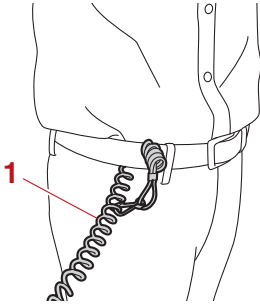

1. Engine shut-off cord (lanyard)

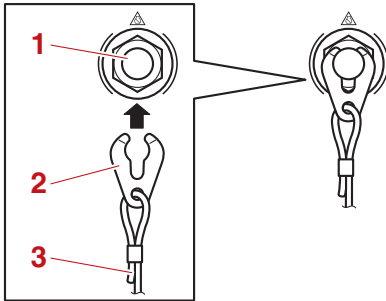

1. Engine shut-off switch
2. Clip
3. Engine shut-off cord (lanyard)

EMU48651

## Outboard motor equipment

EMU26156

### Power trim and tilt switch on bottom cowling

The power trim and tilt switch is located on the side of the bottom cowling. Pushing the switch “UP” (up) trims the outboard motor up, and then tilts it up. Pushing the switch “DN” (down) tilts the outboard motor down and trims it down. When the switch is released, the outboard motor will stop in its current position.

For instructions on using the power trim and tilt switch, see page 63.

EWM01032

### WARNING

Use the power trim and tilt switch located on the bottom cowling only when the boat is at a complete stop with the engine off. Attempting to use this switch while the boat is moving could increase the risk of falling overboard and could distract the operator, increasing the risk of collision with another boat or an obstacle.

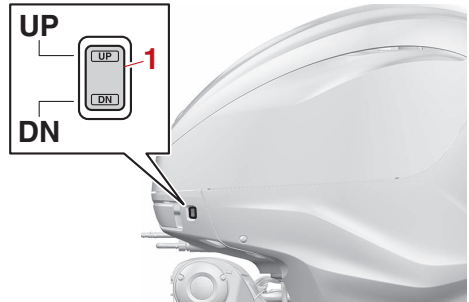

1. Power trim and tilt switch

EMU35041

### Tilt limiter

This outboard motor is equipped with a tilt limiter that controls the tilt range.

#### TIP:

Consult your Yamaha dealer about changing the setting.

EMU47780

### Tilt support lever for power trim and tilt model

To keep the outboard motor in the tilted up position, lock the tilt support lever to the clamp bracket. Make sure that the lever is securely held in place by the bolts.

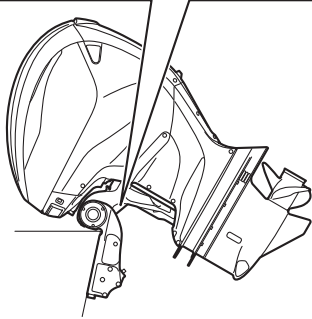
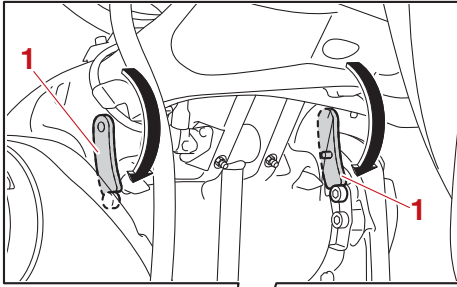

1. Tilt support lever

## TIP:

To use the lower tilted up position, remove the upper bolts.

ECM00661

## NOTICE

**Do not use the tilt support lever or knob when trailering the boat. The outboard motor could shake loose from the tilt support and fall. If the motor cannot be trailered in the normal running position, use an additional support device to secure it in the tilt position.**

EMU40762

## Cowling lock lever

The cowling lock levers are used to secure the top cowling.

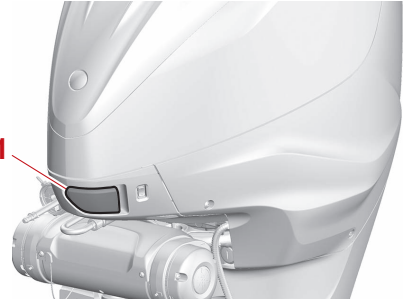

1. Cowling lock lever



1. Cowling lock lever

EMU40803

## Flushing device

The flushing device is used to clean the cooling water passages of the outboard motor using a garden hose and tap water. For instructions on using the flushing device, see page 69.



1. Flushing device

# Components

---

EMU41312

## Fuel filter

The fuel filter functions to remove foreign material and separate water from the fuel. If water separated from the fuel exceeds a specific volume, the alert system will activate. For further information, see page 38.

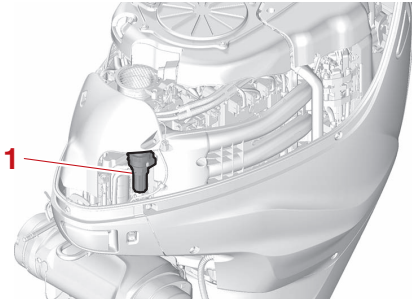

1. Fuel filter

# Instruments and indicators

EMU49441

## CL5 Display

The CL5 Display shows engine status and alert information. The display can be changed. This manual mainly covers the alert display.

If a warning message appears on the CL5 Display, follow the instructions on the display.

### TIP:

- The functions shown in the display varies according to the equipment of the boat.
- For more information, see the CL5 owner's manual.

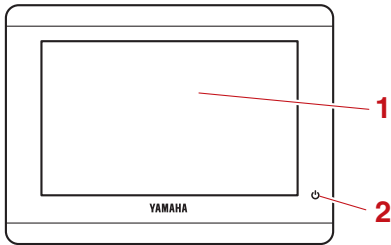

1. Touchscreen
2. Power button

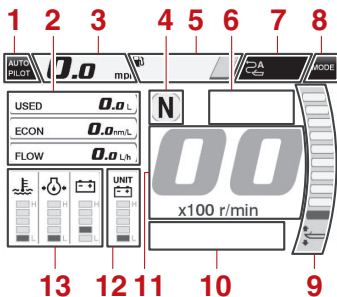

1. Autopilot button (Equipped with an Autopilot panel)
2. Boat status
3. Speedometer
4. Shift position
5. Tank level

6. Engine condition
7. Boat control indicator
8. Boat control mode button (Equipped with a Joystick)
9. Trim angle
10. Engine alert
11. Tachometer
12. Sub status
13. Engine status

### Engine condition icons

Orange icons indicate engine conditions.

#### ● Yamaha Security System indicator “” (optional)

This indicator appears when the Yamaha Security System is in lock mode. Make sure it is off before starting the engine.

### TIP:

This function is displayed when the 6X6 switch panel is equipped.

#### ● Engine warm-up indicator “”

This indicator appears while the engine is being warmed up and goes off when warming-up is finished.

#### ● Engine synchronization indicator “”

In multiple engine types, this indicator appears while the engines are under synchronization control. It goes off when engine synchronization control is released.

### Engine alert icons

Red icons indicate engine abnormalities. When an abnormality occurs, a pop-up window will be displayed, and the buzzer will sound.

# Instruments and indicators

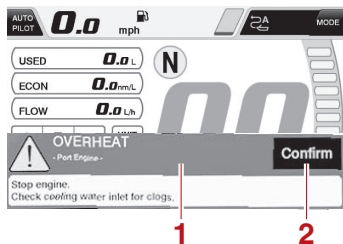

1. Pop-up window
2. Confirm button

Press the confirm button to change to the normal display. The engine alert icon will start to blink.

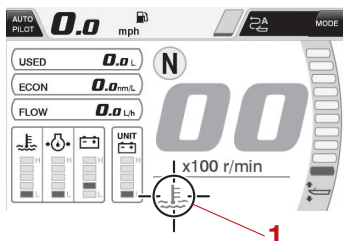

1. Engine alert icon

ECM00093

## NOTICE

**Do not continue to operate the engine if an alert device has activated. Consult your Yamaha dealer if the problem cannot be located and corrected.**

The engine alert icon will appear according to the kind of abnormality. The symbols and their explanations are described below.

### ● Overheat alert “”

If the engine temperature rises too high while cruising, this alert will be activated. Stop the engine immediately. Check the cooling water inlet for clogging, and clear it if it is blocked.

ECM01594

## NOTICE

- Do not continue to run the engine if the overheat-alert indicator blinks. Serious engine damage will occur.
- Do not continue to operate the engine if an alert device has activated. Consult your Yamaha dealer if the problem cannot be located and corrected.

### ● Low oil pressure alert “”

If the engine oil pressure drops too low, this alert will be activated. Stop the engine immediately. Check the engine oil level and replenish oil if necessary. If the alert device has activated while the appropriate engine oil level is maintained, consult your Yamaha dealer.

ECM01602

## NOTICE

**Do not continue to run the engine if the low oil pressure alert device has activated. Serious engine damage will occur.**

### ● Water in Fuel Alert “”

If water has accumulated in the water separator (fuel filter) while cruising, this alert will be activated. Stop the engine immediately and see page 90 of this manual to drain the water from the fuel filter. Consult a Yamaha dealer.

ECM00911

## NOTICE

**Gasoline mixed with water could cause damage to the engine.**

### ● Low battery voltage alert “”

If the battery voltage drops, this alert will be activated. If the low battery voltage alert device has activated, return to port and consult a Yamaha dealer immediately. To charge the battery, consult your Yamaha dealer.



- **Check engine alert** “”

If the engine malfunctions while cruising, this alert will be activated. Return to port and consult a Yamaha dealer immediately.

- **Check System / Steering Malfunction Alert** “”

If a malfunction occurs in the system, the system alert will be activated. Return to port immediately and contact your Yamaha dealer.

# Engine control system

EMU26806

## Alert system

ECM00093

### NOTICE

**Do not continue to operate the engine if an alert device has activated. Consult your Yamaha dealer if the problem cannot be located and corrected.**

EMU47362

### Helm Master control system alert

The Helm Master control system alert information is displayed on the display installed in the boat. For further information, see the owner's manual.

EMU35188

### Digital electronic control alert

If during operation of the outboard motor any communication troubles between the digital electronic control and the outboard motor occur, the DEC alert indicator will change from blue to orange. Even if there is no symptom of trouble with shifting or throttle, get back to port soon and have a Yamaha dealer inspect or repair the outboard motor.

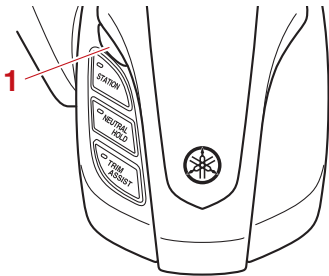

1. DEC alert indicator

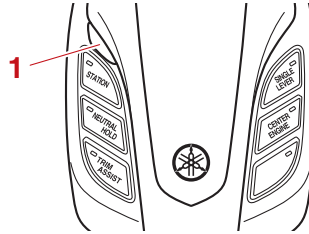

1. DEC alert indicator

EMU47384

### Overheat alert

This outboard motor has an overheat alert system. If the engine temperature rises too high, the alert system will activate.

- The engine speed will automatically decrease to about 2000–3500 r/min.
- The overheat-alert indicator will come on or blink.
- The pop-up window will appear on the Multi-Display.



- The buzzer will sound. (The device that produces the sound may be different depending on the equipment installed on the boat.)

# Engine control system

**Illustration showing an example of the possible buzzer location**

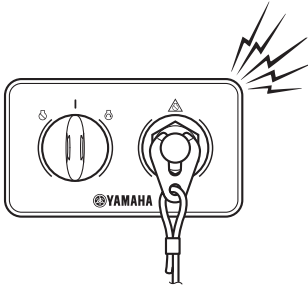

If the alert system has activated, stop the engine and check the cooling water inlets.

- Check the trim angle to be sure that the cooling water inlets are submerged.

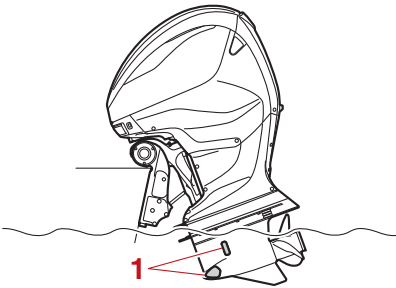

1. Cooling water inlet

- Check the cooling water inlets for clogging.

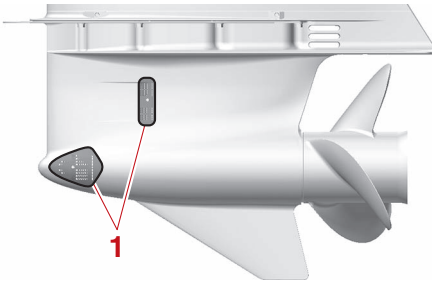

1. Cooling water inlet

## Multiple-engine users

If the overheat alert system of one outboard motor activates, the engine will slow down.

To turn off the alert activation on the outboard motors not affected by overheating

- (1) Stop the overheated engine.

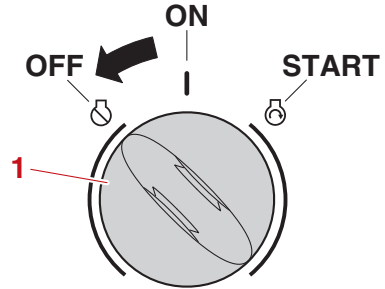

1. Main switch

## TIP:

If the alert system has activated, stop the engine and tilt the outboard motor up to check the cooling water inlets for clogging.

- (2) If the alert system is still activated, tilt the overheated outboard motor up and return to port.

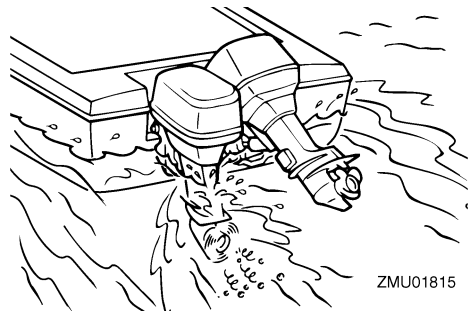

ZMU01815

EMU47395

## Low oil pressure alert

If the oil pressure drops too low, the alert system will activate.

- The engine speed will automatically decrease to about 2000–3500 r/min.
- The low oil pressure-alert indicator will come on or blink.
- The pop-up window will appear on the Multi-Display.

# Engine control system



- The buzzer will sound. (The device that produces the sound may be different depending on the equipment installed on the boat.)

**Illustration showing an example of the possible buzzer location**

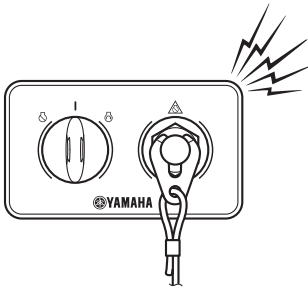

## TIP:

If the alert system has activated, stop the engine as soon as it is safe to do so. Check the oil level and add oil as needed. If the oil level is correct and the alert system does not turn off, consult your Yamaha dealer.

## Multiple-engine users

If the low oil pressure alert system of one outboard motor activates, all of the engines will slow down and the buzzer will sound.

To turn off the alert activation on the outboard motors not affected by the low oil pressure

Stop the engine that has the low oil pressure.

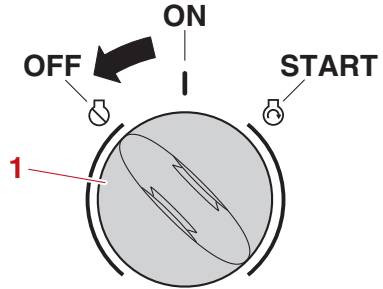

1. Main switch

EMU47403

## Water separator alert

The outboard motor is equipped with a water separator alert system. If water separated from the fuel exceeds a specific volume, the alert system will activate.

- The water separator-alert indicator will come on or blink.
- The pop-up window will appear on the Multi-Display.



- The buzzer will sound intermittently when the control lever is in the neutral position.

If the alert system has activated

Stop the engine and see page 93 of this manual to drain the water from the fuel filter. Return to port and consult a Yamaha dealer immediately.

ECM02471

## **NOTICE**

---

**Although the buzzer will stop when the engine is started and the control lever is moved to the forward or reverse position, do not use the outboard motor. Otherwise, serious engine damage could occur.**

---

# Installation

EMU26903

## Installation

The information presented in this section is intended as reference only. It is not possible to provide complete instructions for every possible boat and motor combination. Proper mounting depends in part on experience and the specific boat and motor combination.

EWM01591

### **WARNING**

- **Overpowering a boat could cause severe instability. Do not install an outboard motor with more horsepower than the maximum rating on the capacity plate of the boat. If the boat does not have a capacity plate, consult the boat manufacturer.**
- **Improper mounting of the outboard motor could result in hazardous conditions such as poor handling, loss of control, or fire hazards. For permanently mounted models, your dealer or other person experienced in proper rigging should mount the motor.**

EMU35812

### **Mounting the outboard motor**

The outboard motor should be mounted so that the boat is well balanced. Otherwise, the boat could be hard to steer. For single-engine boats, mount the outboard motor on the centerline (keel line) of the boat.

For twin engine boats, mount the outboard motors equidistant from the centerline.

For triple engine boats, mount the center outboard motor on the centerline (keel line), and the port side and starboard side outboard motors equidistant from the center outboard motor.

Consult your Yamaha dealer or boat manufacturer for further information on determining the proper mounting location.

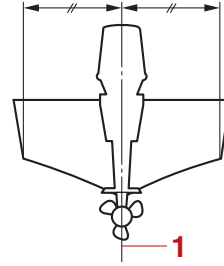

1. Center line (keel line)

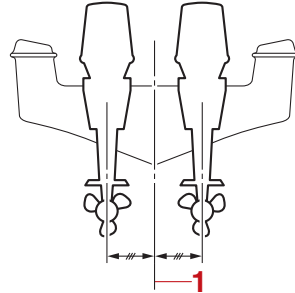

1. Center line (keel line)

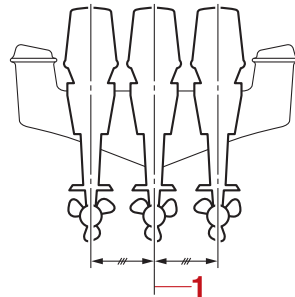

1. Center line (keel line)

EMU26937

### **Mounting height (boat bottom)**

The mounting height of your outboard motor affects its efficiency and reliability. If it is mounted too high, propeller ventilation may occur, which will reduce propulsion due to excessive propeller slip, and the water intakes for the cooling system may not get an adequate water supply, which can cause en-

engine overheating. If the engine is mounted too low, water resistance (drag) will increase, thereby reducing engine efficiency and performance.

Most commonly, an outboard motor should be mounted so that the anti-cavitation plate is in alignment with the bottom of the boat. The optimum mounting height of the outboard motor is affected by the boat/motor combination and the desired use. Test runs at different heights can help determine the optimum mounting height. Consult your Yamaha dealer or boat manufacturer for further information on determining the proper mounting height.

**enter the engine through the air intake opening in the top cowling to cause severe engine damage. Remove the cause of the airborne water spray.**

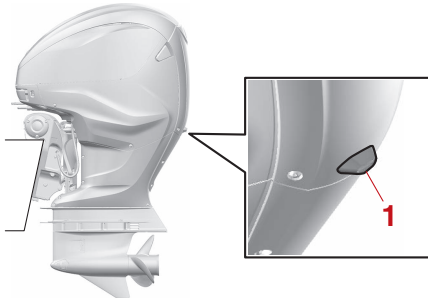

1. Idle hole

ECM01635

## NOTICE

- **Make sure that the idle hole is high enough to prevent water from entering the engine even if the boat is stationary with the maximum load.**
- **Incorrect engine height or obstructions to the smooth flow of water (such as the design or condition of the boat, or accessories, such as transom ladders or depth finder transducers) can create airborne water spray while the boat is cruising. If the outboard motor is operated continuously in the presence of airborne water spray, enough water could**

# Operation

EMU36382

## First-time operation

EMU40512

### Filling engine oil

The outboard motor is shipped from the factory without engine oil. If your Yamaha dealer did not fill the engine with engine oil, you must fill the engine before starting it. **NOTICE: Make sure that the engine is filled with engine oil before operating the outboard motor for the first time. Otherwise, the engine could be damaged severely.**

[ECM02241]

The following tag, which is fitted on the outboard motor when it is shipped from the factory, should be removed after the engine is filled with engine oil for the first time. For more information on checking the engine oil level, see page 45.



EMU30175

### Breaking in engine

Your new engine requires a period of break-in to allow mating surfaces of moving parts to wear in evenly. Correct break-in will help ensure proper performance and longer engine life. **NOTICE: Failure to follow the break-in procedure could result in reduced engine life or even severe engine damage.** [ECM00802]

EMU41223

### Procedure for breaking in engine

Your new engine requires a period of 10 hours break-in so that mating surfaces of moving parts wear in evenly.

Operate the engine in the water under load (in gear with a propeller installed) for 10 hours as follows. When breaking in the engine, avoid extended idling, rough water, and crowded areas.

- (1) For the 1st hour of operation:  
Operate the engine at varying speeds up to 2000 r/min or approximately 1/2 throttle.
- (2) For the 2nd hour of operation:  
Increase the engine speed until the boat is on plane (but avoid full-throttle operation), and then back off on the throttle while keeping the boat at a planing speed.
- (3) For the remaining 8 hours of operation:  
Operate the engine at any speed. However, avoid operating at full throttle for more than 5 minutes at a time.
- (4) After the 1st 10 hours of operation:  
Operate the engine normally.

EMU36402

### Getting to know your boat

All boats have unique handling characteristics. Operate cautiously while you learn how your boat handles under different conditions and various trim angles (see page 61).



EMU36414

## Checks before starting engine

EWM01922

### **WARNING**

If any item in “Checks before starting engine” is not working properly, have it inspected and repaired before operating the outboard motor. Otherwise, an accident could occur.

ECM00121

### **NOTICE**

Do not start the engine out of water. Overheating and serious engine damage can occur.

EMU36422

## Fuel level

Be sure you have plenty of fuel for your trip. A good rule is to use 1/3 of your fuel to get to the destination, 1/3 to return, and to keep 1/3 as an emergency reserve. With the boat level on a trailer or in the water, turn the key to “ON” (on) and check the fuel level. For fuel filling instructions, see page 48.

EMU47580

## Removing top cowling

For the following checks in this chapter, remove the top cowling.

To remove the top cowling

- (1) Pull the cowling lock levers outward, and then turn them upward.

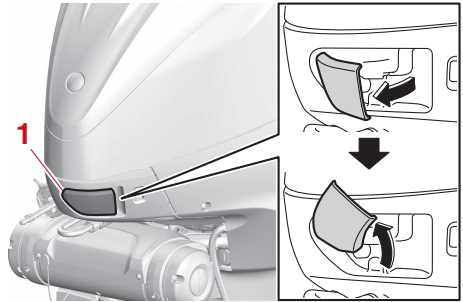

1. Cowling lock lever

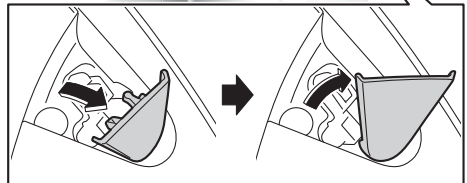
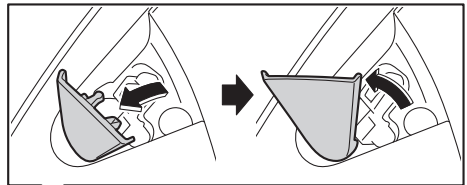

1. Cowling lock lever

- (2) Lift up the top cowling.

# Operation

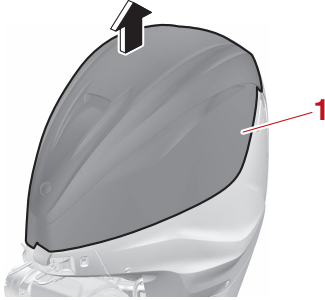

1. Top cowling

EMU36443

## Fuel system

EWM00061



**Gasoline and its vapors are highly flammable and explosive. Keep away from sparks, cigarettes, flames, or other sources of ignition.**

EWM00911



**Leaking fuel can result in fire or explosion.**

- Check for fuel leakage regularly.
- If any fuel leakage is found, the fuel system must be repaired by a qualified mechanic. Improper repairs can make the outboard unsafe to operate.

EMU36453

## Check for fuel leaks

- Check for fuel leaks or gasoline fumes in the boat.
- Check for fuel leakage from the fuel system.
- Check the fuel tank and fuel lines for cracks, swellings, or other damage.

EMU37323

## Checking the fuel filter

Check that the fuel filter is clean and free of water. If any water is found in the fuel, or if a significant amount of debris is found, the fuel tank should be checked and cleaned by a Yamaha dealer.

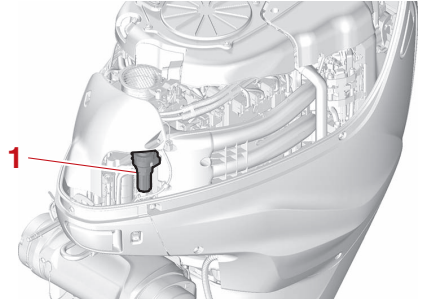

1. Fuel filter

EMU47813

## Controls

- (1) Make sure that when the main switch is turned “ON” (on) or the “POWER” switch is pressed, the DEC alert indicator will come on in blue.

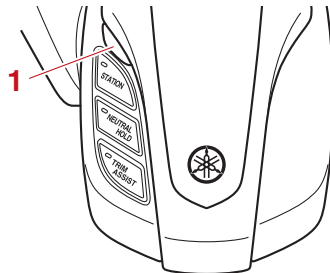

1. DEC alert indicator

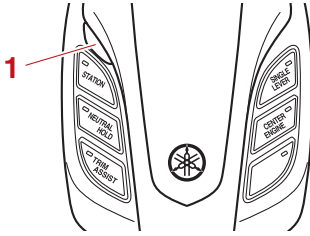

1. DEC alert indicator

- (2) Turn the steering wheel fully to the left and right and make sure that the outboard motor moves to port and starboard smoothly.
- (3) Operate the remote control levers several times to make sure there is no hesitation in their travel.

EMU40363

## Engine shut-off cord (lanyard)

Check the engine shut-off cord and clip for damage, such as cuts, breaks, and wear.

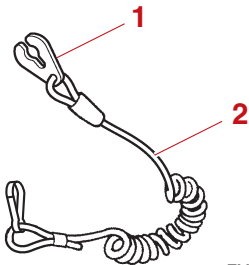

ZMU06873

1. Clip
2. Engine shut-off cord (lanyard)

EMU40994

## Engine oil

- (1) Place the outboard motor in a vertical position (not tilted). **NOTICE: If the outboard motor is not level, the oil level indicated on the oil dipstick may not be accurate.** [ECM01862]

- (2) Remove the oil dipstick and wipe it clean.

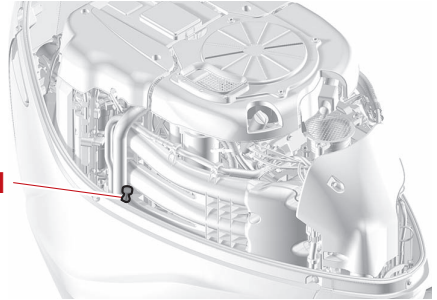

1. Oil dipstick

- (3) Insert the oil dipstick completely and remove it again.
- (4) Check that the oil level on the oil dipstick is between the upper and lower marks. Consult your Yamaha dealer if the oil level is not at the proper level or if it appears milky or dirty.

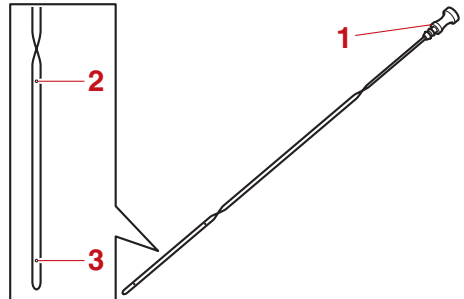

1. Oil dipstick
2. Upper mark
3. Lower mark

EMU40412

## Outboard motor

- Check that the outboard motor is mounted properly and check the outboard motor mounting bolts for looseness.
- Check the propeller for damage.
- Check for engine oil leaks.

# Operation

EMU36494

## Flushing device

Check that the flushing device's garden hose connector is securely screwed on to the fitting on the bottom cowling. **NOTICE: If the garden hose connector is not properly connected, cooling water can leak out and the engine can overheat during operation.**

[ECM01802]

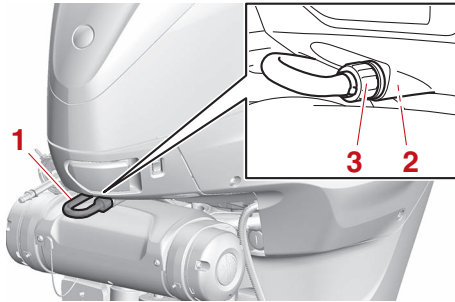

1. Flushing device
2. Fitting
3. Garden hose connector

EMU47570

## Installing top cowling

- (1) Check the rubber seal for damage. If the rubber seal is damaged, have it replaced by a Yamaha dealer.

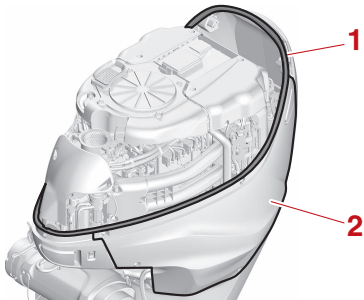

1. Rubber seal
2. Apron

- (2) Check that the rubber seal is seated all the way around the aprons.

- (3) Check that all of the cowling lock levers are pulled outward and turned upward.
- (4) Place the top cowling on the aprons.

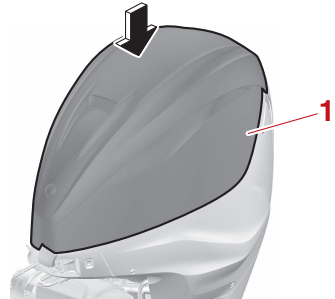

1. Top cowling

- (5) Turn the cowling lock levers downward, and then push them inward to secure the top cowling.

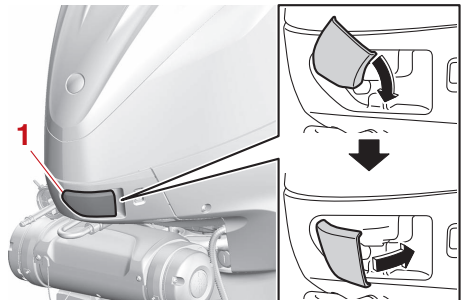

1. Cowling lock lever

EMU35245

## Checking power trim and tilt system

EWM01931

### **WARNING**

- Never get under the lower unit while it is tilted, even when the tilt support lever is locked. Severe injury could occur if the outboard motor accidentally falls.
- Body parts can be crushed between the motor and the clamp bracket when the motor is trimmed or tilted.
- Be sure no one is near the outboard motor before performing this check.

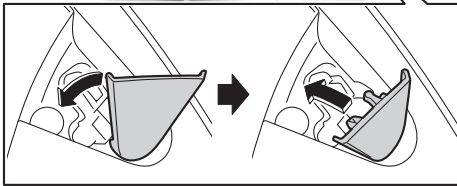
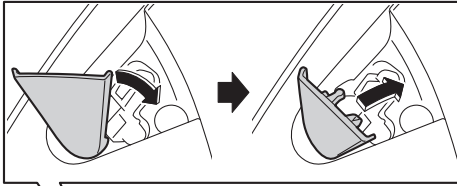

1. Cowling lock lever

- (6) Check the fitting of the top cowling by pushing it with both hands. **NOTICE: If the top cowling is not installed correctly, water can enter the top cowling and damage the engine, or the top cowling can blow off at high speeds.**

[ECM02371]



- (1) Check the power trim and tilt unit for any sign of oil leaks.
- (2) Operate each of the power trim and tilt switches on the digital electronic control and engine bottom cowling (if equipped) to check that all switches work.
- (3) Tilt the outboard motor up and check that the tilt rod and trim rods are extended completely.

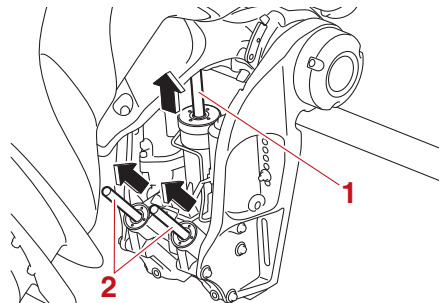

1. Tilt rod
2. Trim rod

- (4) Use the tilt support lever to lock the motor in the up position. Operate the tilt down switch briefly so the motor is supported by the tilt support lever.

# Operation

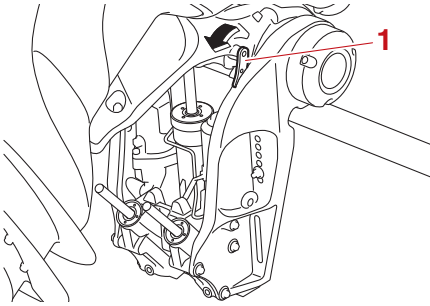

1. Tilt support lever

- (5) Check that the tilt rod and trim rods are free of corrosion or other flaws.
- (6) Activate the tilt-down switch until the trim rods have retracted completely into the cylinders.

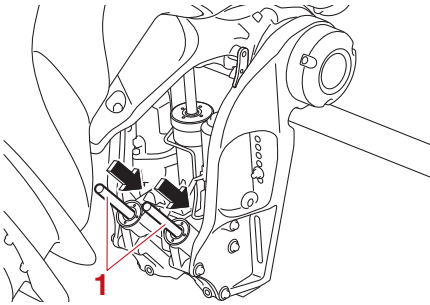

1. Trim rod

- (7) Activate the trim-up switch until the tilt rod is fully extended. Unlock the tilt support lever.

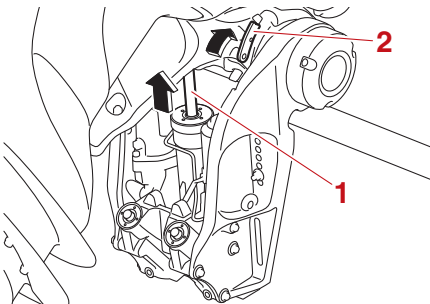

1. Tilt rod  
2. Tilt support lever

- (8) Tilt the outboard motor down. Check that the tilt rod and trim rods operate smoothly.

EMU36585

## Battery

Check the battery's charge. If your boat is equipped with a Yamaha digital speedometer, the voltmeter and low battery alert functions will help you monitor the battery's charge. A battery in good condition will provide a minimum of 12 volts. Check that the battery connections are clean, secure and covered by insulating covers. The electrical connections of the battery and cables must be clean and properly connected or the battery will not start the engine.

If the battery needs charging, consult your Yamaha dealer or the battery manufacturer's instructions.

EMU47643

## Filling fuel

EWM01831

### **WARNING**

- Gasoline and its vapors are highly flammable and explosive. Always refuel according to this procedure to reduce the risk of fire and explosion.
- Gasoline is poisonous and can cause injury or death. Handle gasoline with care. Never siphon gasoline by mouth. If you should swallow some gasoline or inhale a lot of gasoline vapor, or get some gasoline in your eyes, see your doctor immediately. If gasoline spills on your skin, wash with soap and water. If gasoline spills on your clothing, change your clothes.

ECM05272

## NOTICE

**Check the amount of remaining fuel regularly. Running out of fuel can damage the engine.**

Before refueling, check the following points:

- Ensure the engine is stopped.
- Securely moor the boat in a well-ventilated area and stop the engine. If the boat is trailered, make sure that it is stable.
- Make sure that no one is in the boat.
- Do not smoke and keep away from sparks, flames, static electric discharge, or other sources of ignition.
- If you use a portable container to store and dispense fuel, only use a locally approved GASOLINE container.
- To prevent electrostatic sparks, discharge any built-up static electricity from your body before refueling.

- (1) Remove the fuel tank cap.
- (2) Fill the fuel tank with fuel. **WARNING! Do not overfill. Otherwise fuel can expand and overflow if the temperature increases.** [EWM02611]
- (3) Tighten the fuel tank cap securely.
- (4) Wipe up any spilled gasoline immediately with dry rags. Dispose of rags properly according to local laws or regulations.

EMU40252

## Operating engine

EWM02601

### **WARNING**

**This product emits exhaust gases which contain carbon monoxide, a colorless, odorless gas which could cause brain damage or death when inhaled. Symptoms include nausea, dizziness, and drowsiness. Keep cockpit and cabin areas well ventilated. Avoid blocking exhaust outlets.**

EMU31814

## Sending fuel

- (1) If there is a fuel joint or a fuel valve on the boat, firmly connect the fuel line to the joint or open the fuel valve.
- (2) Squeeze the primer pump, with the arrow pointing up, until you feel it become firm.

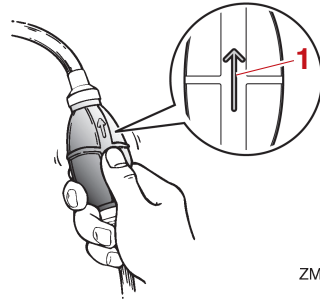

ZMU02025

1. Arrow

EMU27496

## Starting engine

EWM01601

### **WARNING**

**Before starting the engine, make sure that the boat is tightly moored and that you can steer clear of any obstructions. Be sure there are no swimmers in the water near you.**

EMU41792

## Start-up checks

Place the control lever in neutral and turn the main switch to “ON” (on) or turn the “POWER” switch on. If the buzzer sounds and the water separator-alert indicator blinks, consult a Yamaha dealer immediately.

EMU48763

## Procedure for single station models (6X6 switch)

EWM01842

### **WARNING**

- Failure to attach the engine shut-off cord could result in a runaway boat if operator is ejected. Attach the engine

# Operation

shut-off cord to a secure place on your clothing, or your arm or leg while operating. Do not attach the cord to clothing that could tear loose. Do not route the cord where it could become entangled, preventing it from functioning.

- Avoid accidentally pulling the cord during normal operation. Loss of engine power means the loss of most steering control. Also, without engine power, the boat could slow rapidly. This could cause people and objects in the boat to be thrown forward.

- (1) Place the control lever in “N” (neutral).

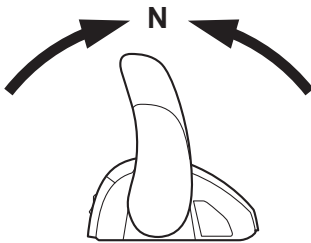

## TIP:

The start-in-gear protection device prevents the engine from starting except when in neutral.

- (2) Attach the engine shut-off cord to a secure place on your clothing, or your arm or leg. Then install the clip on the other end of the cord into the engine shut-off switch.

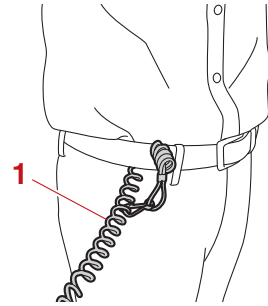

1. Engine shut-off cord (lanyard)

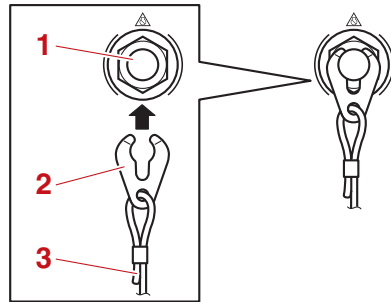

1. Engine shut-off switch  
2. Clip  
3. Engine shut-off cord (lanyard)

- (3) Turn the main switch to “ON” (on) and make sure that the DEC alert indicator comes on in blue. The engine cannot be started if the DEC alert indicator comes on in orange.

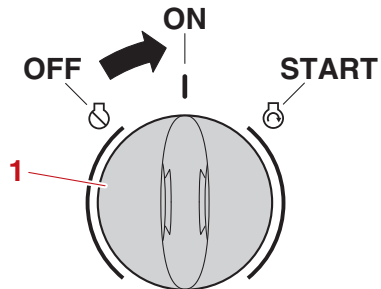

1. Main switch



- (4) Turn the main switch to “START” (start), and hold it for a maximum of 5 seconds. **NOTICE: Never turn the main switch to “START” (start) while the engine is running. Do not keep the starter motor turning for more than 5 seconds. If the starter motor is turned continuously for more than 5 seconds, the battery will be quickly discharged, thus making it impossible to start the engine. The starter can also be damaged. If the engine will not start after 5 seconds of cranking, return the main switch to “ON” (on), wait 10 seconds, then crank the engine again.** [ECM00193]

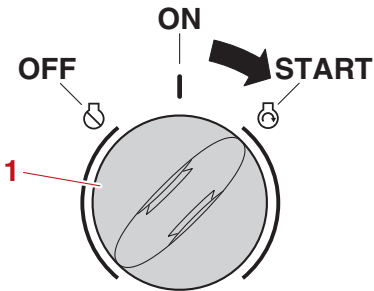

## 1. Main switch

When starting the engine using the Start/Stop button, press the button to start the engine. The indicator for the starting engine will come on.

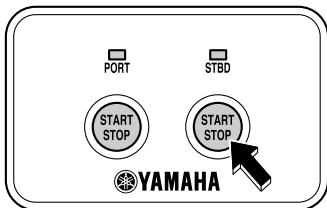

ZMU07148

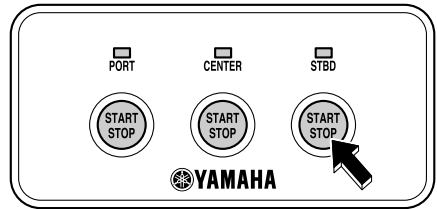

ZMU07149

When starting the engine using the All Start/Stop button on the All Start/Stop panel, press the button to start the all engines.



ZMU07150

## TIP:

- When the main switch is turned to “START” (start) with the clip removed from the engine shut-off switch, the buzzer will sound.
- Except the single type, if the clip is not installed to the engine shut-off switch, the buzzer will sound when the Start/Stop button is pressed.
- Except the single type, if one of the engines has started, it can be stopped by pressing the Start/Stop button on the All start/Stop panel.

EMU48772

## Procedure for dual station models (main station/6X6 switch)

- (1) Place the control lever in “N” (neutral).

# Operation

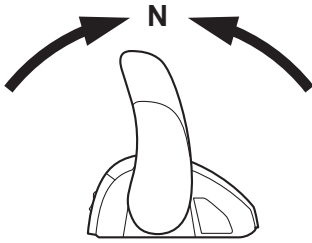

## TIP:

The start-in-gear protection device prevents the engine from starting except when in neutral.

- (2) Turn the main switch to “ON” (on) and make sure that the DEC alert indicator comes on in blue. The engine cannot be started if the DEC alert indicator comes on in orange.

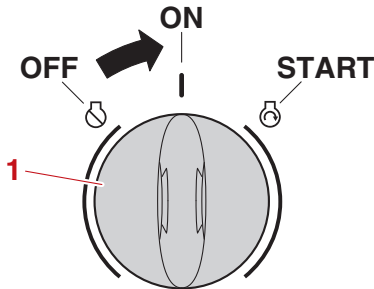

1. Main switch

- (3) Push the “STATION” switch. Station change is only possible when all control levers have been set to “N” (neutral). Make sure that the DEC alert indicator comes on in blue.

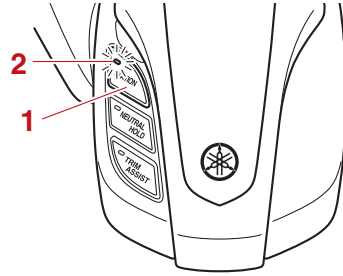

1. “STATION” switch
2. LED

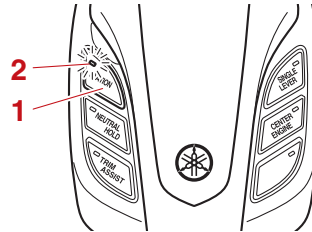

1. “STATION” switch
2. LED

- (4) The procedure until starting the engine is the same as that of the single station models. **NOTICE: Never turn the main switch to “START” (start) while the engine is running. Do not keep the starter motor turning for more than 5 seconds. If the starter motor is turned continuously for more than 5 seconds, the battery will be quickly discharged, thus making it impossible to start the engine. The starter can also be damaged. If the engine will not start after 5 seconds of cranking, return the main switch to “ON” (on), wait 10 seconds, then crank the engine again.** [ECM00193]

## TIP:

The sub station can start and stop the engine. However, it cannot operate the digital electronic control.

EMU48782

## Procedure for dual station models (sub station/6X6 switch)

EWM01842

### **WARNING**

- **Failure to attach the engine shut-off cord could result in a runaway boat if operator is ejected. Attach the engine shut-off cord to a secure place on your clothing, or your arm or leg while operating. Do not attach the cord to clothing that could tear loose. Do not route the cord where it could become entangled, preventing it from functioning.**
- **Avoid accidentally pulling the cord during normal operation. Loss of engine power means the loss of most steering control. Also, without engine power, the boat could slow rapidly. This could cause people and objects in the boat to be thrown forward.**

- (1) Turn the main switch of the main station to “ON” (on) and make sure that the DEC alert indicator comes on in blue. The engine cannot be started if the DEC alert indicator comes on in orange.
- (2) Place the control lever in “N” (neutral).
- (3) Push the “STATION” switch of the sub station. Station change is only possible when all control levers have been set to “N” (neutral). Make sure that the DEC alert indicator of the sub station comes on in blue.

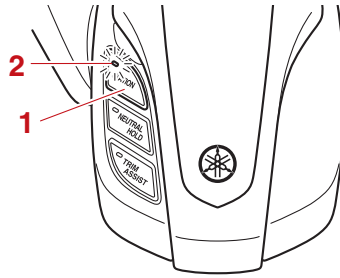

1. “STATION” switch
2. LED

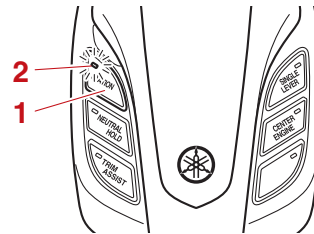

1. “STATION” switch
2. LED

## TIP:

The main station can still start and stop the engine. However, it cannot operate the digital electronic control.

- (4) Attach the engine shut-off cord to a secure place on your clothing, or your arm or leg. Then install the clip on the other end of the cord into the engine shut-off switch.

# Operation

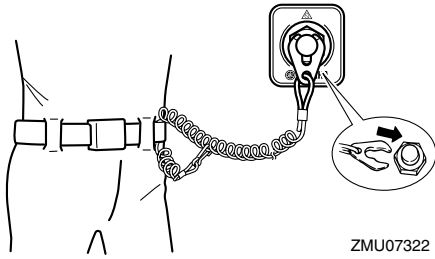

- (5) Press the Start/Stop button to start the engine. The indicator for the starting engine will come on. **NOTICE: Do not keep the starter motor turning for more than 5 seconds. If the starter motor is turned continuously for more than 5 seconds, the battery will be quickly discharged, thus making it impossible to start the engine. The starter can also be damaged. If the engine will not start after 5 seconds of cranking, release the Start/Stop button, wait 10 seconds, then crank the engine again.**

[ECM02491]

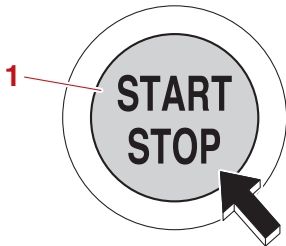

1. Start/Stop button

## TIP:

If the clip is not installed to the engine shut-off switch, the buzzer will sound when the Start/Stop button is pressed.

EMU36511

## Checks after starting engine

EMU41361

### Cooling water

Check for a steady flow of water from the cooling water pilot hole. A continuous flow of water from the cooling water pilot hole shows that the water pump is pumping water through the cooling water passages.

### TIP:

When the engine is started, there may be a slight delay before water flows from the cooling water pilot hole.

ECM02251

### NOTICE

If water is not flowing out of the cooling water pilot hole at all times while the engine is running, overheating and serious damage could occur. Stop the engine and check whether the cooling water inlet on the lower case or the cooling water pilot hole is blocked. Consult your Yamaha dealer if the problem cannot be located and corrected.

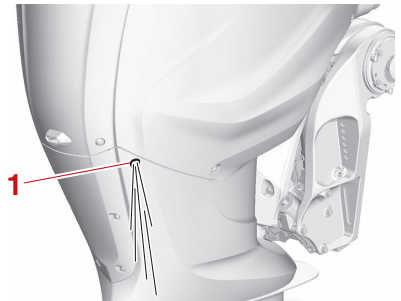

1. Cooling water pilot hole

EMU27671

## Warming up engine

EMU47821

### Procedure for warming up engine

After the engine has started, warm up the engine until the engine speed settles at idling speed.

The engine warm-up indicator “” appears while the engine is being warmed up and goes off when warming-up is finished.

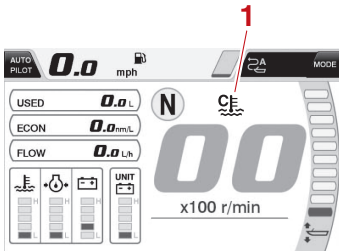

1. Engine warm-up indicator

EMU36532

## Checks after engine warm up

EMU36542

### Shifting

While the boat is tightly moored, and without applying throttle, confirm that the engine shifts smoothly into forward and reverse, and back to neutral.

EMU41821

### Stop switches

Perform the following procedure to check that the main switch and engine shut-off switch operate properly.

- Check that the engine stops when the main switch is turned to the “OFF” (off) position, or press the Start/Stop button.
- Check that the engine stops when the clip is pulled from the engine shut-off switch.

- Check that the engine cannot be started with the clip removed from the engine shut-off switch.

EMU35127

## Shifting

EWMO0181



**Before shifting, make sure there are no swimmers or obstacles in the water near you.**

Warm up the engine before shifting into gear. Until the engine is warm, the idle speed may be higher than normal. The control lever of the Digital electronic control can be operated even at high engine speeds. However, gear shifting will not work until the engine speed has automatically decreased to a speed at which actual gear shifting is possible. As a result, for quick gear shifting there could be a time lag when the gear is shifted until the engine speed has decreased sufficiently.

### To shift out of neutral

- (1) Pull the neutral interlock trigger up (if equipped).
- (2) Move the remote control lever to the forward position or reverse position  $22.5^\circ$  (a detent can be felt).

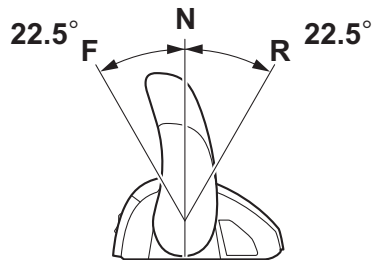

### To shift from in gear (forward/reverse) to neutral

- (1) Close the throttle so that the engine slows to idle speed.

# Operation

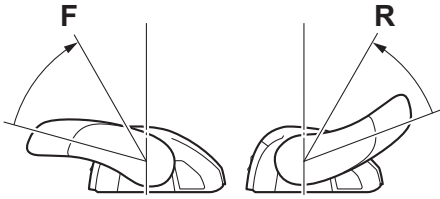

- (2) After the engine is at idle speed in gear, move the remote control lever to the neutral position.

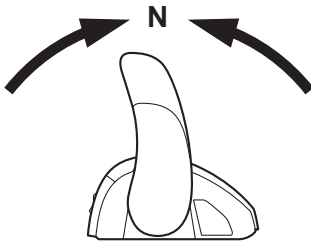

EMU48702

## Neutral hold switch operation

### To set

- (1) Place the control lever in “N” (neutral).
- (2) When the “NEUTRAL HOLD” switch is pressed, a beep will sound and the LED will come on.

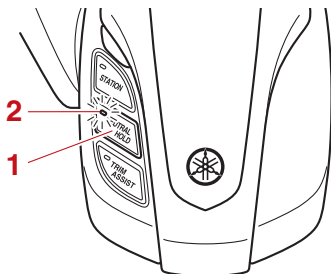

1. “NEUTRAL HOLD” switch

2. LED

- (3) You can open or close the throttle. This can also be done when the control lever is set in reverse.

### To release

- (1) Place the control lever in “N” (neutral).
- (2) When the “NEUTRAL HOLD” switch is pressed, a beep will sound and the LED will go off.
- (3) You can perform normal forward or reverse operation

EMU48711

## Center engine switch operation

### TIP:

- You cannot operate the starboard control lever when the single lever switch is activated.
- You must start all the engines to enable the center engine.

### To set

- (1) Place the control lever in “N” (neutral).
- (2) When the “CENTER ENGINE” switch is pressed, a beep will sound and the LED will come on.

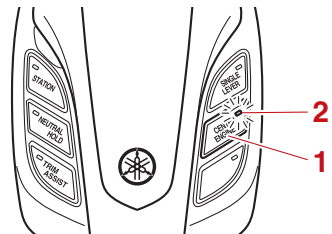

1. “CENTER ENGINE” switch (triple engines)
2. LED
- (3) You can operate the center engine by using the port side control lever.

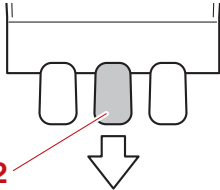
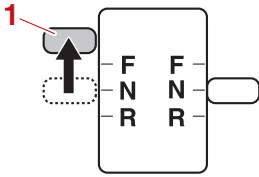

1. Port side control lever
2. Center engine

## To release

- (1) Place the control lever in “N” (neutral).
- (2) When the “CENTER ENGINE” switch is pressed, a beep will sound and the LED will go off.

EMU48720

## Single lever switch operation

### TIP:

- When the single lever switch is activated, the starboard control lever is inoperable. You must start all the engines to enable the single lever switch.

## To set

- (1) Place the control lever in “N” (neutral).
- (2) When the “SINGLE LEVER” switch is pressed, a beep will sound and the LED will come on.

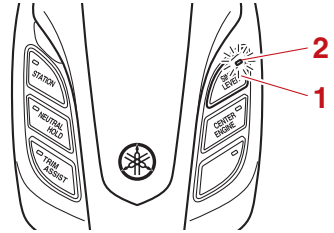

1. “SINGLE LEVER” switch
2. LED
- (3) The port side control lever will allow you to perform shift and throttle operations for all outboard motors that have been started.

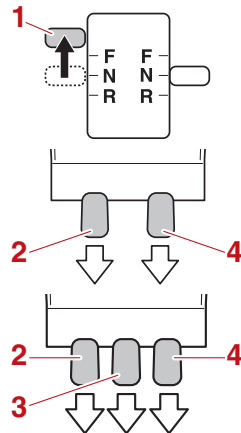

1. Port side control lever
2. Port side engine
3. Center engine
4. Starboard side engine

## To release

- (1) Place the control lever in “N” (neutral).
- (2) When the “SINGLE LEVER” switch is pressed, a beep will sound and the LED will go off.
- (3) You can perform normal shift or throttle operations.

# Operation

---

EMU31743

## Stopping boat

EWM01511



- **Do not use the reverse function to slow down or stop the boat as it could cause you to lose control, be ejected, or impact the steering wheel or other parts of the boat. This could increase the risk of serious injury. It could also damage the shift mechanism.**
  - **Do not shift into reverse while traveling at planing speeds. Loss of control, boat swamping, or damage to the boat could occur.**
- 

The boat is not equipped with a separate braking system. Water resistance stops it after the throttle lever is moved back to idle. The stopping distance varies depending on gross weight, water surface conditions, and wind direction.



EMU48731

## Boat direction

The illustrations below indicate the boat direction when operating multiple outboard motors.

### Lever operation (Twin engines)

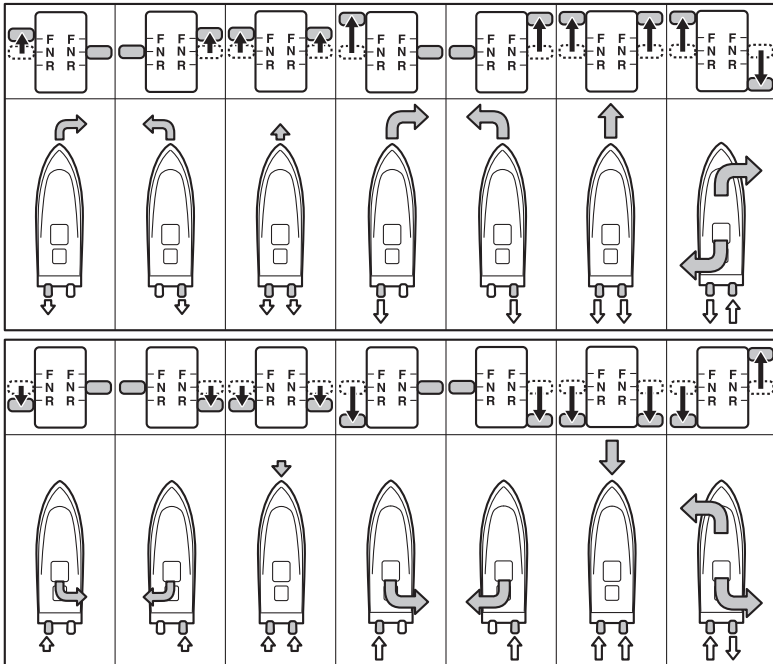

↕:Lever operation

↩:Boat direction and turning force

The size of the arrow is proportional to the turning force.

↔:Propulsion

# Operation

## Lever operation (Triple engines)

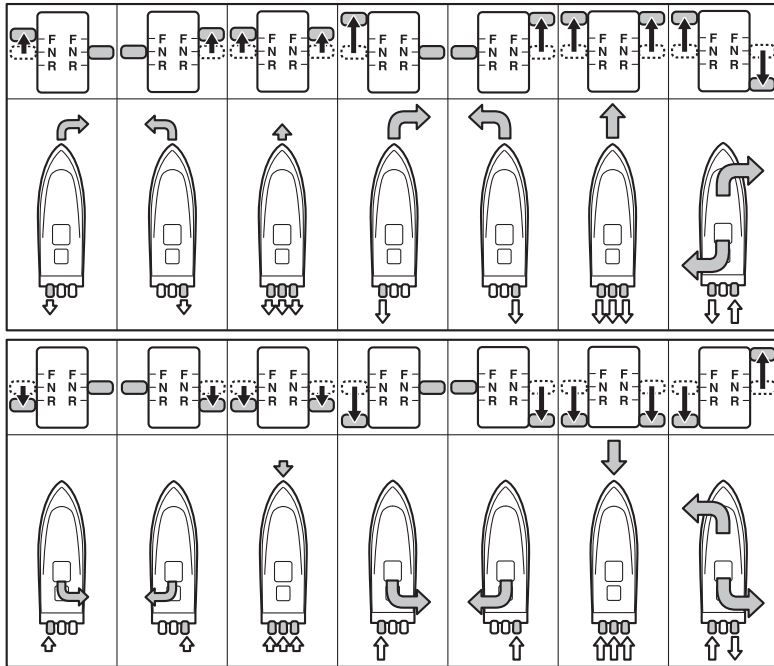

◀:Lever operation

↶:Boat direction and turning force

The size of the arrow is proportional to the turning force.

↔:Propulsion

EMU27823

## Stopping engine

Before stopping the engine, first let it cool off for a few minutes at idle or low speed. Stopping the engine immediately after operating at high speed is not recommended.

EMU42196

### Procedure for stopping engine (6X6 switch)

The engine can be turned off either by pressing the Start/Stop button or by turning the main switch to the "OFF" (off) position.

Situations when stopping engine from main station (dual-station models) or helm (single-station models)

- (1) Turn the main switch to "OFF" (off) or press the Start/Stop button until the engine stops completely.

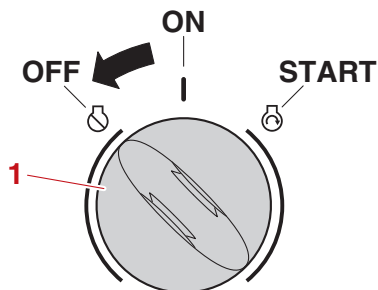

1. Main switch

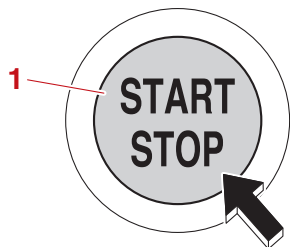

1. Start/Stop button

### TIP:

The engine can also be stopped by pulling the cord and removing the clip from the engine shut-off switch, then turning the main switch to "OFF" (off).

- (2) If the Start/Stop button was pressed to stop the engine in step (1), turn the main switch to "OFF" (off).
- (3) Remove the key if the boat will be left unattended.

Situations when stopping engine from sub station (dual-station models)

- (1) Press the Start/Stop button until the engine stops completely.

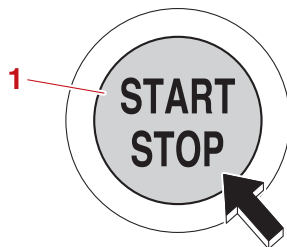

1. Start/Stop button
- (2) Turn the main switch to "OFF" (off) on the main station.

### TIP:

The engine can also be stopped by pulling the cord and removing the clip from the engine shut-off switch, then turning the main switch to "OFF" (off) on the main station.

- (3) Remove the key if the boat will be left unattended.

EMU27865

## Trimming outboard motor

EWM00741



**Excessive trim for the operating conditions (either trim up or trim down) can cause boat instability and can make steer-**

# Operation

ing the boat more difficult. This increases the possibility of an accident. If the boat begins to feel unstable or is hard to steer, slow down and/or readjust the trim angle.

The trim angle of the outboard motor helps determine the position of the bow of the boat in the water. Correct trim angle will help improve performance and fuel economy while reducing strain on the engine. Correct trim angle depends upon the combination of boat, engine, and propeller. Correct trim is also affected by variables such as the load in the boat, sea conditions, and running speed.

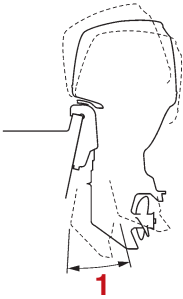

1. Trim operating angle

EMU27889

## Adjusting trim angle (Power trim and tilt)

EWM00754



- Be sure all people are clear of the outboard motor when adjusting the trim angle. Body parts can be crushed between the motor and the clamp bracket when the motor is trimmed or tilted.
- Use caution when trying a trim position for the first time. Increase speed gradually and watch for any signs of instability or control problems. Improper trim angle can cause loss of control.

- If equipped with a power trim and tilt switch located on the bottom cowling, use the switch only when the boat is at a complete stop with the engine off. Do not adjust the trim angle with this switch while the boat is moving.

Adjust the outboard motor trim angle using the power trim and tilt switch.

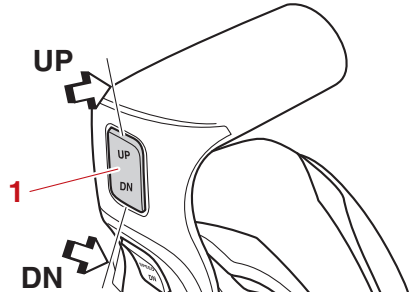

1. Power trim and tilt switch

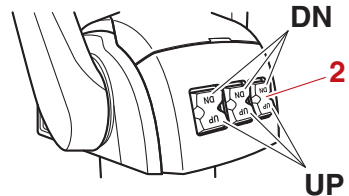
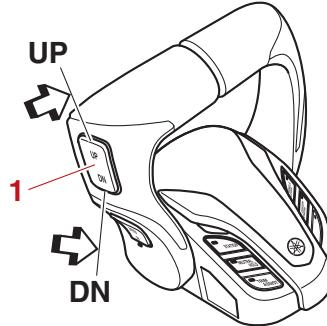

1. Power trim and tilt switch (all engines)
2. Power trim and tilt switch (individual engine)

To raise the bow (trim-out), press the switch “UP” (up).

To lower the bow (trim-in), press the switch “DN” (down).

Make test runs with the trim set to different angles to find the position that works best for your boat and operating conditions.

EMU27913

## Adjusting boat trim

When the boat is on plane, a bow-up attitude results in less drag, greater stability and efficiency. This is generally when the keel line of the boat is up about 3 to 5 degrees. With the bow up, the boat may have a greater tendency to steer to one side or the other. Compensate for this as you steer. When the bow of the boat is down, it is easier to accelerate from a standing start onto plane.

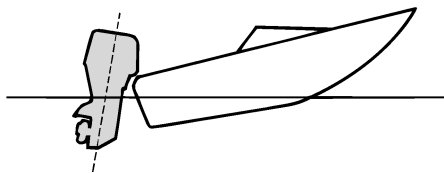

ZMU01785

## Bow Down

Too much trim-in causes the boat to “plow” through the water, decreasing fuel economy and making it hard to increase speed. Operating with excessive trim-in at higher speeds also makes the boat unstable. Resistance at the bow is greatly increased, heightening the danger of “bow steering” and making operation difficult and dangerous.

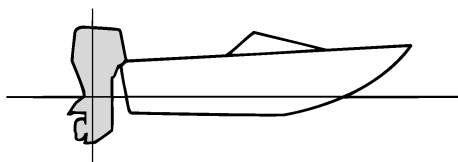

ZMU01784

## Bow Up

Too much trim-out puts the bow of the boat too high in the water. Performance and economy are decreased because the hull of the boat is pushing the water and there is more air drag. Excessive trim-out can also cause the propeller to ventilate, which reduces performance further, and the boat may “porpoise” (hop in the water), which could throw the operator and passengers overboard.

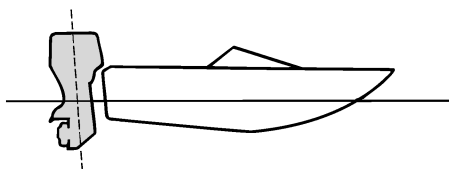

ZMU01786

## TIP:

Depending on the type of boat, the outboard motor trim angle may have little effect on the trim of the boat when operating.

EMU27948

## Tilting up and down

If the engine will be stopped for some time or if the boat is moored in shallows, the outboard motor should be tilted up to protect the propeller and lower case from damage by collision with obstructions, and also to reduce salt corrosion.

# Operation

EWM01544

## WARNING

Make sure that all people are clear of the outboard motor when tilting the outboard motor up and down. Body parts can be crushed between the outboard motor and the clamp bracket when the outboard motor is trimmed or tilted.

ECM00993

## NOTICE

- Before tilting the outboard motor, follow the procedure under “Stopping engine” in this chapter. Never tilt the outboard motor while the engine is running. Severe damage from overheating can result.
- To prevent the cooling water passages from becoming frozen when the ambient temperature is 5°C (41°F) or below, tilt the outboard motor up after it has been stopped 30 seconds or more.

EMU49330

## Procedure for tilting up (power trim and tilt models)

- (1) Place the remote control lever in neutral.

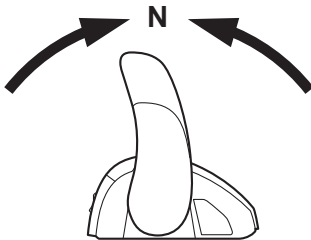

- (2) Press the power trim and tilt switch “UP” (up) until the outboard motor has tilted up completely.

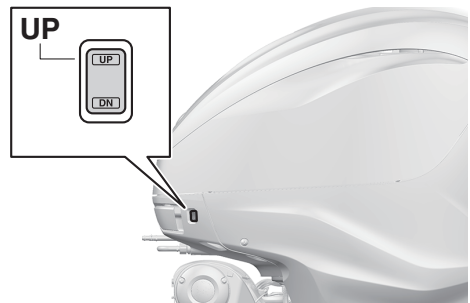
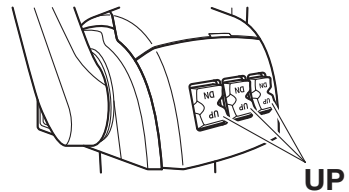
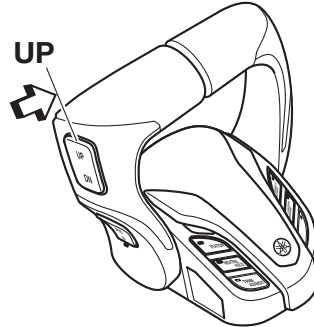
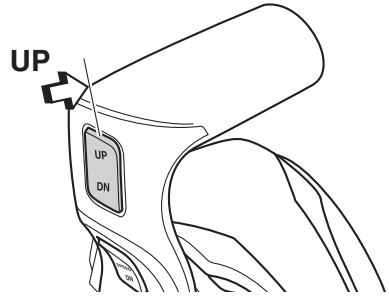

- (3) Set the tilt support lever to support the engine. **WARNING!** After tilting the outboard motor, be sure to support it with the tilt support knob or tilt support lever. Otherwise the outboard motor could fall back down suddenly if oil in the power trim and tilt unit or in the power tilt unit loses pressure. [EWM00263] **NOTICE:** Do not use the tilt support lever or knob when trailering the boat. The outboard motor could shake loose from the tilt support and fall. If the motor cannot be trailered in the normal running position, use an additional support device to secure it in the tilt position. For more detailed information, see page 68. [ECM01642]

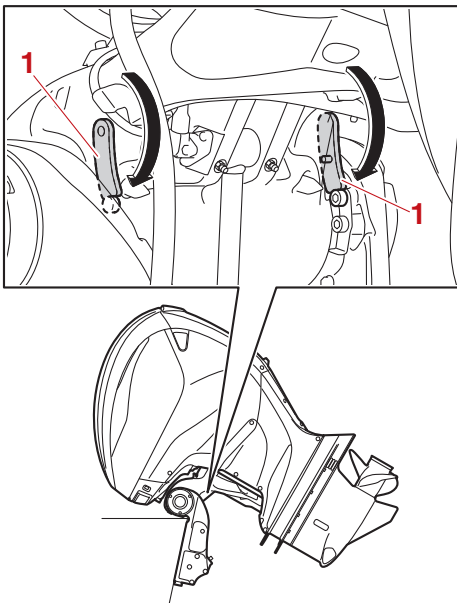

1. Tilt support lever

- (4) Once the outboard motor is supported with the tilt support lever, press the power trim and tilt switch “DN” (down) to retract the trim rods. **NOTICE:** Make sure

that the trim rods retract completely during mooring. This protects the rods from marine growth and corrosion, which could damage the power trim and tilt mechanism. [ECM00254]

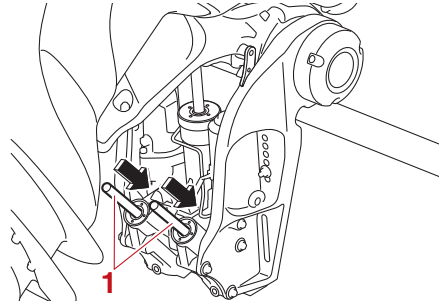

1. Trim rod

EMU42703

## Procedure for tilting down

- (1) Push the power trim and tilt switch “UP” (up) until the outboard motor is supported by the tilt rod and the tilt support lever becomes free.
- (2) Release the tilt support lever.

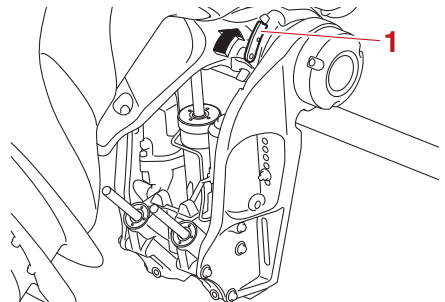

1. Tilt support lever

- (3) Push the power trim and tilt switch “DN” (down) to lower the outboard motor to the desired position.

# Operation

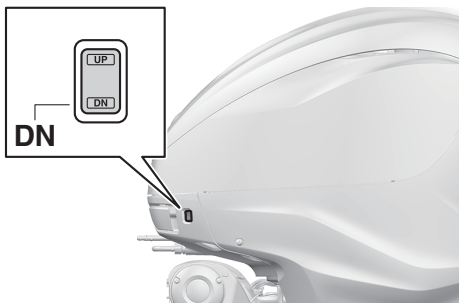
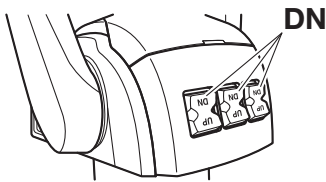
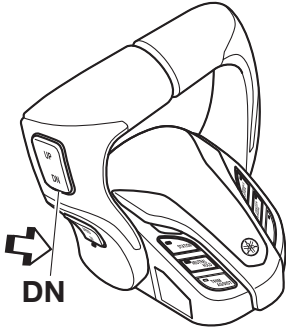
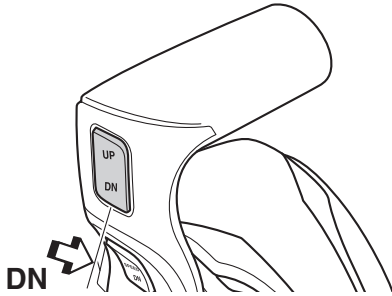

EMU28063

## Shallow water

EMU47840

### Cruising in shallow water

The outboard motor can be tilted up partially to allow operation in shallow water.

ECM01491

#### NOTICE

- If the engine speed is suddenly increased when the outboard motor is partially tilted up, the power trim and tilt unit could be damaged.
- Do not tilt the outboard motor up so that the cooling water inlet on the lower unit is above the surface of the water when setting up for and cruising in shallow water. Otherwise severe damage from overheating can result.

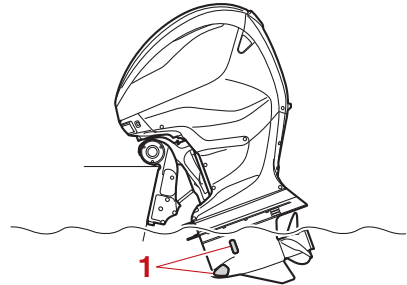

1. Cooling water inlet

#### TIP:

When the outboard motor is partially tilted up for shallow water operation, the engine speed may be controlled around 2000 r/min. The engine speed is controlled to protect the power trim and tilt unit and does not indicate a malfunction. For instructions on de-activating the engine speed control system, see page 67.

EMU49351

#### Procedure for power trim and tilt models

- (1) Place the remote control lever in neutral.



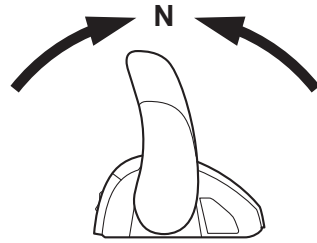
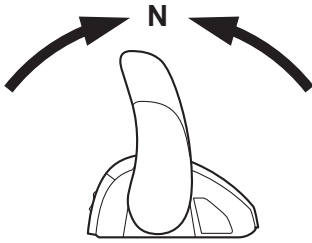

- (2) Slightly tilt the outboard motor up to the desired position using the power trim and tilt switch. **WARNING! Using the power trim and tilt switch on the bottom cowling while the boat is moving or engine is on could increase the risk of falling overboard and could distract the operator, increasing the risk of collision with another boat or an obstacle.** [EWM01851]
- (3) To return the outboard motor to the normal running position, press the power trim and tilt switch and slowly tilt the outboard motor down.

EMU47851

## De-activating the engine speed control system

ECM02501

### **NOTICE**

**This procedure must be done out of the shallow water. Otherwise, the outboard motor may hit an object in the water as tilting down.**

- (1) Close the throttle so that the engine slows to idle speed.
- (2) After the engine is at idle speed in gear, move the control lever firmly and crisply into the neutral position.

- (3) Press the power trim and tilt switch and fully tilt the outboard motor down.

EMU41371

## Operating in other conditions

### Operating in salt water

After operating in saltwater, brackish water, or water high in other minerals, flush the cooling system with fresh water to minimize corrosion and clogging of the cooling water passages with deposits. Also, rinse the exterior of the outboard motor with fresh water.

### Operating in water containing mud, sand, silt, debris, or vegetation

Mud, sand, silt, debris, and vegetation in the water may restrict water flow into the cooling water inlet covers or clog internal water passages. Check and clean the cooling water inlet covers frequently when operating in these conditions. Flush the engine with clean, fresh water after use in these environments. Consult your dealer if normal water flow can not be restored by cleaning the cooling water inlet covers or flushing with fresh water.

# Maintenance

---

EMU31846

## Transporting and storing outboard motor

EWM02641

### **WARNING**

- **USE CARE** when transporting fuel tank, whether in a boat or car.
- **DO NOT** fill fuel container to maximum capacity. Gasoline will expand considerably as it warms up and can build up pressure in the fuel container. This can cause fuel leakage and a potential fire hazard.
- Leaking fuel is a fire hazard. Tighten securely the fuel valve when transporting and storing the outboard motor.
- **Never** get under the outboard motor while it is tilted. Severe injury could occur if the outboard motor accidentally falls.
- **Do not** use the tilt support lever or knob when trailering the boat. The outboard motor could shake loose from the tilt support and fall. If the outboard motor cannot be trailered in the normal running position, use an additional support device to secure it in the tilt position.

ECM02441

### **NOTICE**

When storing the outboard motor for prolonged time, fuel must be drained from the fuel tank. The deteriorated fuel could clog the fuel line causing engine start difficulty or malfunction.

Leaking fuel is a fire hazard. When trailering the boat, close the fuel valve to prevent fuel from leaking.

When the outboard motor is tilted for a prolonged time for mooring or trailering the boat, make sure to follow the procedure listed below.

- Close the fuel valve.

The outboard motor should be transported and stored in the normal running position. If there is insufficient road clearance in this position, then trailer the outboard motor in the tilted position using a motor support device such as a transom saver bar. Consult your Yamaha dealer for further details.

EMU49380

## Storing outboard motor

When storing your Yamaha outboard motor for prolonged periods of time (2 months or longer), several important procedures must be performed to prevent excessive damage. It is advisable to have your outboard motor serviced by an authorized Yamaha dealer prior to storage. However, you, the owner, with a minimum of tools, can perform the following procedures.

ECM01721

### **NOTICE**

**Store the outboard motor in a dry, well-ventilated place, not in direct sunlight.**

Keep the outboard motor in the attitude shown when transporting and storing it.

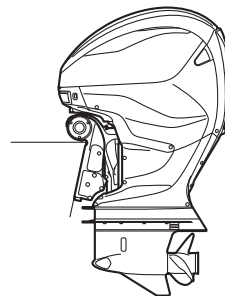

EMU47800

## Lubrication

- (1) Change the gear oil and check the gear oil for the presence of water that indicates a leaky seal. For details, consult your Yamaha dealer.
- (2) Lubricate all grease fittings. For details, see page 76.

## TIP:

For long-term storage, fogging the engine with fogging oil is recommended. Contact your Yamaha dealer for information about fogging oil and procedures for your outboard motor.

EMU47790

## Flushing cooling water passage

Perform this procedure right after operation for the most thorough flushing.

ECM01531

## NOTICE

**Do not perform this procedure while the engine is running. The water pump may be damaged and severe damage from overheating can result.**

- (1) Disconnect the garden hose connector from the fitting on the bottom cowling.

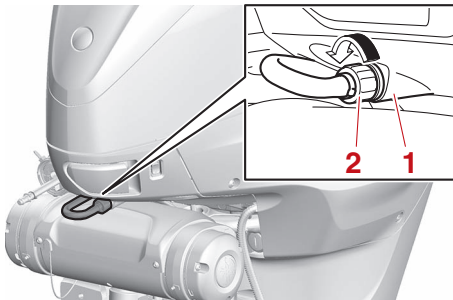

1. Fitting
2. Garden hose connector

- (2) Connect the garden hose to the garden hose connector.

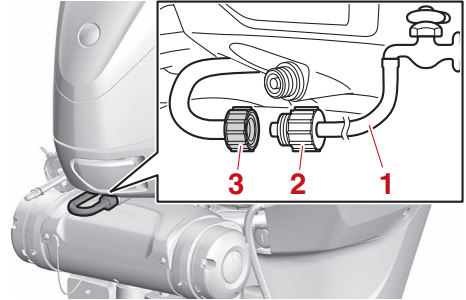

1. Garden hose
2. Garden hose adapter (commercially available)
3. Garden hose connector

- (3) With the engine off, turn on the water supply and let the water flush through the cooling water passages for about 15 minutes.
- (4) Turn off the water supply, and then disconnect the garden hose from the garden hose connector.
- (5) Connect the garden hose connector to the fitting on the bottom cowling and tighten it securely. **NOTICE: If the garden hose connector is not properly connected, cooling water can leak out and the engine can overheat during operation.** [ECM01802]

## TIP:

When flushing the cooling water passages with the boat in the water, tilting the outboard motor up until it is completely out of the water will achieve better results.

- (6) To prevent water from freezing in the cooling water passages, tilt the outboard motor down and wait at least 3 minutes or disconnect the garden hose connector to drain the water.

# Maintenance

EMU44342

## Cleaning the outboard motor

When cleaning the outboard motor, the top cowling must be installed.

- (1) Wash the exterior of the outboard motor using fresh water. **NOTICE: Do not spray water into the air intake.** [ECM01841]

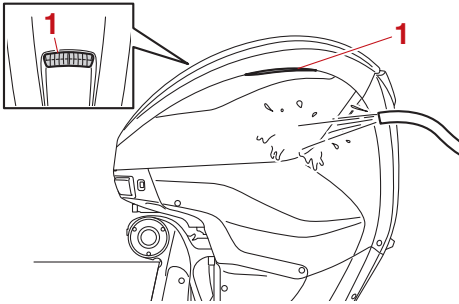

1. Air intake
- (2) Drain the cooling water completely out of the outboard motor. Clean the body thoroughly.

EMU28463

## Checking painted surface of outboard motor

Check the outboard motor for scratches, nicks, or flaking paint. Areas with damaged paint are more likely to corrode. If necessary, clean and paint the areas. Touch-up paint is available from your Yamaha dealer.

EMU2850F

## Periodic maintenance

EWM01872



**These procedures require mechanical skills, tools, and supplies. If you do not have the proper skills, tools, or supplies to perform a maintenance procedure, have a Yamaha dealer or other qualified mechanic do the work.**

The procedures involve disassembling the motor and exposing dangerous parts. To reduce the risk of injury from moving, hot, or electrical parts:

- Turn off the engine and keep the key(s) and engine shut-off cord (lanyard) with you when you perform maintenance unless otherwise specified.
- The power trim and tilt switches operate even when the ignition key is off. Keep people away from the switches whenever working around the motor. When the motor is tilted, keep away from the area under it or between it and the clamp bracket. Be sure no one is in this area before operating the power trim and tilt mechanism.
- Allow the engine to cool before handling hot parts or fluids.
- Always completely reassemble the motor before operation.

Maintenance, replacement, or repair of the emission control devices and systems on models affixed with an emission control label may be performed by any marine engine repair establishment or individual. All warranty repairs, however, including those to the emission control system, must be performed by an authorized Yamaha marine dealership.

EMU28512

## Replacement parts

If replacement parts are necessary, use only genuine Yamaha parts or parts of equivalent design and quality. Any part of inferior quality may malfunction, and the resulting loss of control could endanger the operator and passengers. Yamaha genuine parts and accessories are available from your Yamaha dealer.

EMU34152

## **Severe operating conditions**

Severe operating conditions involve one or more of the following types of operation on a regular basis:

- Operating continuously at or near maximum engine speed (rpm) for many hours
- Operating continuously at a low engine speed (rpm) for many hours
- Operating without sufficient time for engine to warm up and cool down
- Frequent quick acceleration and deceleration
- Frequent shifting
- Frequently starting and stopping the engine(s)
- Operation that fluctuates often between light and heavy cargo loads

Outboard motors operating under any of these above conditions require more frequent maintenance. Yamaha recommends that you do this service twice as often as specified in the maintenance chart. For example, if a particular service should be done at 50 hours, do it instead at 25 hours. This will help prevent more rapid deterioration of engine components.

# Maintenance

EMU46074

## Maintenance chart 1

### TIP:

- Refer to the sections in this chapter for explanations of each owner-specific action.
- The maintenance cycle on these charts assume usage of 100 hours per year and regular flushing of the cooling water passages. Maintenance frequency should be adjusted when operating the engine under adverse conditions such as extended trolling.
- Disassembly or repairs may be necessary depending on the outcome of maintenance checks.
- Expendable or consumable parts and lubricants will lose their effectiveness over time and through normal usage regardless of the warranty period.
- When operating in salt water, muddy, other turbid (cloudy), acidic water, the engine should be flushed with clean water after each use.

The “●” symbol indicates the check-ups which you may carry out yourself.

The “○” symbol indicates work to be carried out by your Yamaha dealer.

Item	Actions	Initial	Every			Page
		20 hours (3 months)	100 hours (1 year)	300 hours (3 years)	500 hours (5 years)	
Anode(s) (external)	Inspection or replacement as necessary		●/○			82
Battery (electrolyte level, terminal)	Inspection	●/○	●/○			83
Battery (electrolyte level, terminal)	Fill, charging or replacing as necessary		○			—
Cooling water leakage	Inspection or replacement as necessary	○	○			—
Cowling lock lever	Inspection		●/○			43, 46
Engine starting condition/noise	Inspection	●/○	●/○			49
Engine idle speed/noise	Inspection	●/○	●/○			78
Engine oil	Replacement	○	○			—
Engine oil filter (cartridge)	Replacement		○			—
Fuel filter (can be disassembled)	Inspection or replacement as necessary	●/○	●/○			44
Fuel line (DI pressure)	Inspection	●				—

# Maintenance

Item	Actions	Initial	Every			Page
		20 hours (3 months)	100 hours (1 year)	300 hours (3 years)	500 hours (5 years)	
Fuel line (DI pressure)	Inspection or replacement as necessary	○				—
Fuel line (High pressure)	Inspection	●	●			—
Fuel line (High pressure)	Inspection or replacement as necessary	○	○			—
Fuel line (Low pressure)	Inspection	●	●			—
Fuel line (Low pressure)	Inspection or replacement as necessary	○	○			—
Fuel pump	Inspection or replacement as necessary			○		—
Fuel/engine oil leakage	Inspection	○	○			—
Gear oil	Replacement	●/○	●/○			80
Greasing points	Greasing	●/○	●/○			76
Impeller/water pump housing	Inspection or replacement as necessary		○			—
Impeller/water pump housing	Replacement			○		—
OCV (Oil Control Valve) filter	Replacement				○	—
Power trim and tilt unit	Inspection	●/○	●/○			47
Propeller/propeller nut/cotter pin	Inspection or replacement as necessary	●/○	●/○			79
PCV (Pressure Control Valve)	Inspection or replacement as necessary		○			—
Spark plug(s)	Inspection or replacement as necessary		○			—
Water from the cooling water pilot hole	Inspection	●/○	●/○			54

# Maintenance

Item	Actions	Initial	Every			Page
		20 hours (3 months)	100 hours (1 year)	300 hours (3 years)	500 hours (5 years)	
Thermostat	Inspection or replacement as necessary		○			—
Timing belt	Inspection or replacement as necessary		○			—
Cooling water inlet	Inspection	●/○	●/○			18
Main switch/stop switch	Inspection or replacement as necessary	○	○			—
Wire harness connections/wire coupler connections	Inspection or replacement as necessary	○	○			—
(Yamaha) Meter/gauge	Inspection	○	○			—
SBW (Steer-by-wire)	Inspection or replacement as necessary	○	○	○	○	—

EMU46083

## Maintenance chart 2

Item	Actions	Every	Page
		1000 hours	
Exhaust guide/exhaust manifold	Inspection or replacement as necessary	○	—
Timing belt	Replacement	○	—
Cam chain	Inspection or replacement as necessary	○	—
Cam chain tensioner	Inspection or replacement as necessary	○	—
Valve clearance	Inspection and adjustment	○	—
Fuel strainer	Inspection or replacement as necessary	○	—
Fuel line (DI pressure)	Inspection	●	—
Fuel line (DI pressure)	Inspection or replacement as necessary	○	—



# Maintenance

Item	Actions	Every	Page
		1000 hours	
Anode(s) (internal) *1	Inspection or replacement as necessary	○	—
Anode(s) (Under the timing belt)	Inspection or replacement as necessary	○	—
SBW (Steer-by-wire)	Inspection or replacement as necessary	○	—

EMU47550

\*1 cylinder head, cylinder block, oil cooler, cooling water passage, exhaust joint

# Maintenance

EMU46621

## Greasing

Yamalube grease A “” (water resistant grease)

Yamaha grease D “” (corrosion resistant grease)

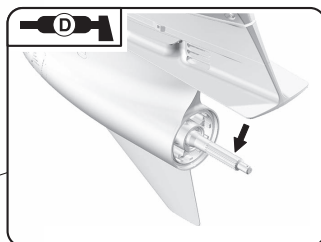
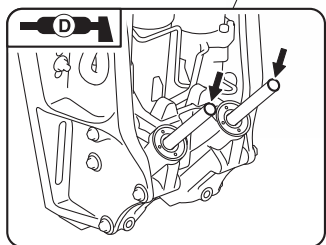
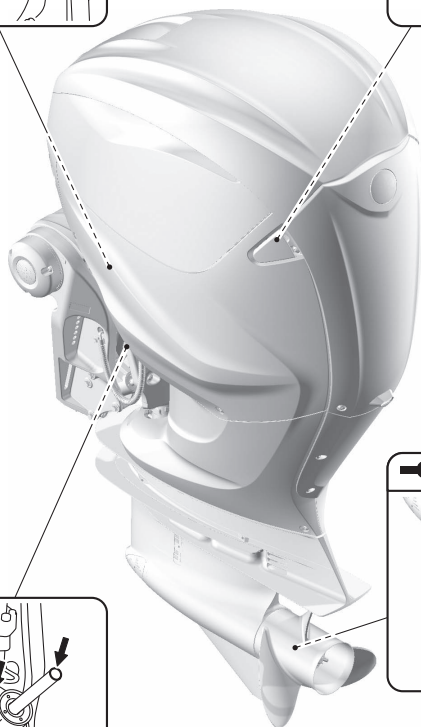
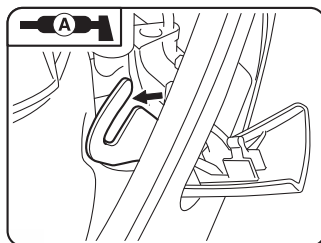
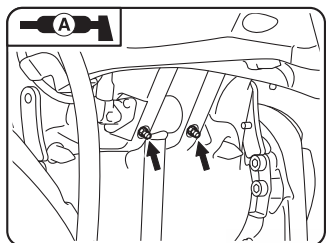

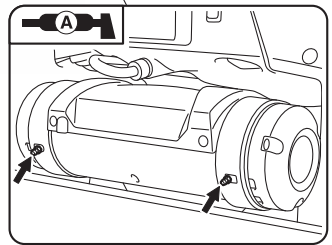
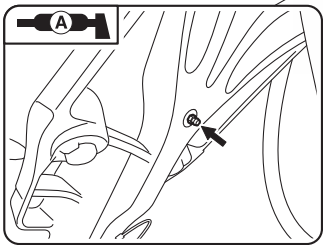
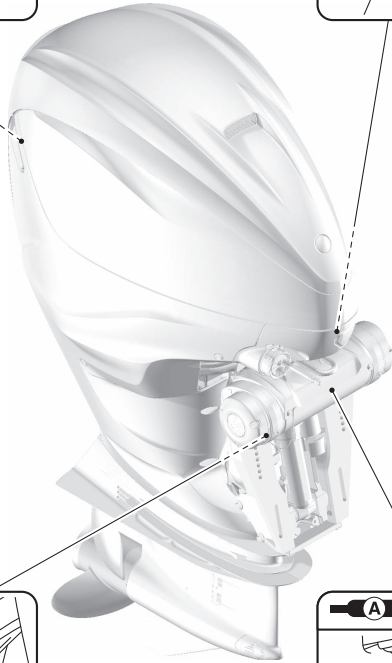
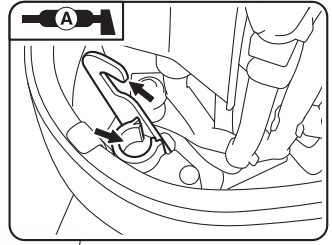
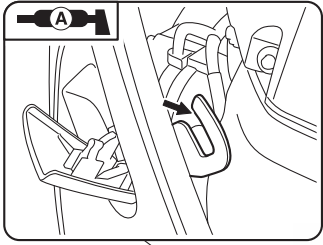

# Maintenance

EMU47591

## Inspecting spark plug

The spark plug is an important engine component. The spark plug must be checked every 100 hours. For details, consult your Yamaha dealer.

**Standard spark plug:**  
ILMAR7E-9

EMU41872

## Inspecting engine idle speed

ECM01691

### NOTICE

**This procedure must be performed while the outboard motor is in the water.**

Inspect the engine idle speed using the meter that is equipped on the boat. Results may vary depending on whether testing is conducted with the outboard motor in the water.

- (1) Start the engine and allow it to warm up fully in neutral until it is running smoothly.
- (2) Inspect the engine idle speed. If the engine idle speed is out of specification, consult a Yamaha dealer or other qualified mechanic.

**Idle speed (in neutral):**  
650–750 r/min

EMU49400

## Changing engine oil

The engine oil must be changed every 100 hours. For details, consult your Yamaha dealer.

### Recommended engine oil:

YAMALUBE 4 or 4-stroke outboard motor oil

Engine oil quantity (without oil filter replacement):

7.5 L (7.93 US qt, 6.60 Imp.qt)

Engine oil quantity (with oil filter replacement):

7.8 L (8.24 US qt, 6.86 Imp.qt)

EMU48060

## Why Yamalube

YAMALUBE oil is a Genuine YAMAHA Part born of the engineers' passion and belief that engine oil is an important liquid engine component. We form teams of specialists in the fields of mechanical engineering, chemistry, electronics and track testing, and have them develop the engine together with the oil it will use. Yamalube oils take full advantage of the base oil's qualities and blend in the ideal balance of additives to make sure the final oil clears our performance standards. Thus, Yamalube mineral, semisynthetic and synthetic oils have their own distinct characters and value. Yamaha's experience gained over many years of research and development into oil since the 1960's helps make Yamalube the best choice for your Yamaha engine.



EMU29116

## Inspecting wiring and connectors

- Inspect that each connector is engaged securely.
- Inspect that each ground lead is properly secured.

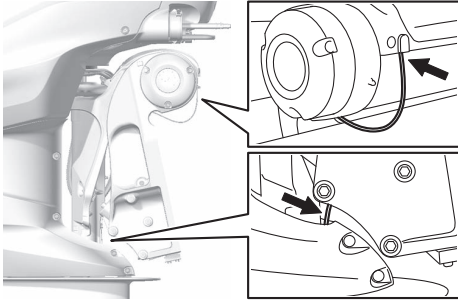

EMU41671

## Inspecting propeller

EWM02681



### WARNING

You could be seriously injured if the engine accidentally starts when you are near the propeller. Before inspecting, removing, or installing the propeller, move the control lever to the neutral position, turn the main switch to the “OFF” (off) position, remove the key, and remove the clip from the engine shut-off switch. Turn off the battery cut-off switch if your boat has one.

Do not use your hand to hold the propeller when loosening or tightening the propeller nut. Place a block of wood between the anti-cavitation plate and the propeller to prevent the propeller from turning.

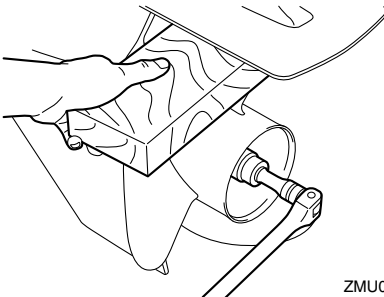

ZMU06953

Checkpoints

- Check each of the propeller blades for erosion from cavitation or ventilation, and other damage.
- Check the propeller shaft for damage.
- Check the splines for wear and damage.
- Check for fish line tangled around the propeller shaft.

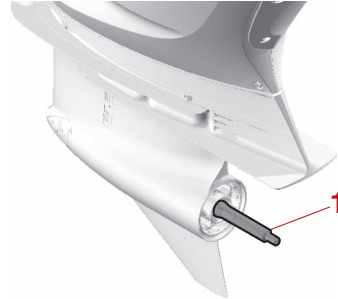

1. Propeller shaft

EMU41992

## Removing propeller

- (1) Straighten the cotter pin and pull it out using a pair of pliers.
- (2) Remove the propeller nut, washer, and spacer. **WARNING! Do not use your hand to hold the propeller when loosening the propeller nut.** [EWM01891]

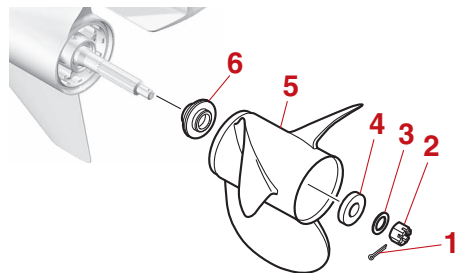

1. Cotter pin
2. Propeller nut
3. Washer
4. Spacer
5. Propeller
6. Thrust washer

# Maintenance

- (3) Remove the propeller and thrust washer.

EMU41963

## Installing propeller

EWM00771



**WARNING**

On counter rotation models, be sure to use a propeller intended for counterclockwise rotation. These propellers are identified with the letter “L” after the size indication on the propeller. Otherwise the boat could move in the opposite direction from that expected.

ECM00502

## NOTICE

Make sure to use a new cotter pin and bend the ends over securely. Otherwise, the propeller could come off during operation and be lost.

- (1) Apply Yamalube Marine Grease to the propeller shaft.
- (2) Install the thrust washer and propeller on the propeller shaft. **NOTICE: Make sure to install the thrust washer before installing the propeller. Otherwise, the lower case and propeller boss could be damaged.** [ECM01882]
- (3) Install the spacer, washer, and propeller nut. Tighten the propeller nut to the specified torque.

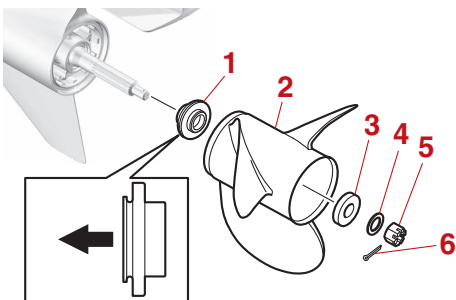

1. Thrust washer

2. Propeller
3. Spacer
4. Washer
5. Propeller nut
6. Cotter pin

**Propeller nut tightening torque:**  
80 N·m (8.0 kgf·m, 59 lb·ft)

- (4) Align the propeller nut slot with the propeller shaft hole. Insert a new cotter pin in the hole and bend the cotter pin ends. **NOTICE: Do not reuse the cotter pin. Otherwise, the propeller can come off during operation.** [ECM01892]

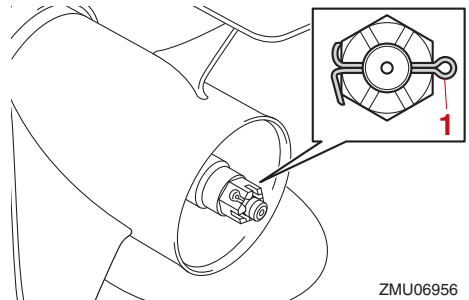

1. Cotter pin

ZMU06956

## TIP:

If the propeller nut slot does not align with the propeller shaft hole after tightening the propeller nut to the specified torque, tighten the nut further to align the slot with the hole.

EMU47942

## Changing gear oil

EWM02531



**WARNING**

- Make sure that the outboard motor is mounted securely to the transom or a stable stand. You could be severely injured if the outboard motor falls on you.

- **Never get under the lower unit while it is tilted. Severe injury could occur if the outboard motor accidentally falls.**

Before filling the lower unit with gear oil, the outboard motor must be placed in a vertical position. If you are not able to place the outboard motor in a vertical position, have a Yamaha dealer change the gear oil.

- (1) Tilt the outboard motor so that the gear oil drain bolt is at the lowest point possible.
- (2) Place a suitable container under the lower unit.
- (3) Loosen the bolts, and then remove the cooling water inlet covers on both sides of the lower unit.

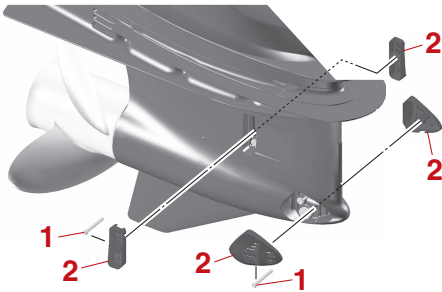

1. Bolt
2. Cooling water inlet cover

- (4) Remove the gear oil drain bolt and O-ring.

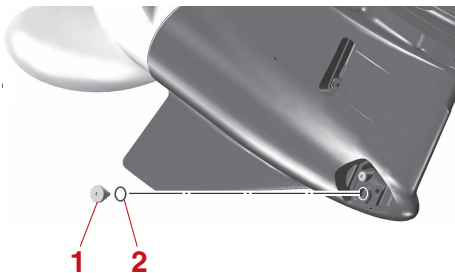

1. Gear oil drain bolt

2. O-ring

### TIP:

Always use new O-ring. Do not reuse the removed O-ring.

- (5) Remove the oil level plug and O-ring to allow the gear oil to drain completely.

**NOTICE: Check the used gear oil after it has been drained. If the gear oil is milky or contains water or a large amount of metal particles, the gear case may be damaged. Have a Yamaha dealer check and repair the outboard motor.** [ECM00714]

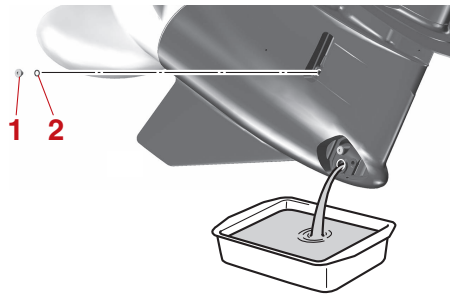

1. Oil level plug
2. O-ring

### TIP:

For disposal of used gear oil, consult your Yamaha dealer.

- (6) Remove any metal particles on the magnetic gear oil drain bolt. **NOTICE: If there is an excessive quantity of metal particles on the magnetic gear oil drain screw, this can indicate lower unit problem. Consult your Yamaha dealer.**

[ECM01901]

- (7) Put a new O-ring on the gear oil drain bolt. Insert and tighten the gear oil drain bolt to the specified torque.

# Maintenance

## TIP:

Apply a light coat of gear oil to the gear oil drain bolt thread and O-ring before installation.

### Tightening torque:

2.5 N·m (0.25 kgf·m, 1.8 lb·ft)

- (8) Remove the oil filler bolt and O-ring.

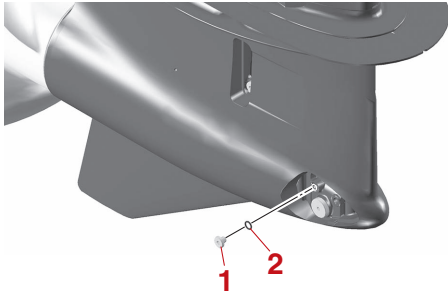

1. Oil filler bolt
2. O-ring

- (9) Put the outboard motor in a vertical position.
- (10) Using a flexible or pressurized filling device, inject the gear oil into the gear oil filler bolt hole.

### Recommended gear oil:

YAMALUBE outboard gear oil or Hypoid gear oil

### Recommended gear oil grade:

SAE 80W API GL-5 / SAE 90 API GL-5

### Gear oil quantity:

1.830 L (1.934 US qt, 1.610 Imp.qt)  
(FL375AST, FL425AST)  
1.950 L (2.061 US qt, 1.716 Imp.qt)  
(F375AST, F425AST)

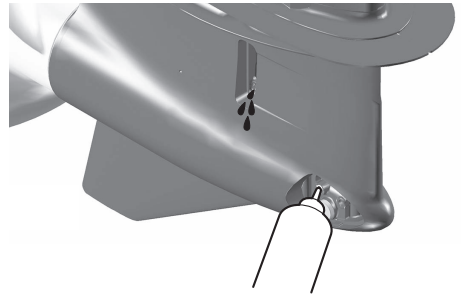

- (11) Put a new O-ring on the oil level plug. When the gear oil begins to flow out of the oil level plug hole, insert and tighten the oil level plug to the specified torque.

## TIP:

Apply a light coat of gear oil to the oil level plug thread and O-ring before installation.

### Tightening torque:

2.5 N·m (0.25 kgf·m, 1.8 lb·ft)

- (12) Put a new O-ring on the gear oil filler bolt. Insert and tighten the gear oil filler bolt to the specified torque.

## TIP:

Apply a light coat of gear oil to the gear oil filler bolt thread and O-ring before installation.

### Tightening torque:

2.5 N·m (0.25 kgf·m, 1.8 lb·ft)

- (13) Install the cooling water inlet covers on both sides of the lower unit, and then tighten the bolts to the specified torque.

### Tightening torque:

2.5 N·m (0.25 kgf·m, 1.8 lb·ft)

EMU29318

## Inspecting and replacing anode(s)

Yamaha outboard motors are protected from corrosion by sacrificial anodes. Inspect the external anodes periodically. Remove scales



from the surfaces of the anodes. Consult a Yamaha dealer for replacement of external anodes.

ECM00721

## NOTICE

**Do not paint anodes, as this would render them ineffective.**

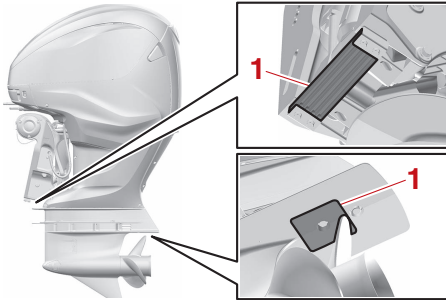

1. Anode

## TIP:

Inspect ground leads attached to external anodes on equipped models. Consult a Yamaha dealer for inspection and replacement of internal anodes attached to the power unit.

EMU29324

## Checking battery (for electric start models)

EWM01903

## WARNING

**Battery electrolyte is poisonous and caustic, and batteries generate explosive hydrogen gas. When working near the battery:**

- Wear protective eye gear and rubber gloves.
- Do not smoke or bring any other source of ignition near the battery.

The procedure for checking the battery varies for different batteries. This procedure contains typical checks that apply to many batteries, but you should always refer to the battery manufacturer's instructions.

ECM01921

## NOTICE

**A poorly maintained battery will quickly deteriorate.**

- (1) Check the electrolyte level.

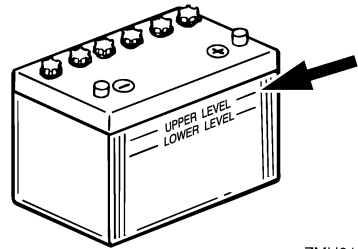

ZMU01810

- (2) Check the battery's charge. If your boat is equipped with the digital speedometer, the voltmeter and low battery alert functions will help you monitor the battery's charge. If the battery needs charging, consult your Yamaha dealer.
- (3) Check the battery connections. They should be clean, secure, and covered by an insulating cover. **WARNING! Bad connections can produce shorting or arcing and cause an explosion.** [EWM01913]

EMU35609

## Connecting the battery

EWM00573

## WARNING

**Mount the battery holder securely in a dry, well-ventilated, vibration-free location in the boat. Install a fully charged battery in the holder.**

# Maintenance

ECM01125

## NOTICE

**Do not reverse the battery cables. Otherwise, the electrical parts could be damaged.**

- (1) Make sure the main switch (on applicable models) is turned to the "OFF" (off) position before working on the battery.
- (2) Connect the positive battery cable (red) to the positive (+) terminal first. Then, connect the negative battery cable (black) to the negative (-) terminal.

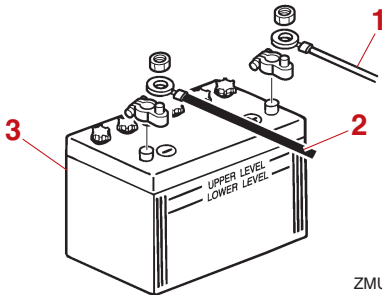

ZMU01811

1. Red cable
2. Black cable
3. Battery

- (3) The electrical contacts of the battery and cables must be clean and properly connected, or the battery will not start the engine.

### Connecting an accessory battery (optional)

If connecting an accessory battery, consult your Yamaha dealer about correct wiring. It is recommendable to install the fuse to the isolator lead as shown in the illustration. For the fuse size, be sure to follow local regulations. For example, for USA, the ABYC rules (E-11) should be observed.

## Single engine

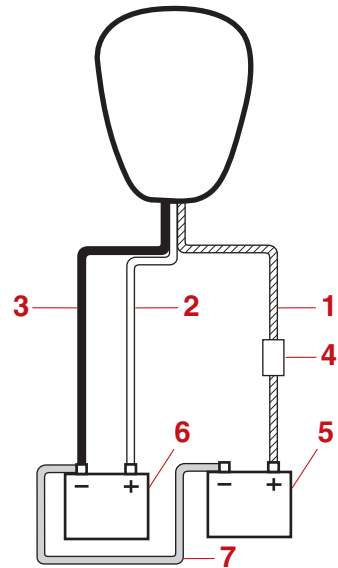

1. Isolator lead with circuit protection
2. Red cable
3. Black cable
4. Fuse
5. Battery for accessories
6. Battery for starting
7. Negative connecting cable

## Twin engines

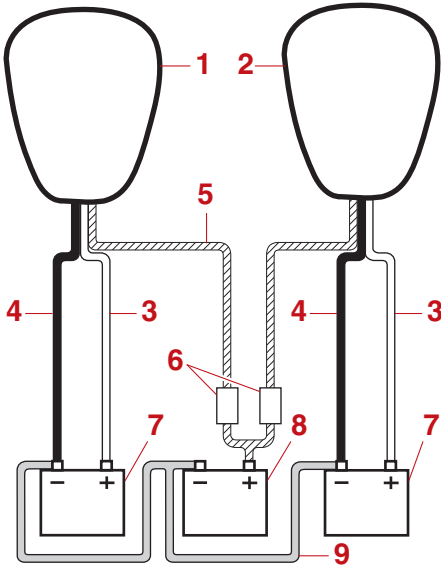

1. Starboard side engine
2. Port side engine
3. Red cable
4. Black cable
5. Isolator leads with circuit protection
6. Fuse
7. Battery for starting
8. Battery for accessories
9. Negative connecting cable

## Triple engines

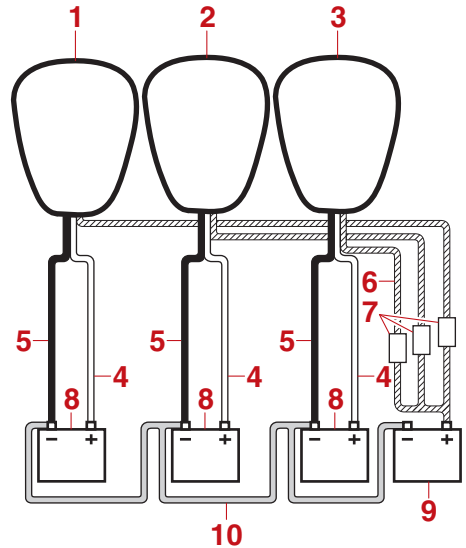

1. Starboard side engine
2. Center engine
3. Port side engine
4. Red cable
5. Black cable
6. Isolator leads with circuit protection
7. Fuse
8. Battery for starting
9. Battery for accessories
10. Negative connecting cable

EMU29372

### Disconnecting the battery

- (1) Turn off the battery cut-off switch (if equipped) and main switch. **NOTICE: If they are left on, the electrical system can be damaged.** [ECM01931]
- (2) Disconnect the negative cable(s) from the negative (-) terminal. **NOTICE: Always disconnect all negative (-) cables first to avoid a short circuit and damage to the electrical system.** [ECM01941]

# Maintenance

---

- (3) Disconnect the positive cable(s) and remove the battery from the boat.
- (4) Clean, maintain, and store the battery according to the manufacturer's instructions.

# Trouble Recovery

EMU47901

## Troubleshooting

This section describes the likely causes and remedies for problems, such as those in the fuel, compression, and ignition systems, poor starting, and loss of power. Please note that all of the items in this section may not apply to your model.

If your outboard motor requires repair, bring it to a Yamaha dealer.

If the engine trouble-alert indicator is blinking, consult your Yamaha dealer.

<b>Trouble</b>	<b>Starter will not operate.</b>	
<b>Item</b>	<b>Question</b>	<b>Answer</b>
<b>DEC alert indicator</b>	Does the DEC alert indicator come on in orange?	Have serviced by a Yamaha dealer.
<b>Control lever</b>	Is control lever in gear?	Shift to neutral.
<b>Battery</b>	Is battery capacity low or weak?	Check battery condition. Use battery of recommended capacity.
	Are battery connections corroded or loose?	Tighten battery cables and clean battery terminals.
<b>Fuse</b>	Is fuse for starter relay or electric circuit blown?	Check for cause of electric overload and repair. Replace fuse with one of correct amperage.
<b>Starter</b>	Are starter components malfunctioning?	Have serviced by a Yamaha dealer.

<b>Trouble</b>	<b>Engine will not start (starter operates).</b>	
<b>Item</b>	<b>Question</b>	<b>Answer</b>
<b>Engine shut-off cord (lanyard)</b>	Is clip on engine shut-off cord (lanyard) installed?	Install clip to engine shut-off switch.
<b>Fuel tank</b>	Is fuel tank empty?	Fill tank with clean, fresh fuel.
<b>Fuel</b>	Is fuel contaminated or stale?	Fill tank with clean, fresh fuel.
<b>Fuel filter</b>	Is fuel filter clogged?	Clean or replace fuel filter.
<b>Fuel pump</b>	Is fuel pump malfunctioning?	Have serviced by a Yamaha dealer.
<b>Spark plugs</b>	Are spark plugs fouled or of incorrect type?	Inspect spark plugs. Clean or replace with recommended type.
<b>Ignition parts</b>	Are ignition parts malfunctioning?	Have serviced by a Yamaha dealer.
<b>Ignition wiring</b>	Is ignition wiring damaged or poorly connected?	Inspect wires for breaks and wear. Have connections tightened and broken or worn wires replaced by a Yamaha dealer.
<b>Engine inner parts</b>	Are engine inner parts damaged?	Have serviced by a Yamaha dealer.

# Trouble Recovery

<b>Trouble</b>	<b>Engine idles irregularly or stalls.</b>	
<b>Item</b>	<b>Question</b>	<b>Answer</b>
<b>Spark plugs</b>	Are spark plugs fouled or of incorrect type?	Inspect spark plugs. Clean or replace with recommended type.
	Is spark plug gap incorrect?	Replace spark plug.
<b>Fuel system</b>	Is fuel system clogged?	Inspect for pinched or kinked fuel line or other obstructions in fuel system.
<b>Fuel</b>	Is fuel contaminated or stale?	Fill tank with clean, fresh fuel.
<b>Fuel filter</b>	Is fuel filter clogged?	Clean or replace fuel filter.
<b>Ignition parts</b>	Are ignition parts malfunctioning?	Have serviced by a Yamaha dealer.
<b>Alert system</b>	Has alert system activated?	Find and correct cause of alert.
<b>Ignition wiring</b>	Is ignition wiring damaged or poorly connected?	Inspect wires for breaks and wear. Have connections tightened and broken or worn wires replaced by a Yamaha dealer.
<b>Engine oil</b>	Is specified engine oil not being used?	Inspect engine oil and replace with specified type.
<b>Thermostat</b>	Is thermostat clogged or malfunctioning?	Have serviced by a Yamaha dealer.
<b>Fuel pump</b>	Is fuel pump malfunctioning?	Have serviced by a Yamaha dealer.
<b>Fuel tank</b>	Is fuel tank air vent restricted or clogged?	Remove obstruction.
<b>Fuel joint</b>	Is fuel joint connection incorrect?	Connect correctly.
<b>Battery</b>	Is battery cable disconnected?	Connect securely.

<b>Trouble</b>	<b>Alert buzzer sounds or indicator lights.</b>	
<b>Item</b>	<b>Question</b>	<b>Answer</b>
<b>Cooling system</b>	Is cooling system clogged?	Inspect cooling water inlet for obstructions.
<b>Low oil pressure-alert</b>	Is low oil pressure-alert indicator on or blinking?	Have serviced by a Yamaha dealer.
<b>Spark plugs</b>	Is heat range of spark plugs incorrect?	Inspect spark plugs and replace with recommended type.
<b>Engine oil</b>	Is specified engine oil not being used?	Inspect engine oil and replace with specified type.
	Is engine oil contaminated or deteriorated?	Replace engine oil with specified type.
<b>Oil filter</b>	Is oil filter clogged?	Have serviced by a Yamaha dealer.
<b>Oil pump</b>	Is oil pump malfunctioning?	Have serviced by a Yamaha dealer.
<b>Thermostat</b>	Is thermostat malfunctioning?	Have serviced by a Yamaha dealer.
<b>Water pump</b>	Is water pump malfunctioning?	Have serviced by a Yamaha dealer.
<b>Fuel filter</b>	Is there excess water in fuel filter?	Drain fuel filter.

# Trouble Recovery

<b>Trouble</b>	<b>Engine power loss.</b>	
<b>Item</b>	<b>Question</b>	<b>Answer</b>
<b>Propeller</b>	Is propeller damaged?	Have propeller repaired or replaced.
	Is propeller pitch or diameter incorrect?	Install correct propeller to operate outboard motor at its recommended speed (r/min) range.
<b>Mounting height</b>	Is outboard motor mounted at incorrect height on transom?	Have outboard motor adjusted to proper transom height.
<b>Alert system</b>	Has alert system activated?	Find and correct cause of alert.
<b>Boat bottom</b>	Is boat bottom fouled with marine growth?	Clean boat bottom.
<b>Spark plugs</b>	Are spark plugs fouled or of incorrect type?	Inspect spark plugs. Clean or replace with recommended type.
	Is spark plug gap incorrect?	Replace spark plug.
	Is heat range of spark plugs incorrect?	Inspect spark plugs and replace with recommended type.
<b>Lower unit</b>	Are weeds or other foreign material tangled on gear housing?	Remove foreign material and clean lower unit.
<b>Fuel system</b>	Is fuel system clogged?	Inspect for pinched or kinked fuel line or other obstructions in fuel system.
<b>Fuel filter</b>	Is fuel filter clogged?	Clean or replace fuel filter.
<b>Fuel</b>	Is fuel contaminated or stale?	Fill tank with clean, fresh fuel.
	Is specified fuel not being used?	Replace fuel with specified type.
<b>Ignition wiring</b>	Is ignition wiring damaged or poorly connected?	Inspect wires for breaks and wear. Have connections tightened and broken or worn wires replaced by a Yamaha dealer.
<b>Electrical parts</b>	Are electrical parts malfunctioning?	Have serviced by a Yamaha dealer.
<b>Engine oil</b>	Is specified engine oil not being used?	Replace engine oil with specified type.
<b>Thermostat</b>	Is thermostat clogged or malfunctioning?	Have serviced by a Yamaha dealer.
<b>Fuel tank</b>	Is fuel tank air vent restricted or clogged?	Remove obstruction.
<b>Fuel pump</b>	Is fuel pump malfunctioning?	Have serviced by a Yamaha dealer.
<b>Fuel joint</b>	Is fuel joint connection incorrect?	Connect correctly.
<b>Control lever</b>	Is engine not responding properly to control lever position?	Have serviced by a Yamaha dealer.

<b>Trouble</b>	<b>Engine vibrates excessively.</b>	
<b>Item</b>	<b>Question</b>	<b>Answer</b>
<b>Propeller</b>	Is propeller damaged?	Have propeller repaired or replaced.
	Are weeds or other foreign material tangled on propeller?	Remove and clean propeller.

# Trouble Recovery

Trouble	Engine vibrates excessively.	
Item	Question	Answer
Propeller shaft	Is propeller shaft damaged?	Have serviced by a Yamaha dealer.
Outboard motor mounting	Are outboard motor mounting bolts loose?	Tighten bolts or have serviced by a Yamaha dealer.
Steering pivot	Is steering pivot loose or damaged?	Have serviced by a Yamaha dealer.

EMU29436

## Temporary action in emergency

EMU29442

### Impact damage

EWM00871



The outboard motor can be seriously damaged by a collision while operating or trailering. Damage could make the outboard motor unsafe to operate.

If the outboard motor hits an object in the water, follow the procedure below.



- (1) Stop the engine immediately.
- (2) Check the control system and all components for damage. Also, check the boat for damage.
- (3) Whether damage is found or not, return to the nearest harbor slowly and carefully.
- (4) Have a Yamaha dealer check the outboard motor before operating it again.

EMU35791

## Running in an emergency (twin engines or triple engines)

Normally use all outboard motors together for cruising. When using only one or two engines in an emergency, be sure to keep the unused engine(s) tilted up and operate the other engine(s) at low speed.

ECM01731

### NOTICE

If the boat is operated with only one or two engines, be sure to tilt the unused engine(s) up. Otherwise water could enter the exhaust pipe due to the wave action, causing engine trouble.

### TIP:

When maneuvering at low speed, such as near a dock, it is recommended to tilt the unused engine(s) down and to operate the unused engine(s) in neutral gear if possible.

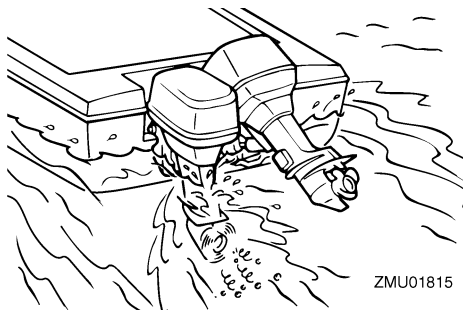



EMU47622

## Replacing fuse

EWM00632



**WARNING**

**Substituting an incorrect fuse or a piece of wire could allow excessive current flow. This could cause electric system damage and a fire hazard.**

The location of the fuse box for this model is shown in the following illustration.

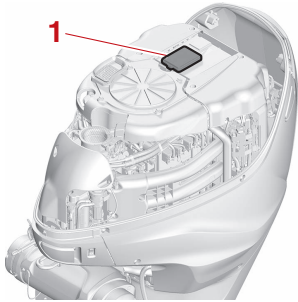

1. Fuse box

This model is equipped with the following fuses.

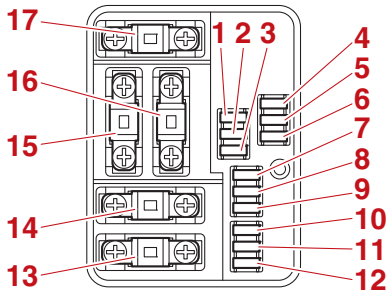

1. RC-ECU fuse (10 A)
2. Main switch / PTT switch fuse (20 A)
3. ETV fuse (10 A)
4. Fuel pump 2 fuse (15 A)
5. Fuel pump 1 fuse (15 A)
6. Fuel pump fuse (30 A)
7. Shift actuator fuse (15 A)
8. Starter relay fuse (30 A)
9. DI system 2 fuse (20 A)

10. DI system 1 fuse (20 A)
11. Engine ECU / Ignition coil fuse (30 A)
12. Fuel feed pump fuse (10 A)
13. Isolator 1 fuse (70 A)
14. Isolator 2 fuse (70 A)
15. Engine main 1 fuse (70 A)
16. Engine main 2 fuse (70 A)
17. Power STRG fuse (100 A)

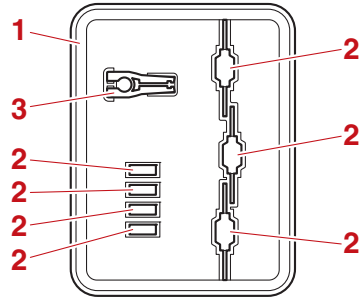

1. Fuse box cover
2. Spare fuse (10 A, 15 A, 20 A, 30 A, 70 A, 100 A)
3. Fuse puller

### TIP:

- RC: Remote control
- ETV: Electric throttle valve
- DI: Direct injection
- ECU: Engine control unit
- STRG: Steering
- PTT: Power trim and tilt

If a fuse has blown, replace the fuse according to the following procedure.

- (1) Turn the main switch to the "OFF" (off) position.
- (2) Remove the fuse box cover.
- (3) If the fuse is secured using screws, remove the screws, and then remove the fuse. Install the spare fuse of the proper amperage, and then tighten the screws.

# Trouble Recovery

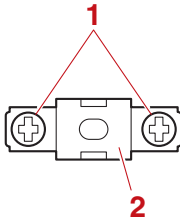

1. Screw
2. Fuse

- (4) If the fuse is not secured using screws, remove the fuse using the fuse puller, and then install a spare fuse of the proper amperage.

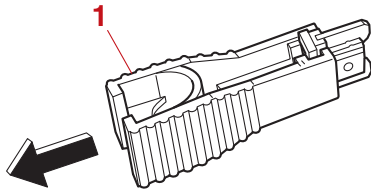

1. Fuse puller

Consult your Yamaha dealer if the new fuse immediately blows again.

EMU29529

## Power trim and tilt will not operate

EWM02331



**Never get under the engine while it is tilted. Severe injury could occur if the outboard motor accidentally falls.**

If the outboard motor cannot be tilted up/down using the power trim and tilt unit, e.g. because of a discharged battery or a failure with the unit itself, the outboard motor can be tilted manually.

- (1) Stop the engine.
- (2) Loosen the manual valve screw by turning it counterclockwise until it stops.

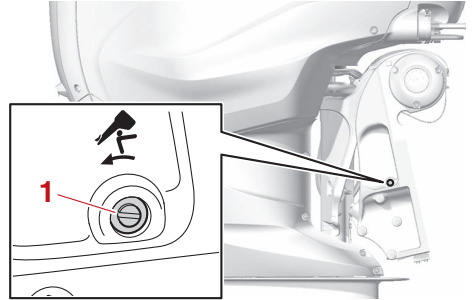

1. Manual valve screw

- (3) Adjust the outboard motor to a navigable angle, tighten the manual valve screw clockwise, and secure the outboard motor.

EMU47560

## Steer-by-wire system will not operate

If the steer-by-wire system does not operate, the outboard motor can be steered manually.

### To steer the outboard motor manually

- (1) Remove the clamp bracket cover by removing the bolts.

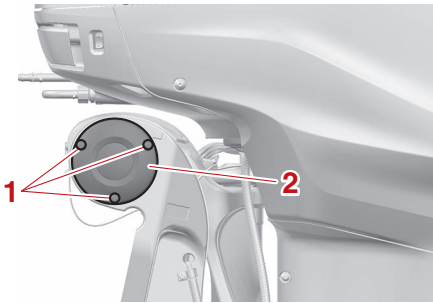

1. Bolt
2. Clamp bracket cover

(2) Loosen the nut until it stops.

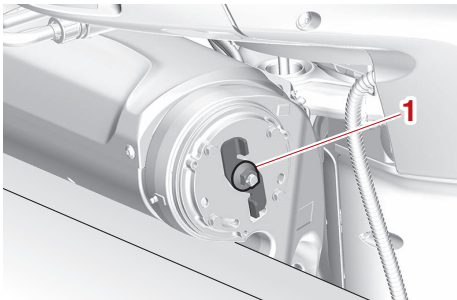

1. Nut

(3) To steer the outboard motor to the port side, turn the lever counterclockwise. To steer the outboard motor to the starboard side, turn the lever clockwise.

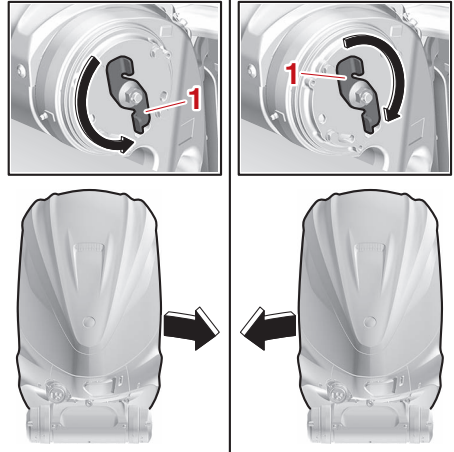

1. Lever

EMU47612

**Water separator-alert is activated after leaving port**

EWM01501



**WARNING**

**Gasoline is highly flammable, and its vapors are flammable and explosive.**

- Do not perform this procedure on a hot or running engine. Allow the engine to cool.
- There will be fuel in the fuel filter. Keep away from sparks, cigarettes, flames or other sources of ignition.
- This procedure will allow some fuel to spill. Catch fuel in a rag. Wipe up any spilled fuel immediately.
- The fuel filter must be reassembled carefully with the O-ring, filter cup, and hoses in place. Improper assembly or replacement could result in a fuel leak, which could result in a fire or explosion hazard.

If the water separator-alert indicator blinks or the buzzer sounds intermittently, perform the following procedure.

# Trouble Recovery

## TIP:

The buzzer sounds only when the remote control lever is placed in neutral.

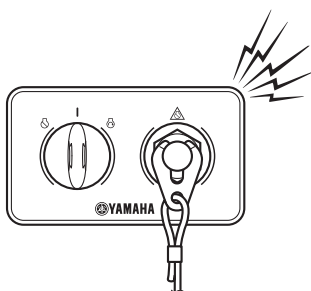
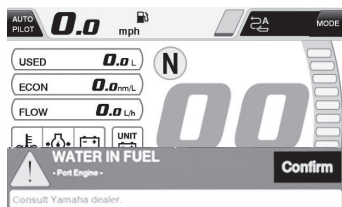

### To check for water in separator

- (1) Stop the engine.
- (2) Remove the top cowling.
- (3) Remove the fuel filter housing from its holder.

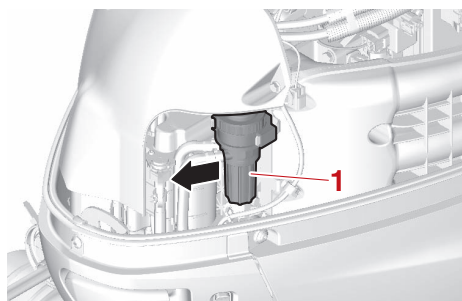

1. Fuel filter

- (4) Remove the fuel filter cap, and then remove the fuel filter element and O-ring from the filter cup.

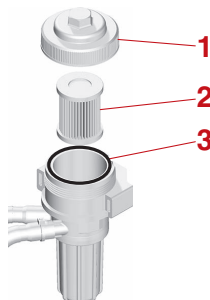

1. Fuel filter cap
  2. Filter element
  3. O-ring
- (5) Drain the water in the filter cup by soaking it up with a rag.
  - (6) Put the O-ring on the filter cup in its original position, and then install the fuel filter element and fuel filter cap.
  - (7) Install the fuel filter housing onto its holder.
  - (8) Install the top cowling.
  - (9) Turn the main switch to the "ON" (on) position and check that the water separator-alert indicator remains off and the buzzer does not sound. If the water separator-alert indicator blinks or the buzzer sounds, have your Yamaha dealer check the outboard motor. **NOTICE: Although the buzzer will stop when the engine is started and the remote control lever is moved to the forward or reverse position, do not use the outboard motor. Otherwise, serious engine damage could occur.** [ECM02391]

EMU33502

## Treatment of submerged motor

If the outboard motor is submerged, immediately take it to a Yamaha dealer. Otherwise some corrosion may begin almost immedi-

ately. **NOTICE:** Do not attempt to run the outboard motor until it has been completely inspected.<sup>[ECM00402]</sup>

# INDEX

---

- 6X6 switch ..... 28
- A**
- Alcohol and drugs..... 2
  - Alert system..... 36
  - All Start/Stop switch panel (optional) ... 29
  - Anode(s), inspecting and replacing ..... 82
  - Anti-fouling paint ..... 16
  - Approval label of emission control certificate..... 16
  - Avoid collisions..... 3
- B**
- Battery ..... 48
  - Battery, checking (electric start models)..... 83
  - Battery, connecting ..... 83
  - Battery, disconnecting..... 85
  - Battery requirements ..... 13
  - Boat direction ..... 59
  - Boat horsepower rating ..... 12
  - Boating safety..... 2
  - Boating safety publications ..... 4
  - Breaking in engine..... 42
- C**
- Carbon monoxide ..... 2
  - CE Marking / UKCA Marking..... 5
  - Center engine switch ..... 27
  - Center engine switch operation..... 56
  - Checks after engine warm up..... 55
  - Checks after starting engine..... 54
  - Checks before starting engine..... 43
  - CL5 Display ..... 33
  - Cleaning the outboard motor ..... 70
  - Collisions with floating or submerged objects..... 3
  - Compliance mark label..... 6
  - Components diagram..... 18
  - Control functions, checking..... 44
  - Control lever ..... 24
  - Cooling water ..... 54
  - Cowling lock lever ..... 31
- D**
- De-activating the engine speed control system ..... 67
  - DEC alert indicator..... 25
  - Digital electronic control ..... 23
  - Digital electronic control alert ..... 36
  - Digital electronic control requirements ..... 12
- E**
- EC Declaration of Conformity (DoC)..... 5
  - Electric shock ..... 1
  - Emergency equipment..... 16
  - Emergency, running in an ..... 90
  - Emergency, temporary action in..... 90
  - Emission control information ..... 16
  - Engine data recording ..... 9
  - Engine idle speed, inspecting..... 78
  - Engine oil ..... 45
  - Engine oil, changing ..... 78
  - Engine oil, filling ..... 42
  - Engine oil requirements ..... 15
  - Engine shut-off cord (lanyard) ..... 1, 45
  - Engine shut-off cord (lanyard) and clip ..... 29
- F**
- Filling fuel..... 48
  - First-time operation ..... 42
  - Flushing cooling water passage ..... 69
  - Flushing device ..... 31, 46
  - Fuel filter ..... 32
  - Fuel filter, checking..... 44
  - Fuel leaks, checking for ..... 44
  - Fuel level..... 43
  - Fuel requirements ..... 15
  - Fuel system..... 44
  - Fuse, replacing ..... 91
- G**
- Gasoline ..... 2, 15
  - Gasoline exposure and spills..... 2
  - Gear oil, changing..... 80
  - Greasing ..... 76

<b>H</b>		Overloading .....	3
	Helm Master control system alert.....		36
	Helm Master EX (upgradable).....		22
	Hot parts.....		1
<b>I</b>			
	Identification numbers record.....		5
	Impact damage.....		90
	Installation requirements .....		12
<b>K</b>			
	Key number .....		5
<b>L</b>			
	Laws and regulations.....		4
	Low oil pressure alert .....		37
	Lubrication.....		69
<b>M</b>			
	Main switch .....		28
	Maintenance chart 1 .....		72
	Maintenance chart 2 .....		74
	Modifications .....		2
	Mounting height.....		40
	Mounting outboard motor .....		12
	Mounting the outboard motor .....		40
<b>N</b>			
	Neutral hold switch.....		26
	Neutral hold switch operation.....		56
<b>O</b>			
	Operating engine .....		49
	Operating in salt water or other conditions.....		67
	Outboard motor, checking .....		45
	Outboard motor disposal requirements .....		16
	Outboard motor equipment.....		30
	Outboard motor (painted surface), checking .....		70
	Outboard motor safety .....		1
	Outboard motor serial number .....		5
	Overheat alert .....		36
<b>P</b>			
	Passenger training .....		4
	Passengers .....		2
	People in the water .....		2
	Periodic maintenance .....		70
	Personal flotation devices (PFDs).....		2
	Power trim and tilt .....		1
	Power trim and tilt switch (bottom cowling) .....		30
	Power trim and tilt switches .....		24
	Power trim and tilt system, checking ...		47
	Power trim and tilt will not operate.....		92
	Propeller .....		1
	Propeller (counter rotation models) .....		14
	Propeller, inspecting .....		79
	Propeller, installing .....		80
	Propeller, removing.....		79
	Propeller selection .....		14
<b>R</b>			
	Read manuals and labels .....		7
	Replacement parts .....		70
	Rotating parts .....		1
<b>S</b>			
	Sending fuel.....		49
	Severe operating conditions.....		71
	Shallow water .....		66
	Shifting.....		55
	Shifting (checks after engine warm up).....		55
	Single lever switch .....		27
	Single lever switch operation.....		57
	Spark plug, inspecting.....		78
	Specifications .....		11
	Speed control switch.....		25
	Starting engine.....		49
	Start-in-gear protection .....		14
	Start/Stop switch panel .....		29
	Station selector switch .....		26
	Steer-by-wire system will not operate .....		92

# INDEX

---

Stop switches .....	55
Stopping boat .....	58
Stopping engine .....	61
Storing outboard motor .....	68
Submerged outboard motor .....	94

## T

Tilt limiter .....	30
Tilt support lever .....	30
Tilting up and down .....	63
Top cowling, installing .....	46
Top cowling, removing .....	43
Transporting and storing outboard motor .....	68
Trimming outboard motor .....	61
Troubleshooting .....	87

## W

Warming up engine .....	55
Warning labels .....	7
Water separator alert .....	38
Water separator-alert is activated after leaving port .....	93
Weather .....	4
Wiring and connectors, inspecting .....	78

## Y

Yamalube .....	78
----------------	----







Printed in Japan  
January 2023-0.1 × 1 CR