

F175
F200
LF200

OWNER'S MANUAL

▲ Read this manual carefully before operating this outboard motor.

LIT-18626-14-33
6LW-28199-30-E0

 **WARNING:** This product can expose you to chemicals including engine exhaust, which is known to the State of California to cause cancer, and carbon monoxide, which is known to the State of California to cause birth defects or other reproductive harm. For more information go to www.P65Warnings.ca.gov.

Ce produit peut vous exposer à des produits chimiques y compris aux gaz d'échappement, qui sont considérés par l'état de Californie comme étant cancérogènes, et au monoxyde de carbone, qui est considéré par l'état de Californie comme un facteur de malformations congénitales ou d'autres troubles de la reproduction. Pour plus d'informations, rendez-vous sur www.P65Warnings.ca.gov.

ZMU08844

Read this manual carefully before operating this outboard motor. Keep this manual onboard in a waterproof bag when boating. This manual should stay with the outboard motor if it is sold.

Important manual information

EMU44141

To the owner

Thank you for selecting a Yamaha outboard motor. This Owner's Manual contains information needed for proper operation, maintenance and care. A thorough understanding of these simple instructions will help you obtain maximum enjoyment from your new Yamaha. If you have any question about the operation or maintenance of your outboard motor, please consult a Yamaha dealer.

In this Owner's Manual particularly important information is distinguished in the following ways.

 : This is the safety alert symbol. It is used to alert you to potential personal injury hazards. Obey all safety messages that follow this symbol to avoid possible injury or death.

EWMM00782

WARNING

A WARNING indicates a hazardous situation which, if not avoided, could result in death or serious injury.

ECM00702

NOTICE

A NOTICE indicates special precautions that must be taken to avoid damage to the outboard motor or other property.

TIP:

A TIP provides key information to make procedures easier or clearer.

Yamaha continually seeks advancements in product design and quality. Therefore, while this manual contains the most current product information available at the time of printing, there may be minor discrepancies

between your machine and this manual. If there is any question concerning this manual, please consult your Yamaha dealer.

To ensure long product life, Yamaha recommends that you use the product and perform the specified periodic inspections and maintenance by correctly following the instructions in the owner's manual. Any damage resulting from neglect of these instructions is not covered by warranty.

Some countries have laws or regulations restricting users from taking the product out of the country where it was purchased, and it may be impossible to register the product in the destination country. Additionally, the warranty may not apply in certain regions. When planning to take the product to another country, consult the dealer where the product was purchased for further information.

If you purchased this outboard motor used, see your Yamaha dealer to have it registered in your name in Yamaha records.

TIP:

The F175B, F200C, LF200C and the standard accessories are used as a base for the explanations and illustrations in this manual. Therefore some items may not apply to every model.

EMU44152

**F175, F200, LF200
OWNER'S MANUAL**
©2023 by Yamaha Motor Co., Ltd.
1st Edition, October 2022
All rights reserved.
Any reprinting or unauthorized use
without the written permission of
Yamaha Motor Co., Ltd.
is expressly prohibited.
Printed in Japan

Table of contents

Safety information	1	EC Declaration of Conformity (DoC).....	10
Outboard motor safety.....	1	CE Marking / UKCA Marking	10
Propeller.....	1	Compliance mark label.....	11
Rotating parts.....	1	Read manuals and labels	12
Hot parts	1	Warning labels	12
Electric shock.....	1	Engine data recording	14
Power trim and tilt.....	1		
Engine shut-off cord (lanyard).....	1		
Gasoline	2	Specifications and requirements	15
Gasoline exposure and spills	2	Specifications	15
Carbon monoxide	2	Installation requirements	16
Modifications.....	2	Boat horsepower rating.....	16
Boating safety	2	Mounting outboard motor	16
Alcohol and drugs	2	Remote control requirements	16
Personal flotation devices (PFDs)	2	Battery requirements	17
People in the water	2	Battery specifications.....	17
Passengers.....	2	Propeller selection	18
Overloading.....	3	Counter rotation models	18
Avoid collisions	3	Start-in-gear protection	18
Collisions with floating or submerged objects	3	Engine oil requirements	19
Weather	4	Hydraulic steering fluid requirements.....	19
Accident reporting.....	4	Fuel requirements.....	19
Boat education and training.....	4	Gasoline	19
Passenger training	5	Gasoline Additives.....	21
Boating safety publications.....	5	Muddy or acidic water	21
Laws and regulations	5	Anti-fouling paint	21
Boating organizations	5	Outboard motor disposal requirements.....	22
Basic boating rules (Rules of the road)	6	Emergency equipment.....	22
Steering and sailing rules and sound signals.....	6	Emission control information	22
Rules when encountering vessels.....	6	Star labels	23
Other special situations.....	7		
		Components	25
General information	10	Components diagram	25
Identification numbers record	10	Optional items	27
Outboard motor serial number.....	10	Yamaha Security System (Y-COP/Optional)	27
Key number	10	Remote control box.....	28
		Remote control lever	29
		Neutral interlock trigger.....	29

Table of contents

Neutral throttle lever.....	29	CL5 Display.....	43
Free accelerator.....	30	6Y8 Multifunction meters.....	45
Throttle friction adjuster.....	30		
Engine shut-off cord (lanyard) and clip.....	31	Engine control system.....	49
Main switch.....	32	Alert system.....	49
Power trim and tilt switch on remote control.....	32	Overheat alert.....	49
Power trim and tilt switch on bottom cowling.....	33	Low oil pressure alert.....	50
Power trim and tilt switches (twin binnacle type).....	33	Water separator alert.....	51
Trim tab with anode.....	34	Installation.....	53
Tilt support lever for power trim and tilt model.....	34	Installation.....	53
Cowling lock lever.....	35	Mounting the outboard motor.....	53
Flushing device.....	35		
Fuel filter.....	36	Operation.....	55
Instruments and indicators.....	37	First-time operation.....	55
Digital tachometer.....	37	Filling engine oil.....	55
Tachometer.....	37	Breaking in engine.....	55
Trim meter.....	37	Getting to know your boat.....	55
Hour meter.....	37	Checks before starting engine.....	56
Low oil pressure-alert indicator.....	38	Fuel level.....	56
Overheat-alert indicator.....	38	Removing top cowling.....	56
Digital speedometer.....	38	Fuel system.....	56
Speedometer.....	38	Controls.....	57
Fuel gauge.....	39	Engine shut-off cord (lanyard).....	57
Trip meter / Clock / Voltmeter.....	39	Engine oil.....	57
Fuel level-alert indicator.....	40	Outboard motor.....	58
Low battery voltage-alert indicator.....	40	Flushing device.....	58
Fuel management meter.....	40	Installing top cowling.....	58
Fuel flow meter.....	41	Power trim and tilt system.....	59
Fuel consumption meter / Fuel economy meter / Twin engine speed synchronizer.....	41	Battery.....	60
Water separator-alert indicator.....	43	Filling fuel.....	60
		Operating engine.....	61
		Sending fuel.....	61
		Starting engine.....	61
		Checks after starting engine.....	63
		Cooling water.....	63
		Warming up engine.....	64
		Procedure for warming up engine....	64
		Checks after engine warm up.....	64
		Shifting.....	64
		Stop switches.....	64

Table of contents

Shifting	64	Installing propeller	92
Stopping boat	65	Changing gear oil	93
Stopping engine.....	66	Inspecting and replacing anode(s) ...	94
Procedure.....	66	Checking battery (for electric start	
Trimming outboard motor.....	66	models)	95
Adjusting trim angle (Power trim		Connecting the battery.....	95
and tilt)	67	Disconnecting the battery	97
Adjusting boat trim.....	68		
Tilting up and down	68	Trouble Recovery.....	98
Procedure for tilting up (power trim		Troubleshooting.....	98
and tilt models)	69	Temporary action in	
Procedure for tilting down.....	70	emergency	101
Shallow water	71	Impact damage	101
Cruising in shallow water	71	Running single engine	
Cruising in other conditions	72	(twin engines).....	101
		Replacing fuse.....	102
Maintenance	73	Power trim and tilt will not	
Transporting and storing outboard		operate.....	102
motor.....	73	Hydraulic Steering system will not	
Storing outboard motor.....	73	operate.....	103
Conditioning and stabilizing		Water separator-alert is activated	
gasoline.....	73	after leaving port.....	103
Procedure.....	74	Treatment of submerged	
Lubrication	75	motor	105
Cleaning and anticorrosion			
measures	75	Consumer information	
Flushing cooling water passage.....	75	(For North America)	106
Cleaning the outboard motor	76	YAMAHA FOUR-STROKE	
Checking painted surface of		OUTBOARD MOTOR	
outboard motor.....	76	THREE-YEAR LIMITED	
Periodic maintenance	77	WARRANTY	106
Replacement parts	77	IMPORTANT WARRANTY	
Maintenance interval guidelines.....	77	INFORMATION IF YOU USE	
Maintenance chart 1	78	YOUR YAMAHA OUTSIDE	
Maintenance chart 2	81	THE U.S.A. OR CANADA.....	108
Greasing.....	82		
Inspecting spark plug.....	84	INDEX.....	109
Inspecting idle speed	85		
Changing engine oil.....	85		
Replacing the engine oil filter	90		
Why Yamalube	90		
Inspecting wiring and connectors....	91		
Inspecting propeller	91		
Removing propeller	92		

EMU33623

Outboard motor safety

Observe these precautions at all times.

EMU36502

Propeller

People can be injured or killed if they come in contact with the propeller. The propeller can keep moving even when the motor is in neutral, and sharp edges of the propeller can cut even when stationary.

- Stop the engine when a person is in the water near you.
- Keep people out of reach of the propeller, even when the engine is off.

EMU40272

Rotating parts

Hands, feet, hair, jewelry, clothing, personal flotation device (PFD) straps, etc., can become entangled with internal rotating parts of the engine, resulting in serious injury or death.

Keep the top cowling in place whenever possible. Do not remove or replace the top cowling with the engine running.

Only operate the engine with the top cowling removed according to the specific instructions in the manual. Keep hands, feet, hair, jewelry, clothing, PFD straps, etc., away from any exposed moving parts.

EMU33641

Hot parts

During and after operation, engine parts are hot enough to cause burns. Avoid touching any parts under the top cowling until the engine has cooled.

EMU33651

Electric shock

Do not touch any electrical parts while starting or operating the engine. They can cause shock or electrocution.

EMU33662

Power trim and tilt

Body parts can be crushed between the motor and the clamp bracket when the motor is trimmed or tilted. Keep body parts out of this area at all times. Be sure no one is in this area before operating the power trim and tilt mechanism.

The power trim and tilt switches operate even when the main switch is off. Keep people away from the switches whenever working around the motor.

Never get under the lower unit while it is tilted, even when the tilt support lever is locked. Severe injury could occur if the outboard motor accidentally falls.

EMU33672

Engine shut-off cord (lanyard)

Attach the engine shut-off cord so that the engine stops if the operator falls overboard or leaves the helm. This prevents the boat from running away under power and leaving people stranded, or running over people or objects.

Always attach the engine shut-off cord to a secure place on your clothing or your arm or leg while operating. Do not remove it to leave the helm while the boat is moving. Do not attach the cord to clothing that could tear loose, or route the cord where it could become entangled, preventing it from functioning.

Do not route the cord where it is likely to be accidentally pulled out. If the cord is pulled during operation, the engine will shut off and you will lose most steering control. The boat could slow rapidly, throwing people and objects forward.

Safety information

EMU33811

Gasoline

Gasoline and its vapors are highly flammable and explosive. Always, refuel according to the procedure on page 61 to reduce the risk of fire and explosion.

EMU33821

Gasoline exposure and spills

Take care not to spill gasoline. If gasoline spills, wipe it up immediately with dry rags. Dispose of rags properly.

If any gasoline spills onto your skin, immediately wash with soap and water. Change clothing if gasoline spills on it.

If you swallow gasoline, inhale a lot of gasoline vapor, or get gasoline in your eyes, get immediate medical attention. Never siphon fuel by mouth.

EMU33901

Carbon monoxide

This product emits exhaust gases which contain carbon monoxide, a colorless, odorless gas which may cause brain damage or death when inhaled. Symptoms include nausea, dizziness, and drowsiness. Keep cockpit and cabin areas well ventilated. Avoid blocking exhaust outlets.

EMU33781

Modifications

Do not attempt to modify this outboard motor. Modifications to your outboard motor may reduce safety and reliability, and render the outboard unsafe or illegal to use.

EMU33742

Boating safety

This section includes a few of the many important safety precautions that you should follow when boating.

EMU33711

Alcohol and drugs

Never operate after drinking alcohol or taking drugs. Intoxication is one of the most common factors contributing to boating fatalities.

EMU40281

Personal flotation devices (PFDs)

Have an approved PFD on board for every occupant. Yamaha recommends that you must wear a PFD whenever boating. At a minimum, children and non-swimmers should always wear PFDs, and everyone should wear PFDs when there are potentially hazardous boating conditions.

EMU33732

People in the water

Always watch carefully for people in the water, such as swimmers, skiers, or divers, whenever the engine is running. When someone is in the water near the boat, shift into neutral and stop the engine.

Stay away from swimming areas. Swimmers can be hard to see.

The propeller can keep moving even when the motor is in neutral. Stop the engine when a person is in the water near you.

EMU33752

Passengers

Consult your boat manufacturer's instructions for details about appropriate passenger locations in your boat and be sure all passengers are positioned properly before accelerating and when operating above an idle speed. Standing or sitting in non-designated locations may result in being thrown either overboard or within the boat due to waves, wakes, or sudden changes in speed or direction. Even when people are positioned prop-

erly, alert your passengers if you must make any unusual maneuver. Always avoid jumping waves or wakes.

EMU33763

Overloading

Do not overload the boat. Consult the boat capacity plate or boat manufacturer for maximum weight and number of passengers. Be sure that weight is properly distributed according to the boat manufacturer's instructions. Overloading or incorrect weight distribution can compromise the boat's handling and lead to an accident, capsizing or swamping.

EMU33773

Avoid collisions

Scan constantly for people, objects, and other boats. Be alert for conditions that limit your visibility or block your vision of others.

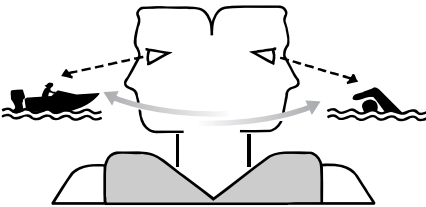

ZMU06025

Operate defensively at safe speeds and keep a safe distance away from people, objects, and other boats.

- Do not follow directly behind other boats or waterskiers.
- Avoid sharp turns or other maneuvers that make it hard for others to avoid you or understand where you are going.
- Avoid areas with submerged objects or shallow water.

- Ride within your limits and avoid aggressive maneuvers to reduce the risk of loss of control, ejection, and collision.
- Take early action to avoid collisions. Remember, boats do not have brakes, and stopping the engine or reducing throttle can reduce the ability to steer. If you are not sure that you can stop in time before hitting an obstacle, apply throttle and turn in another direction.

EMU48100

Collisions with floating or submerged objects

If the outboard motor hits a floating object or an obstacle in the water while cruising, the following could occur:

- The passengers and any loose equipment or luggage could be thrown forward due to the sudden deceleration.
- Parts of the outboard motor could come loose as a result of the impact and could be thrown into the boat.
- The boat or outboard motor could be damaged as a result of the impact.

When you operate the boat in an area where there might be floating objects or obstacles in the water, be sure to adjust the trim angle of the outboard motor, slow down, and operate carefully. For further information, see page 71.

If the outboard motor hits a floating object or an obstacle in the water, make sure that there are no abnormalities with the boat and the outboard motor. If anything abnormal is found, return to the nearest harbor at low speed and have a Yamaha dealer inspect the outboard motor.

Safety information

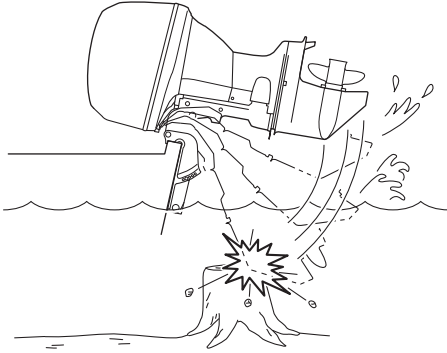

EMU33791

Weather

Stay informed about the weather. Check weather forecasts before boating. Avoid boating in hazardous weather.

EMU44161

Accident reporting

Boat operators are required by law to file a Boating Accident Report with their boating law enforcement agency if their boat is involved in any of the following accidents:

- (1) There is loss of life or probable loss of life.
- (2) There is personal injury that requires medical attention beyond first aid.
- (3) There is property damage to boats or other property over a certain amount.
- (4) There is complete loss of a boat.

Contact local law enforcement personnel if a report is necessary.

EMU44173

Boat education and training For U.S.A.

Operators should take a boating safety course. This may be required in your state. Many of the organizations listed in the next section can provide information about courses in your area.

You may also want to consider an Internet-based program for basic boater education. The Online Boating Safety Course provided by the Boat U.S. Foundation, is approved by the National Association of State Boating Law Administrators (NASBLA) and recognized by the United States Coast Guard. Most, but not all, states accept this course to meet their minimum requirements. While it cannot replace an in-depth course such as one offered by the U.S. Coast Guard, U.S. Power Squadron, or other organization, this online course does provide a general overview of the basics in boating safety, requirements, navigation, and operation. Upon successful completion of the course, the user can download a certificate of completion immediately or, for a small charge, request one by mail. To take this free course, go to boat-us.org.

For Canada

All operators of pleasure craft must illustrate competency by means of a Pleasure Craft Operators Card with the exception of Personal Water Craft used for rental purposes which require a rental checklist be completed. Pleasure Craft Operators Cards can be obtained following the completion of a competency course, with an online option. Details can be found on Transport Canada's website. www.tc.gc.ca

EMU33881

Passenger training

Make sure at least one other passenger is trained to operate the boat in the event of an emergency.

EMU33891

Boating safety publications

Be informed about boating safety. Additional publications and information can be obtained from many boating organizations.

EMU33592

Laws and regulations

Know the marine laws and regulations where you will be boating—and obey them. Several sets of rules prevail according to geographic location, but all are basically the same as the International Rules of the Road. The rules presented in the following section are condensed—and have been provided for your convenience only.

Contact the U.S. Coast Guard, the National Association of State Boating Law Administrators, or your local Power Squadron for a complete set of rules governing the waters in which you will be using your boat.

EMU44742

Boating organizations

The following organizations provide boating safety training and information about boating safety and laws.

In the U.S.A.**United States Coast Guard**

Consumer Affairs Staff (G-BC)
Office of Boating, Public, and Consumer Affairs

U.S. Coast Guard Headquarters
Washington, D.C. 20593-0001
<https://www.uscgboating.org/>

United States Power Squadrons

1-888-FOR-USPS (1-888-367-8777)
<https://www.usps.org/>

Boat Owners Association of The United States

1-800-336-BOAT (1-800-336-2628)
<https://www.boatus.com/>

National Association of State Boating Law Administrators (NASBLA)

1500 Leestown Road, Suite 330
Lexington, KY 40511 859-225-9497
<https://www.nasbla.org/>

National Marine Manufacturers Association (NMMA)

200 East Randolph Drive
Suite 5100
Chicago, IL 60601
<https://www.nmma.org/>

Marine Retailers Association of America

155 N. Michigan Ave.
Chicago, IL 60304
<https://www.mraa.com/>

In Canada**National Marine Manufacturers Association Canada**

14 McEwan Drive
Suite 8
Bolton, ON
L7E 1H1
<https://www.nmma.ca/>

In Australia**Boating Industry Association of Australia**

<https://www.bia.org.au/>

Safety information

In New Zealand
NZ Marine Industry Association
<https://www.nzmarine.com/>

EMU33692

Basic boating rules (Rules of the road)

Just as there are rules that apply when you are driving on streets and highways, there are waterway rules that apply when you are driving your boat. These rules are used internationally. (For U.S.A.: and are also enforced by the United States Coast Guard and local agencies.) You should be aware of these rules, and follow them whenever you encounter another vessel on the water.

EMU33702

Steering and sailing rules and sound signals

Whenever two vessels on the water meet one another, one vessel has the right-of-way; it is called the “stand-on” vessel. The vessel that does not have the right-of-way is called the “give-way” or “burdened” vessel. These rules determine which vessel has the right-of-way, and what each vessel should do.

Stand-on vessel

The vessel with the right-of-way has the duty to continue its course and speed, except to avoid an immediate collision. When you maintain your direction and speed, the other vessel will be able to determine how best to avoid you.

Give-way vessel

The vessel that does not have the right-of-way has the duty to take positive and timely action to stay out of the way of the Stand-On vessel. Normally, you should not cross in front of the vessel with the right-of-way. You

should slow down or change directions briefly and pass behind the other vessel. You should always move in such a way that the operator of the other vessel can see what you are doing.

“The general prudential rule”

This rule is called Rule 2 in the International Rules and says,

“In obeying and construing these rules due regard shall be had to all dangers of navigation and collision, and to any special circumstances, which may render a departure from the above rules necessary in order to avoid immediate danger.”

In other words, follow the standard rules except when a collision will occur unless both vessels try to avoid each other. If that is the case, both vessels become “Give-Way” vessels.

EMU25524

Rules when encountering vessels

There are three main situations that you may encounter with other vessels which could lead to a collision unless the Steering Rules are followed:

Meeting: (you are approaching another vessel head-on)

Crossing: (you are traveling across the other vessel’s path)

Overtaking: (you are passing or being passed by another vessel)

In the following illustration, your boat is in the center. You should give the right-of-way to any vessels shown in white area (you are the Give-Way vessel). Any vessels in the shaded area must yield to you (they are the Give-Way vessels). Both you and the meeting vessel must alter course to avoid each other.

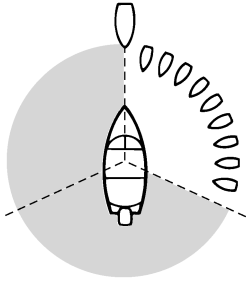

ZMU01705

Meeting

If you are meeting another power vessel head-on, and are close enough to run the risk of collision, neither of you has the right-of-way. Both of you should alter course to avoid an accident. You should keep the other vessel on your port (left) side. This rule doesn't apply if both of you will clear one another if you continue on your set course and speed.

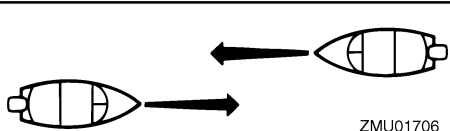
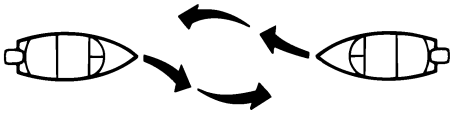

ZMU01706

Crossing

When two power driven vessels are crossing each other's path close enough to run the risk of collision, the vessel which has the other on the starboard (right) side must keep out of the way of the other. If the other vessel is on your right, you must keep out of its way; you are the Give-Way vessel. If the other vessel is on your port (left) side, remember that you should maintain course and direction, provided the other vessel gives you the right-of-way as it should.

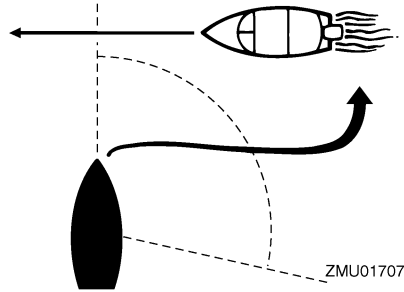

ZMU01707

Overtaking

If you are passing another vessel, you are the "Give-Way" vessel. This means that the other vessel is expected to maintain its course and speed. You must stay out of its way until you are clear of it. Likewise, if another vessel is passing you, you should maintain your speed and direction so that the other vessel can steer itself around you.

EMU25532

Other special situations

There are three other rules you should be aware of when driving your boat around other vessels.

Narrow channels and bends

When navigating in narrow channels, you should keep to the right when it is safe and practical to do so. If the operator of a power-driven vessel is preparing to go around a bend that may obstruct the view of other water vessels, the operator should sound a prolonged blast on the whistle (4 to 6 seconds). If another vessel is around the bend, it too should sound the whistle. Even if no reply is heard, however, the vessel should still proceed around the bend with caution. If you navigate such waters with your boat, you will need to carry a portable air horn, available from local marine supply stores.

Safety information

Fishing vessel right-of-way

All vessels that are fishing with nets, lines or trawls are considered to be “fishing vessels” under the International Rules. Vessels with trolling lines are not considered fishing vessels. Fishing vessels have the right-of-way regardless of position. Fishing vessels cannot, however, impede the passage of other vessels in narrow channels.

Sailing vessel right-of-way

Sailing vessels should normally be given the right-of-way. The exceptions to this are:

- (1) When the sailing vessel is overtaking the power-driven vessel, the power-driven vessel has the right-of-way.
- (2) Sailing vessels should keep clear of any fishing vessel.
- (3) In a narrow channel, a sailing vessel should not hamper the safe passage of a power-driven vessel that can navigate only in such a channel.

Reading buoys and other markers

The waters of the United States are marked for safe navigation by the lateral system of buoyage. Simply put, buoys and markers have an arrangement of shapes, colors, numbers and lights to show which side of the buoy a boater should pass on when navigating in a particular direction. The markings on these buoys are oriented from the perspective of being entered from seaward (the boater is going towards the port). This means that red buoys are passed on the starboard (right) side when proceeding from open water into port, and black buoys are to port (left) side. When navigating out of port, your position with respect to the buoys should be reversed; red buoys should be to port and black buoys to starboard.

Many bodies of water used by boaters are entirely within the boundaries of a particular state. The Uniform State Waterway Marking System has been devised for these waters. This system uses buoys and signs with distinctive shapes and colors to show regulatory or advisory information. These markers are white with black letters and orange boarders. They signify speed zones, restricted areas, danger areas, and general information.

Remember, markings may vary by geographic location. Always consult local boating authorities before driving your boat in unfamiliar waters.

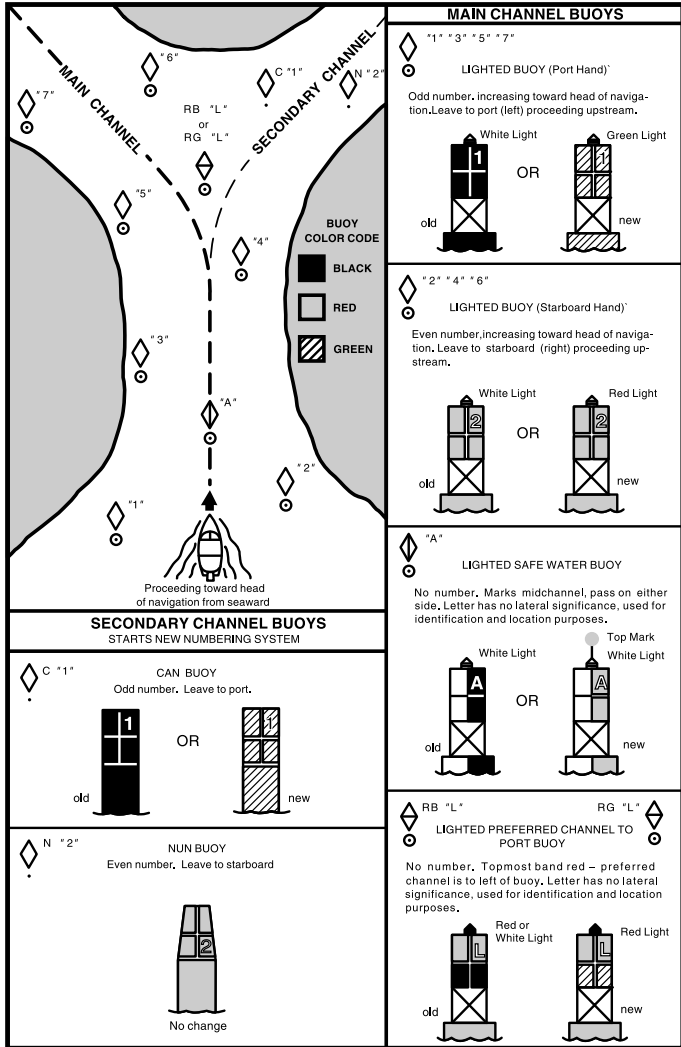

ZMU01708

General information

EMU25172

Identification numbers record

EMU25186

Outboard motor serial number

The outboard motor serial number is stamped on the label attached to the port side of the clamp bracket.

Record your outboard motor serial number in the spaces provided to assist you in ordering spare parts from your Yamaha dealer or for reference in case your outboard motor is stolen.

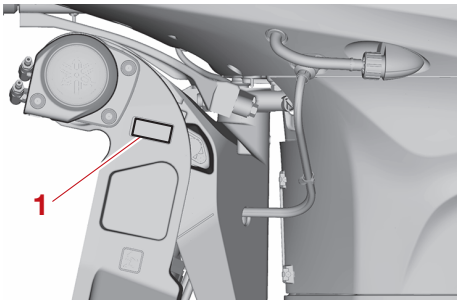

1. Outboard motor serial number location

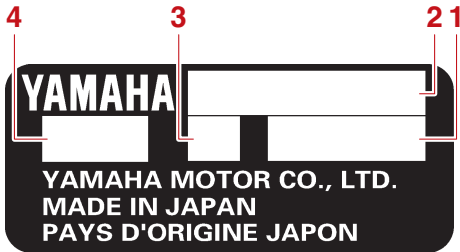

ZMU01692

1. Serial number
2. Model name
3. Motor transom height
4. Engine code

EMU25192

Key number

If a main key switch is equipped with the motor, the key identification number is stamped on your key as shown in the illustration. Record this number in the space provided for reference in case you need a new key.



ZMU01693

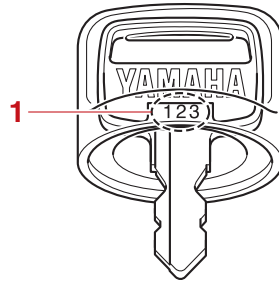

ZMU01694

1. Key number

EMU38984

EC Declaration of Conformity (DoC)

This declaration is included with outboard motors that conform to European regulations.

This outboard motor conforms to certain portions of the European Parliament directive relating to machinery.

Each conformed outboard motor accompanied with EC DoC. EC DoC contains the following information;

- Manufacturer
- Model name
- Engine code
- Applied directives

EMU48442

CE Marking / UKCA Marking

This label is affixed to outboard motors that conform to European regulations.

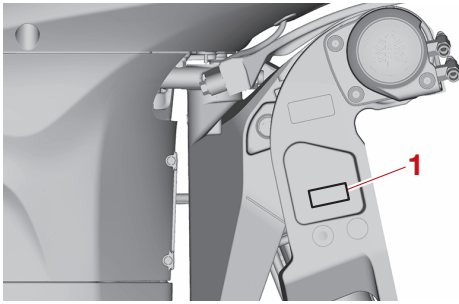

1. CE marking location

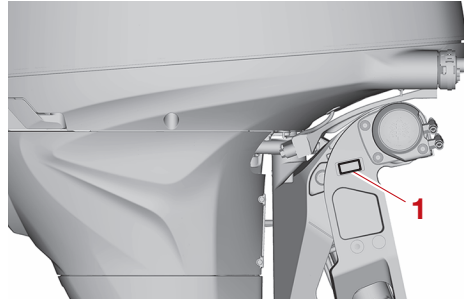

1. Compliance mark label location



CE marking

Outboard motors affixed with this “CE” marking conform with the directives of; 2006/42/EC, 2014/30/EU, and 2013/53/EU.

UKCA marking

This product is in compliance with the Recreational Craft Regulations 2017, Electromagnetic Compatibility Regulations 2016 and Supply of Machinery (Safety) Regulations 2008.

EMU46133

Compliance mark label

Engines affixed with this label conform to the regulations for each country.

This label is affixed to the clamp bracket or swivel bracket.

Regulatory Compliance Mark (RCM)

Engines affixed with this mark conform to certain portion(s) of the Australian Radio Communications Act.

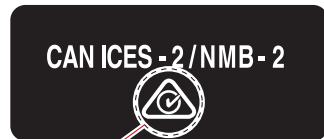

1

ZMU08190

1. Regulatory Compliance Mark (RCM)

ICES-002 Compliance Label

Engines affixed with this mark meet all requirements of the Canadian Interference Causing Equipment Regulations.

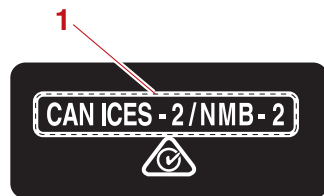

1

ZMU08191

1. ICES-002 Compliance Label

General information

EMU33524

Read manuals and labels

Before operating or working on this outboard motor:

- Read this manual.
- Read any manuals supplied with the boat.
- Read all labels on the outboard motor and the boat.

If you need any additional information, contact your Yamaha dealer.

EMU33836

Warning labels

If these labels are damaged or missing, contact your Yamaha dealer for replacements.

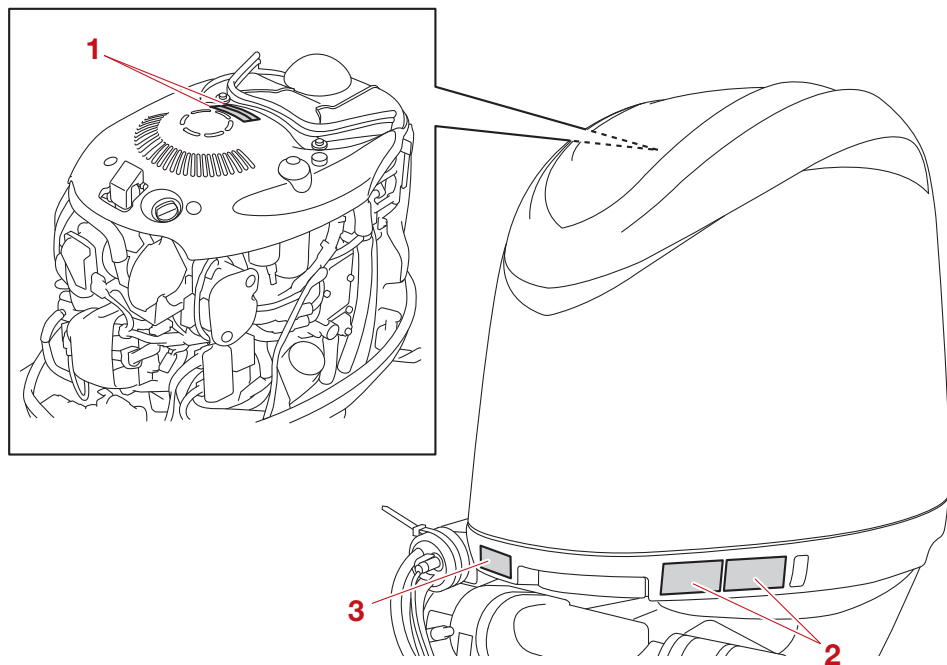

1



2

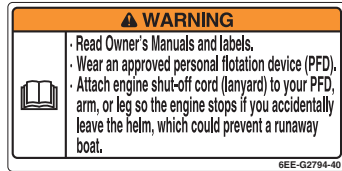

EMU34652

Contents of labels

The above warning labels mean as follows.

1

EWM01682



- Keep hands, hair, and clothing away from rotating parts while the engine is running.
- Do not touch or remove electrical parts when starting or during operation.

2

EWM01672



- Read Owner's Manuals and labels.
- Wear an approved personal flotation device (PFD).

- Attach engine shut-off cord (lanyard) to your PFD, arm, or leg so the engine stops if you accidentally leave the helm, which could prevent a runaway boat.

EMU33851

Other labels

3



General information

EMU35133

Symbols

The following symbols mean as follows.

Notice/Warning



ZMU05696

Read Owner's Manual



ZMU05664

Hazard caused by continuous rotation



ZMU05665

Electrical hazard



ZMU05666

EMU48010

Engine data recording

This model's ECM stores certain engine data to assist in the diagnosis of malfunctions and for research, statistical analysis and development purposes.

Although the sensors and recorded data will vary by model, the main data points are:

- Engine status and engine performance data

This data will be uploaded only when a special Yamaha diagnostic tool is attached to the engine, such as when maintenance checks or service procedures are performed.

Yamaha will not disclose this data to a third party except in the following cases. In addition, Yamaha may provide engine data to a contractor in order to outsource services related to the handling of the engine data. Even in this case, Yamaha will require the contractor to properly handle the engine data we provided and Yamaha will appropriately manage the data.

- With the consent of the boat owner
- Where obligated by law
- For use by Yamaha in litigation
- For general Yamaha-conducted research purposes when the data is not related to an individual engine or owner

Specifications and requirements

EMU40501

Specifications

TIP:

“(SUS)” indicates that the specification is for the outboard motor when it is equipped with a stainless steel propeller.

EMU48361

Dimension and weight:

Overall length:

963 mm (37.9 in)

Overall width:

548 mm (21.6 in)

Overall height L:

1742 mm (68.6 in) (F200C)

Overall height X:

1869 mm (73.6 in)

Motor transom height L:

516 mm (20.3 in) (F200C)

Motor transom height X:

642 mm (25.3 in)

Dry weight (SUS) L:

240 kg (529 lb) (F200C)

Dry weight (SUS) X:

240 kg (529 lb) (F175B)

241 kg (531 lb) (F200C, LF200C)

Performance:

Full throttle operating range:

5000–6000 r/min

Rated power:

128.7 kW (175 HP) (F175B)

147.1 kW (200 HP) (F200C, LF200C)

Idle speed (in neutral):

650–750 r/min

Power unit:

Type:

4-stroke DOHC L4 16 valves

Total displacement:

2785 cm³ (169.9 c.i.)

Bore × stroke:

96.0 × 96.2 mm (3.78 × 3.79 in)

Ignition system:

TCI

Spark plug (NGK):

LFR6A-11

Spark plug gap:

1.0–1.1 mm (0.039–0.043 in)

Steering system:

Remote steering

Starting system:

Electric starter

Starting carburetion system:

Fuel injection

Valve clearance IN (cold engine):

0.17–0.24 mm (0.0067–0.0094 in)

Valve clearance EX (cold engine):

0.31–0.38 mm (0.0122–0.0150 in)

Battery rating (CCA/SAE):

680–1150 A

Battery rating (MCA/ABYC):

770–1370 A

Battery rating (RC/SAE):

160 minutes

Battery rating (CCA/EN):

640–1080 A

Battery rating (20HR/IEC):

80 Ah

Maximum generator output:

50 A

Lower unit:

Gear shift positions:

Forward-neutral-reverse

Gear ratio:

1.86 (26/14)

Trim and tilt system:

Power trim and tilt

Propeller mark:

M (F175B, F200C)

ML (LF200C)

Specifications and requirements

Fuel and oil:

Recommended fuel:

Mid-grade unleaded gasoline (For North America), Premium unleaded gasoline (F200C, LF200C)

Regular unleaded gasoline (F175B)

Min. pump octane number (PON):

86 (F175B)

89 (F200C, LF200C)

Min. research octane number (RON):

90 (F175B)

94 (F200C, LF200C)

Recommended engine oil:

YAMALUBE 4M FC-W or 4-stroke outboard motor oil



Recommended engine oil grade 1:

SAE 10W-30/10W-40/5W-30

API SG/SH/SJ/SL

Engine oil quantity (without oil filter replacement):

4.3 L (4.55 US qt, 3.78 Imp.qt)

Engine oil quantity (with oil filter replacement):

4.5 L (4.76 US qt, 3.96 Imp.qt)

Lubrication system:

Wet sump

Recommended gear oil:

Yamalube Marine Gearcase Lube HD or Hypoid gear oil

Recommended gear oil grade:

SAE 90 API GL-4 / SAE 80W API GL-5 /

SAE 90 API GL-5

Gear oil quantity:

0.980 L (1.036 US qt, 0.862 Imp.qt)

Recommended hydraulic steering fluid 1:

Fluid recommended by hydraulic steering helm manufacturer

EMU33556

Installation requirements

EMU33566

Boat horsepower rating

EWM01561



Overpowering a boat can cause severe instability.

Before installing the outboard motor(s), confirm that the total horsepower of your outboard motor(s) does not exceed the boat's maximum horsepower rating. See the boat's capacity plate or contact the manufacturer.

EMU40491

Mounting outboard motor

EWM02501



- **Improper mounting of the outboard motor could result in hazardous conditions such as poor handling, loss of control, or fire hazards.**
- **Because the outboard motor is very heavy, special equipment and training is required to mount it safely.**

Your dealer or other person experienced in proper rigging should mount the outboard motor using correct equipment and complete rigging instructions. For further information, see page 53.

EMU33582

Remote control requirements

EWM01581



- **If the engine starts in gear, the boat can move suddenly and unexpectedly, possibly causing a collision or throwing passengers overboard.**

Specifications and requirements

- If the engine ever starts in gear, the start-in-gear protection device is not working correctly and you should discontinue using the outboard. Contact your Yamaha dealer.

The remote control unit must be equipped with a start-in-gear protection device(s). This device prevents the engine from starting unless it is in neutral.

EMU25695

Battery requirements

EMU44724

Battery specifications

Standard lead-acid, AGM, gel-cell, and maintenance-free batteries are permitted. Use a fully charged battery that meets the following specifications. The battery is an important component necessary to obtain sure engine starting and to maintain engine performance. The engine may not start if the battery voltage is too low.

For North America

It is necessary to meet only two of the three specifications (CCA, MCA, and RC) in one of the following combinations:

- CCA/SAE and RC
- MCA/ABYC and RC

Battery rating (CCA/SAE):

680–1150 A

Battery rating (MCA/ABYC):

770–1370 A

Battery rating (RC/SAE):

160 minutes

For Oceania

It is necessary to meet the following specifications.

Battery rating (CCA/EN):

640–1080 A

Battery rating (20HR/IEC):

80 Ah

ECM01064

NOTICE

- Do not use a battery that does not meet the specified capacity. If a battery that does not meet specifications is used, the electric system could perform poorly or be overloaded, causing electric system damage.
- Do not use a battery which exceeds the maximum CCA rating. If the batteries are used in parallel circuit, use new batteries of the same type and make sure that the total battery rating never exceeds the maximum CCA rating.

EMU36293

Mounting battery

Mount the battery holder securely in a dry, well-ventilated, vibration-free location in the boat. **WARNING! Do not put flammable items, or loose heavy or metal objects in the same compartment as the battery. Fire, explosion or sparks could result.**

[EWM01821]

Battery cable

The battery cable size and length are critical. Consult your Yamaha dealer about the battery cable size and length.

EMU36303

Multiple batteries

To connect multiple batteries, such as for multiple engine configurations or for an accessory battery, consult your Yamaha dealer about battery selection and correct wiring.

Battery isolator

Your outboard motor is capable of charging an accessory battery separate from the starting battery using an optional isolator lead.

Specifications and requirements

Contact your Yamaha dealer for installation of an optional isolator lead with over-current protection.

EMU41604

Propeller selection

Next to selecting an outboard motor, selecting the right propeller is one of the most important purchasing decisions a boater can make. The type, size, and design of your propeller have a direct impact on acceleration, top speed, fuel economy, and even engine life. Yamaha designs and manufactures propellers for every Yamaha outboard motor and every application.

Your Yamaha dealer can help you select the right propeller for your boating needs. Select a propeller that will allow the engine to reach the middle or upper half of the operating range at full throttle with the maximum boatload. Generally, select a larger pitch propeller for a smaller operating load and a smaller pitch propeller for a heavier load. If you carry loads that vary widely, select the propeller that lets the engine run in the proper range for your maximum load but remember that you may need to reduce your throttle setting to stay within the recommended engine speed range when carrying lighter loads.

Yamaha recommends to use a propeller suitable for the "Shift Dampener System (SDS)". For further information, consult your Yamaha dealer.

To check the propeller, see page 91.

Propeller example

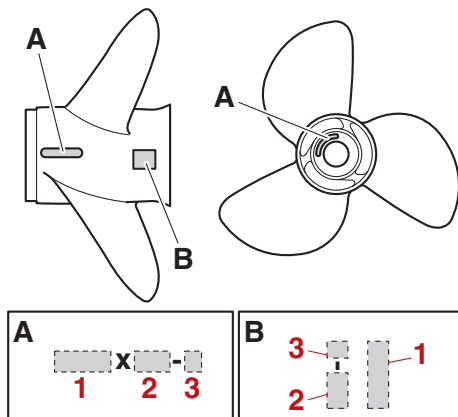

1. Propeller diameter in inches
2. Propeller pitch in inches
3. Type of propeller (propeller mark)

EMU36313

Counter rotation models

Standard outboard motors rotate clockwise. Counter rotation models rotate counterclockwise and are typically used in multiple motor setups.

On counter rotation models, be sure to use a propeller intended for counterclockwise rotation. These propellers are identified with the letter "L" after the size indication on the propeller. **WARNING! Never use a standard propeller with a counter rotation motor, or a counter rotation propeller with a standard motor. Otherwise the boat could go in the direction opposite of that expected (for example, reverse instead of forward), which could lead to an accident.** [EWM01811]

For instructions on propeller removal and installation, see page 92.

EMU25771

Start-in-gear protection

Yamaha outboard motors or Yamaha-approved remote control units are equipped with start-in-gear protection device(s). This

Specifications and requirements

feature permits the engine to be started only when it is in neutral. Always select neutral before starting the engine.

EMU41953

Engine oil requirements

Select an oil grade according to the average temperatures in the area where the outboard motor will be used.

Recommended engine oil:

YAMALUBE 4M FC-W or 4-stroke outboard motor oil

Recommended engine oil grade 1:

SAE 10W-30/10W-40/5W-30
API SG/SH/SJ/SL

Recommended engine oil grade 2:

SAE 15W-40/20W-40/20W-50
API SH/SJ/SL

Engine oil quantity (without oil filter replacement):

4.3 L (4.55 US qt, 3.78 Imp.qt)

Engine oil quantity (with oil filter replacement):

4.5 L (4.76 US qt, 3.96 Imp.qt)

If oil grades listed under Recommended engine oil grade 1 are not available, select an alternative oil grade listed under Recommended engine oil grade 2.

Recommended engine oil grade 1

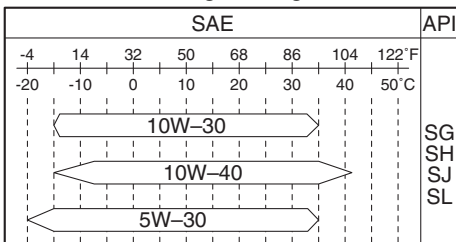

ZMU08143

Recommended engine oil grade 2

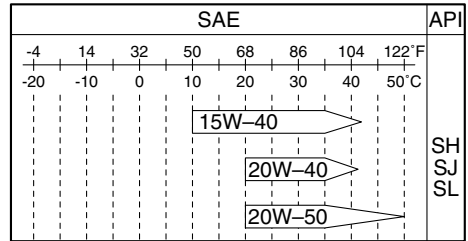

ZMU06855

EMU49540

Hydraulic steering fluid requirements

For the hydraulic steering fluid, use the following recommended fluids.

Recommended hydraulic steering fluid 1:

Fluid recommended by hydraulic steering helm manufacturer

Recommended hydraulic steering fluid 2:

Fluid equivalent to ISO VG15

If the fluid listed in Recommended hydraulic steering fluid 1 is not available, use the fluid listed in Recommended hydraulic steering fluid 2.

EMU36361

Fuel requirements

EMU44792

Gasoline

Use a good quality gasoline that meets the minimum octane rating. If knocking or ping-ing occurs, use a different brand of gasoline or premium unleaded fuel.

Yamaha recommends that you use alcohol-free gasoline (see Gasoline with Ethanol) whenever possible.

The use of a poor quality gasoline may result in starting and running problems. If you encounter drivability problems, which you sus-

Specifications and requirements

pect could be related to the fuel you are using, Yamaha recommends that you switch to a recognized high quality brand of gasoline, such as a gasoline that is advertised as Top Tier Detergent Gasoline. (North America only) **NOTICE: Failure to comply with these recommendations may also result in unscheduled maintenance, fuel system damage, and internal engine damage.** [ECM04480]

For North America

Recommended fuel:

Mid-grade unleaded gasoline (F200C, LF200C)

Regular unleaded gasoline (F175B)

Min. pump octane number (PON):

86 (F175B)

89 (F200C, LF200C)

For Oceania

Recommended fuel:

Premium unleaded gasoline (F200C, LF200C)

Regular unleaded gasoline (F175B)

Min. research octane number (RON):

90 (F175B)

94 (F200C, LF200C)

ECM01982

NOTICE

- **Do not use leaded gasoline. Leaded gasoline can seriously damage the engine.**
- **Avoid getting water and contaminants in the fuel tank. Contaminated fuel can cause poor performance or engine damage. Use only fresh gasoline that has been stored in clean containers.**

Gasoline with Ethanol

Two types of gasoline are commonly available in the U.S.A., Canada, Australia and New Zealand for use in automobiles and boats: conventional gasoline without Ethanol

and gasoline with Ethanol, which is typically referred to as E10 gasoline. According to federal regulations, E10 gasoline may contain up to 10% Ethanol.

A high quality gasoline without Ethanol is the preferred fuel for your Yamaha outboard motor. However, if gasoline with Ethanol is the only fuel available in your area, your Yamaha outboard motor is calibrated to run properly on fresh E10 gasoline that meets the minimum octane requirement specified for this model.

ECM02402

NOTICE

Never use a gasoline for your outboard motor that contains more than 10% Ethanol, such as E15 which contains 15% Ethanol or E85 which contains 85% Ethanol, or gasoline containing any amount of Methanol. These fuels can cause starting and running problems, as well as serious fuel system and internal engine damage.

Gasoline containing ethanol has several properties that may cause boat fuel system problems.

- Ethanol is a strong solvent (cleaning agent) that can clean gum and varnish deposits from a boat's fuel system, particularly in older boats, as well as tanks and pipes used in gasoline distribution. These released deposits contaminate the fuel and can cause problems, such as clogged fuel filters, carburetors, or fuel injectors, which could result in engine damage.
- Ethanol may dissolve resins used in the construction of fiberglass fuel tanks. The dissolved resins contaminate the fuel and can cause problems, such as clogged fuel filters, carburetors, or fuel injectors, which could result in engine damage.

Specifications and requirements

- Ethanol is hygroscopic (has a strong attraction to water). Therefore, any water that inadvertently enters the fuel system, including moisture that is absorbed from the air, will mix with the ethanol in the gasoline. If the amount of water is excessive, the ethanol and water mixture will separate from the gasoline in a layer at the bottom of the fuel tank. This ethanol and water mixture is very corrosive to aluminum fuel tanks and fuel system components.
- The usable life span of E10 gasoline may be shorter than the normal length of off-season boat storage, causing starting and running problems related to stale fuel.

For more information on using fuel containing ethanol, visit: <http://www.yamaha-motor.com>

Gasoline Filtration

Yamaha outboard motors are equipped with internal fuel filters. However, excessive water or debris entering your engine's fuel system could prematurely clog the internal filters, causing starting and running problems, fuel system damage, and internal engine damage. Therefore, it is recommended that an external 10-micron water-separating fuel filter be installed on your boat and serviced frequently. Consult your authorized Yamaha dealer for a 10-micron filter that meets your engine's requirements.

EMU41342

Gasoline Additives

Gasoline blends change to meet automobile emission regulations and economic conditions. Additives, added by gasoline distributors, necessary for proper automobile engine operation and durability, may not be sufficient for typical boat applications. Intake valve and combustion chamber deposits may accumulate in boat engines more rapidly than encountered in automotive use. In addition,

gasoline used for boating will typically age longer between refills than gasoline used in automobiles, resulting in stale and unusable gasoline that may cause starting and running problems, fuel system damage, and internal engine damage.

Yamaha recommends the use of two Yamalube gasoline additives to reduce internal deposits and extend the storage life of gasoline. Continuous use of Yamalube Ring Free Fuel Additive Plus reduces harmful internal deposits. Yamalube Fuel Stabilizer & Conditioner Plus added to fresh gasoline will help protect the fuel system from varnishing while helping to keep the gasoline's octane level from decreasing excessively during storage. Other additives may also be available on the market that may have varying degrees of effectiveness. Consult your Yamaha dealer concerning what may work best for the locally available gasoline and environmental conditions.

EMU36881

Muddy or acidic water

Yamaha strongly recommends that you have your dealer install the optional chromium-plated water pump kit if you use the outboard motor in muddy or acidic water conditions. However, depending on the model it might not be required.

EMU41354

Anti-fouling paint

A clean hull is required to maintain your boat's performance. Boats moored in the water should be protected from marine growth (barnacles, mussels, and marine plants). If approved by regulations for your area, the bottom of the hull can be coated with an anti-fouling paint to inhibit marine growth.

Anti-fouling paints specifically formulated for use on aluminum may be applied to the outboard motor. The original Yamaha paint sur-

Specifications and requirements

face may be scuffed lightly before applying anti-fouling paint, but do not remove the original paint. Removal of the original paint will increase the rate of corrosion.

ECM04821

NOTICE

- **Anti-fouling paint for fiberglass and wood may contain materials, such as copper, graphite, and tin, that can cause corrosion if applied to aluminum boats and outboard motor components. Never apply these types of paint to your outboard motor because rapid corrosion damage could occur.**
 - **Anti-fouling paint can increase drag (friction) between the boat and the water, and possibly affect performance. If the effects are too great, reducing propeller pitch may be necessary.**
-

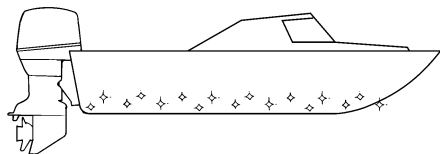

ZMU05176

Sacrificial anodes are attached to the outboard motor to provide corrosion protection and must never be painted.

Sacrificial anodes made from a different material may be necessary for maximum corrosion protection due to your local water conditions. Please consult your Yamaha dealer.

ECM02421

NOTICE

Painted sacrificial anodes will not provide corrosion protection.

EMU40302

Outboard motor disposal requirements

Never illegally discard (dump) the outboard motor. Yamaha recommends consulting the dealer about discarding the outboard motor.

EMU36353

Emergency equipment

Keep the following items onboard in case there is trouble with the outboard motor.

- A tool kit with assorted screwdrivers, pliers, wrenches (including metric sizes), and electrical tape.
- Waterproof flashlight with extra batteries.
- An extra engine shut-off cord (lanyard) with clip.
- Spare parts, such as an extra set of spark plugs.

Consult your Yamaha dealer for details.

EMU25223

Emission control information

EMU25232

This engine conforms to U.S. Environmental Protection Agency (EPA) regulations for marine SI engines. See the label affixed to your engine for details.

EMU31563

Approval label of emission control certificate

This label is attached at the location shown. New Technology; (4-stroke) MFI

Specifications and requirements

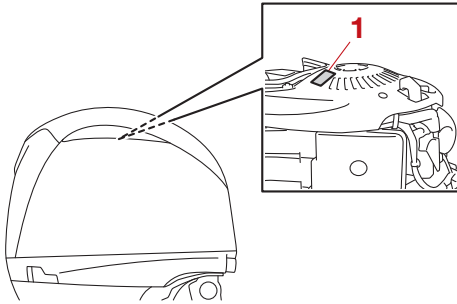

1. Approval label location

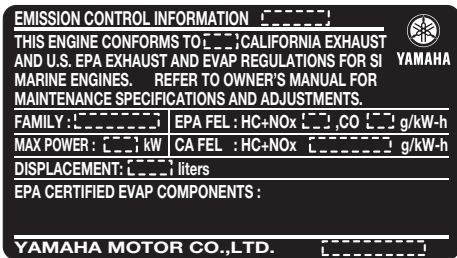

EMU25275

Star labels

Your outboard motor is labeled with a California Air Resources Board (CARB) star label. See below for a description of your particular label.

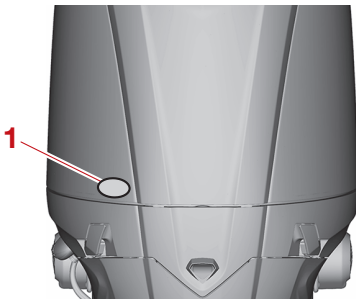

1. Star label location

EMU40331

One Star—Low Emission

The one-star label identifies engines that meet the Air Resources Board's Personal Watercraft and Outboard marine engine 2001 exhaust emission standards. Engines meeting these standards have 75% lower emissions than conventional carbureted two-stroke engines. These engines are equivalent to the U.S. EPA's 2006 standards for marine engines.



ZMU01702

EMU40341

Two Stars—Very Low Emission

The two-star label identifies engines that meet the Air Resources Board's Personal Watercraft and Outboard marine engine 2004 exhaust emission standards. Engines meeting these standards have 20% lower emissions than One Star-Low-Emission engines.



ZMU01703

Specifications and requirements

EMU40351

Three Stars—Ultra Low Emission

The three-star label identifies engines that meet the Air Resources Board's Personal Watercraft and Outboard marine engine 2008 exhaust emission standards or the Sterndrive and Inboard marine engine 2003-2008 exhaust emission standards. Engines meeting these standards have 65% lower emissions than One Star-Low-Emission engines.



ZMU01704

EMU33862

Four Stars—Super Ultra Low Emission

The four-star label identifies engines that meet the Air Resources Board's Sterndrive and Inboard marine engine 2009 exhaust emission standards. Personal Watercraft and Outboard marine engines may also comply with these standards. Engines meeting these standards have 90% lower emissions than One Star-Low-Emission engines.



ZMU05663

EMU46722

Components diagram

TIP:

* May not be exactly as shown; also may not be included as standard equipment on all models (order from dealer).

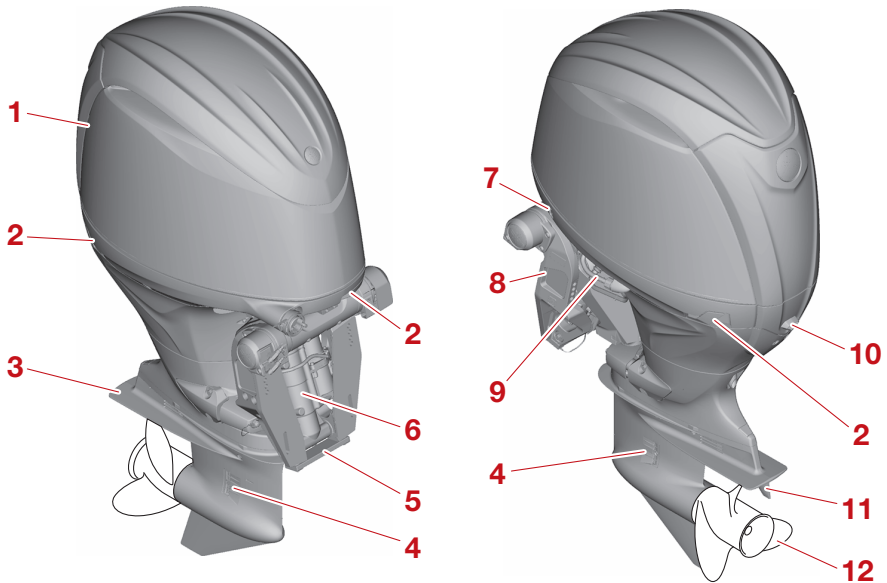

1. Top cowling
2. Cowling lock lever
3. Anti-cavitation plate
4. Cooling water inlet
5. Anode
6. Power trim and tilt unit
7. Power trim and tilt switch
8. Clamp bracket
9. Flushing device
10. Idle hole
11. Trim tab (anode)
12. Propeller*

Components

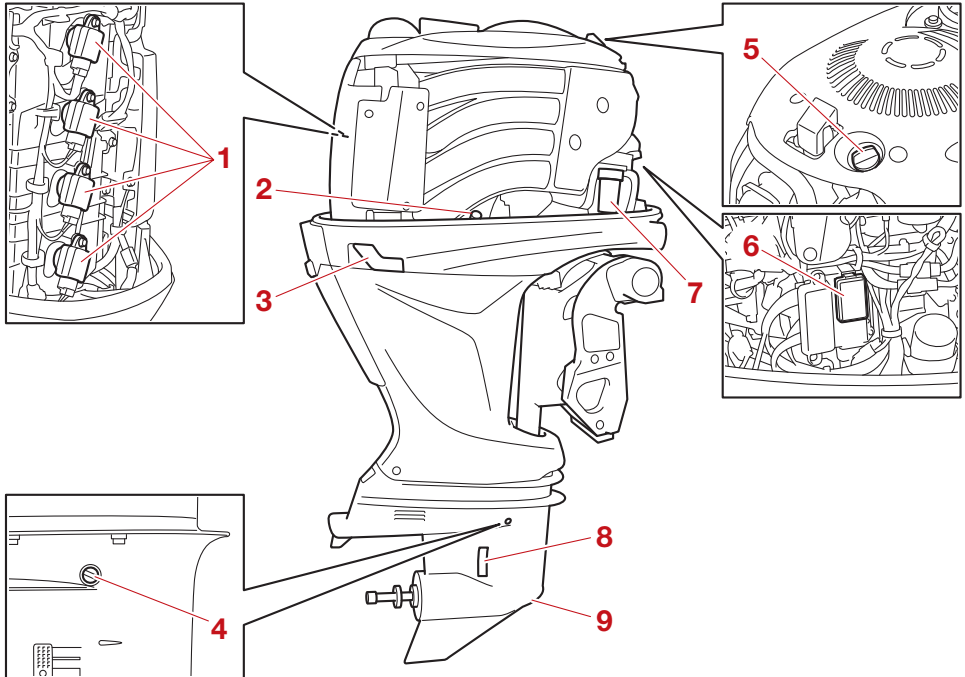

1. Ignition coil
2. Oil dipstick
3. Cowling lock lever
4. Oil level plug
5. Oil filler cap
6. Fuse box
7. Fuel filter
8. Cooling water inlet
9. Gear oil drain screw

EMU46733

Optional items

The following items are available from your Yamaha dealer. For details, consult your Yamaha dealer.

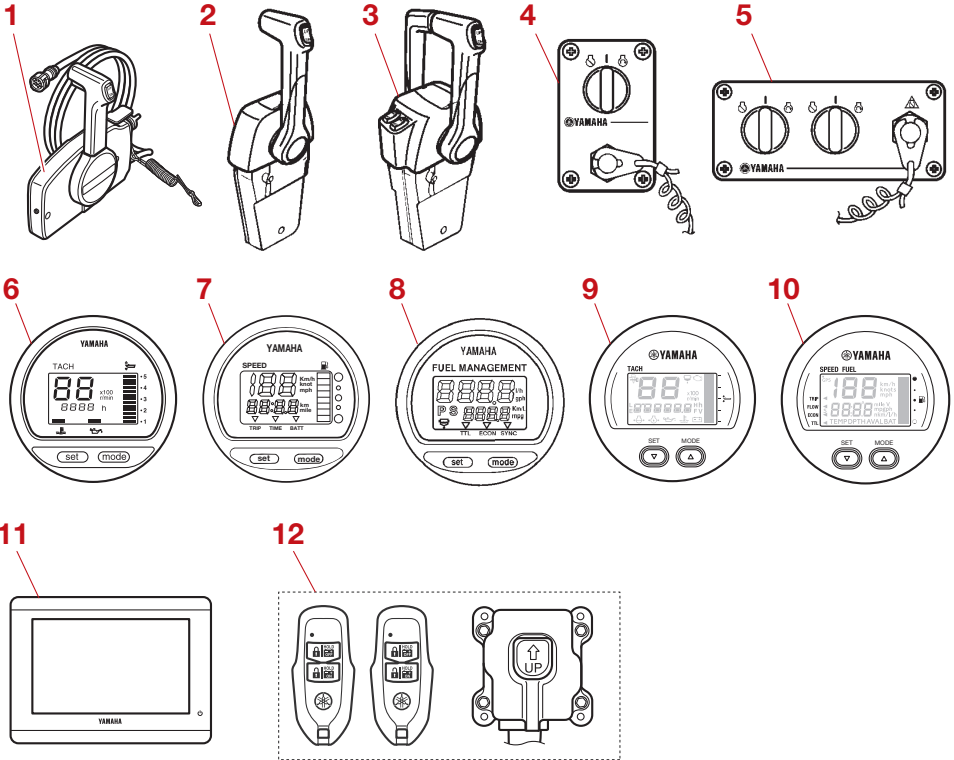

1. Remote control box (side mount type)
2. Remote control box (binnacle mount type)
3. Remote control box (binnacle mount type)
4. Switch panel (for use with binnacle type)
5. Switch panel (for use with binnacle type)
6. Digital tachometer
7. Digital speedometer
8. Fuel management meter
9. 6Y8 Multifunction tachometer
10. 6Y8 Multifunction speed & fuel meter
11. CL5 Display

12. Yamaha Security System (Y-COP)

EMU46753

Yamaha Security System (Y-COP/Optional)

ECM02461

NOTICE

The Yamaha Security System is sold in conformity with the relevant laws and regulations regarding radio wave transmission. Therefore, if this product is used

Components

outside the country where it was sold, it may violate the laws or regulations regarding radio wave transmission in the country it is used in. For details, consult your Yamaha dealer.

The Yamaha Security System, which protects against theft, consists of the receiver and key fobs. The Yamaha Security System is available from your Yamaha dealer. For details, consult your Yamaha dealer.

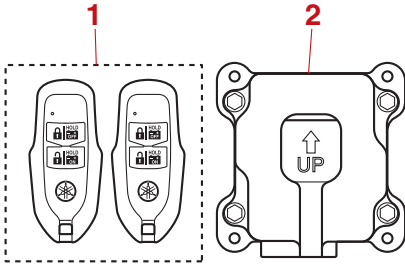

1. Key fob
2. Receiver

The engine cannot be started if the security system is in the lock mode. The engine can be started only in the unlock mode. For more information, see the installation and owner's manual included with the security system.

EMU26183

Remote control box

The remote control lever actuates both the shifter and the throttle. The electrical switches are mounted on the remote control box.

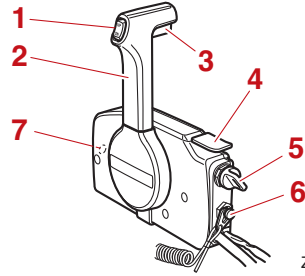

ZMU01723

1. Power trim and tilt switch
2. Remote control lever
3. Neutral interlock trigger
4. Neutral throttle lever
5. Main switch
6. Engine shut-off switch
7. Throttle friction adjuster

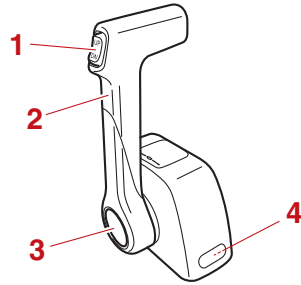

1. Power trim and tilt switch
2. Remote control lever
3. Free accelerator
4. Throttle friction adjuster

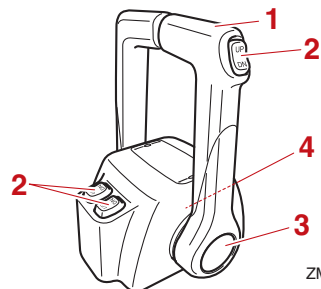

ZMU04569

1. Remote control lever

2. Power trim and tilt switch
3. Free accelerator
4. Throttle friction adjuster

EMU26192

Remote control lever

Moving the lever forward from the neutral position engages forward gear. Pulling the lever back from neutral engages reverse. The engine will continue to run at idle until the lever is moved about 35° (a detent can be felt). Moving the lever farther opens the throttle, and the engine will begin to accelerate.

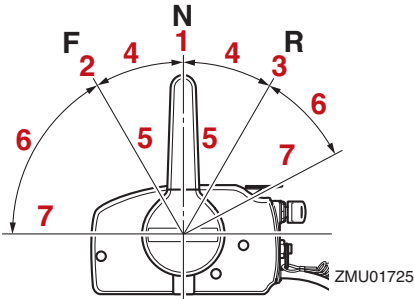

1. Neutral "N"
2. Forward "F"
3. Reverse "R"
4. Shift
5. Fully closed
6. Throttle
7. Fully open

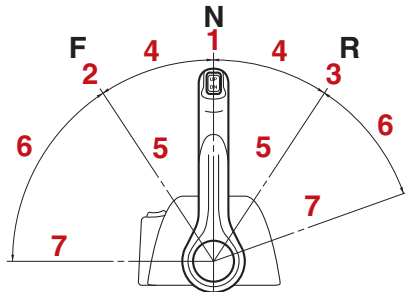

1. Neutral "N"
2. Forward "F"
3. Reverse "R"

4. Shift
5. Fully closed
6. Throttle
7. Fully open

EMU26202

Neutral interlock trigger

To shift out of neutral, first pull the neutral interlock trigger up.

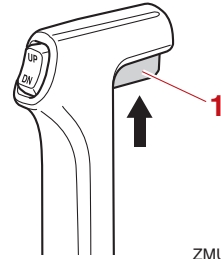

1. Neutral interlock trigger

EMU26213

Neutral throttle lever

To open the throttle without shifting into either forward or reverse, put the remote control lever in the neutral position and lift the neutral throttle lever.

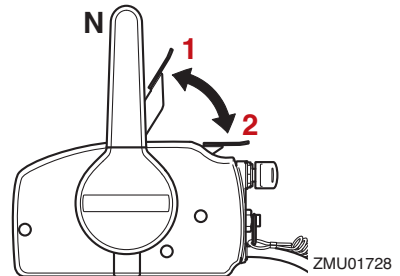

1. Fully open
2. Fully closed

Components

TIP:

The neutral throttle lever will operate only when the remote control lever is in neutral. The remote control lever will operate only when the neutral throttle lever is in the closed position.

EMU26235

Free accelerator

To open the throttle without shifting into either forward or reverse, push the free accelerator button and move the remote control lever.

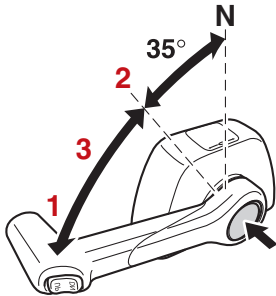

1. Fully open
2. Fully closed
3. Free accelerator

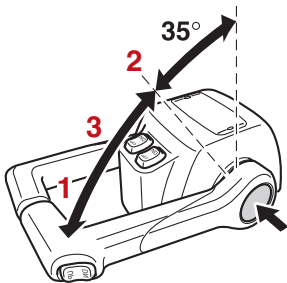

ZMU04575

1. Fully open
2. Fully closed
3. Free accelerator

TIP:

- The free accelerator button can only be pushed when the remote control lever is in the neutral position.
- After the button is pushed, the throttle begins to open after the remote control lever is moved at least 35°.
- After using the free accelerator, return the remote control lever to the neutral position. The free accelerator button will return automatically to its set position. The remote control will then engage forward and reverse normally.

EMU25978

Throttle friction adjuster

A friction device provides adjustable resistance to movement of the throttle grip or the remote control lever, and can be set according to operator preference.

To increase resistance, turn the adjuster clockwise. To decrease resistance, turn the adjuster counterclockwise. **WARNING! Do not overtighten the friction adjuster. If there is too much resistance, it could be difficult to move the remote control lever or throttle grip, which could result in an accident.** [EWM00033]

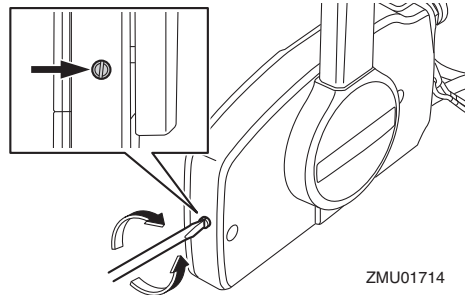

ZMU01714

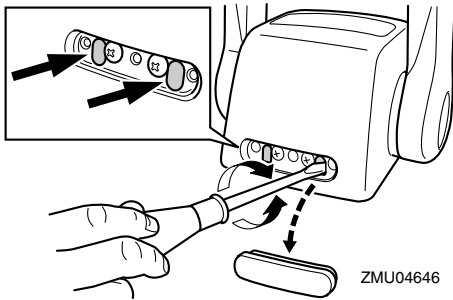
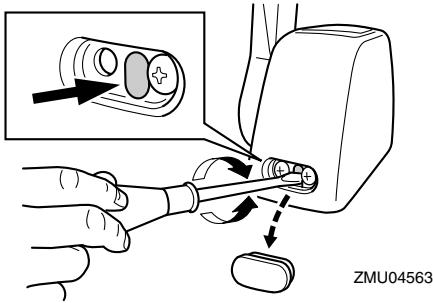

When constant speed is desired, tighten the adjuster to maintain the desired throttle setting.

EMU25996

Engine shut-off cord (lanyard) and clip

The clip must be attached to the engine shut-off switch for the engine to run. The cord should be attached to a secure place on the operator's clothing, or arm or leg. Should the operator fall overboard or leave the helm, the cord will pull out the clip, stopping ignition to the engine. This will prevent the boat from running away under power. **WARNING! Attach the engine shut-off cord to a secure place on your clothing, or your arm or leg while operating. Do not attach the cord to clothing that could tear loose. Do not route the cord where it could become entangled, preventing it from functioning. Avoid accidentally pulling the cord during normal operation. Loss of engine power**

means the loss of most steering control. Also, without engine power, the boat could slow rapidly. This could cause people and objects in the boat to be thrown forward. [EWM00123]

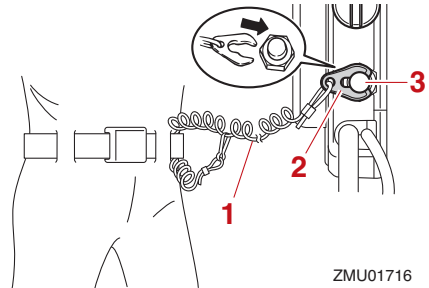

1. Engine shut-off cord (lanyard)
2. Clip
3. Engine shut-off switch

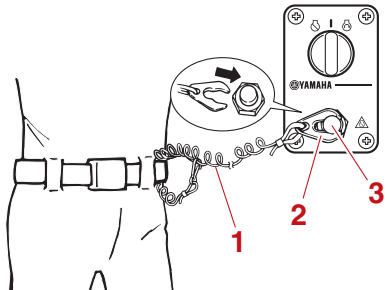

1. Engine shut-off cord (lanyard)
2. Clip
3. Engine shut-off switch

Components

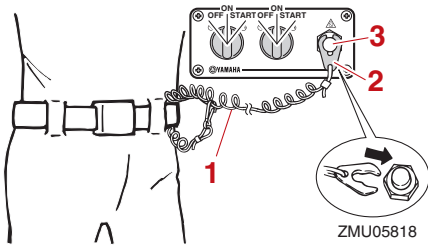

1. Engine shut-off cord (lanyard)
2. Clip
3. Engine shut-off switch

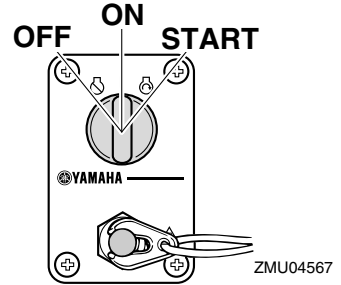

EMU26092

Main switch

The main switch controls the ignition system; its operation is described below.

● “OFF” (off)

With the main switch in the “OFF” (off) position, the electrical circuits are off, and the key can be removed.

● “ON” (on)

With the main switch in the “ON” (on) position, the electrical circuits are on, and the key cannot be removed.

● “START” (start)

With the main switch in the “START” (start) position, the starter motor turns to start the engine. When the key is released, it returns automatically to the “ON” (on) position.

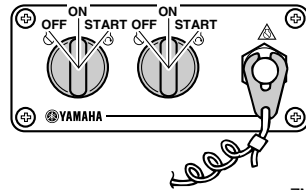

ZMU05821

EMU32054

Power trim and tilt switch on remote control

The power trim and tilt system adjusts the outboard motor angle in relation to the transom. Pushing the switch “UP” (up) trims the outboard motor up, and then tilts it up. Pushing the switch “DN” (down) tilts the outboard motor down and trims it down. When the switch is released, the outboard motor will stop in its current position. For instructions on using the power trim and tilt switch, see pages 66 and 68.

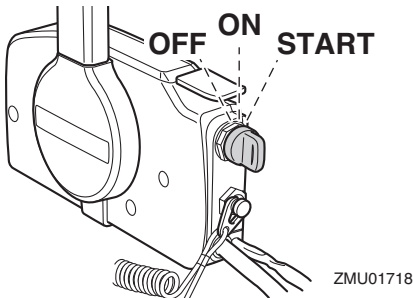

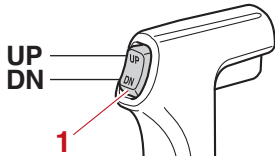

ZMU01781

1. Power trim and tilt switch

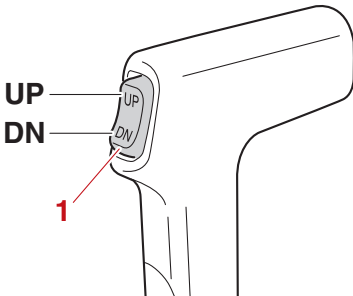

1. Power trim and tilt switch

EMU26156

Power trim and tilt switch on bottom cowling

The power trim and tilt switch is located on the side of the bottom cowling. Pushing the switch “UP” (up) trims the outboard motor up, and then tilts it up. Pushing the switch “DN” (down) tilts the outboard motor down and trims it down. When the switch is released, the outboard motor will stop in its current position.

For instructions on using the power trim and tilt switch, see page 68.

EWM01032



Use the power trim and tilt switch located on the bottom cowling only when the boat is at a complete stop with the engine off. Attempting to use this switch while the

boat is moving could increase the risk of falling overboard and could distract the operator, increasing the risk of collision with another boat or an obstacle.

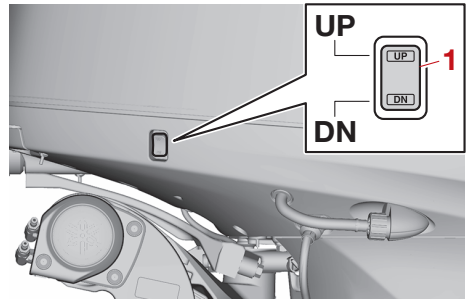

1. Power trim and tilt switch

EMU26164

Power trim and tilt switches (twin bin-nacle type)

The power trim and tilt system adjusts the outboard motor angle in relation to the transom. Pushing the switch “UP” (up) trims the outboard motor up, and then tilts it up. Pressing the switch “DN” (down) tilts the outboard motor down and trims it down. When the switch is released, the outboard motor will stop in its current position. For instructions on using the power trim and tilt switches, see pages 66 and 68.

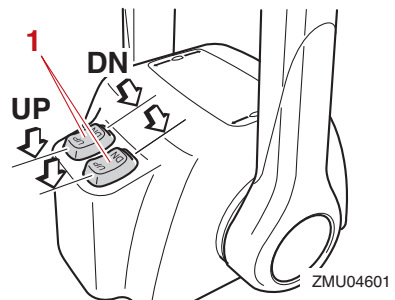

ZMU04601

1. Power trim and tilt switch

Components

TIP:

On the dual engine control, the switch on the remote control grip controls both outboard motors at the same time.

EMU26246

Trim tab with anode

EWM00841



An improperly adjusted trim tab could cause difficult steering. Always test run after the trim tab has been installed or replaced to be sure steering is correct. Be sure you have tightened the bolt after adjusting the trim tab.

The trim tab should be adjusted so that the steering control can be turned to either the right or left by applying the same amount of force.

If the boat tends to veer to the left (port side), turn the trim tab rear end to the port side "A" in the figure. If the boat tends to veer to the right (starboard side), turn the trim tab end to the starboard side "B" in the figure.

ECM00841

NOTICE

The trim tab also serves as an anode to protect the engine from electrochemical corrosion. Never paint the trim tab as it will become ineffective as an anode.

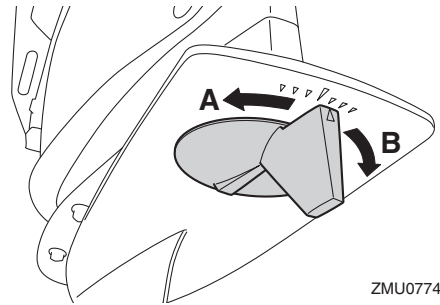
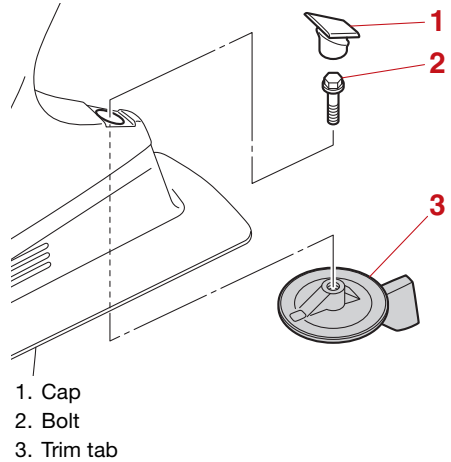

Bolt tightening torque:

42 N·m (4.2 kgf·m, 31 lb·ft)

EMU26342

Tilt support lever for power trim and tilt model

To keep the outboard motor in the tilted up position, lock the tilt support lever to the clamp bracket.

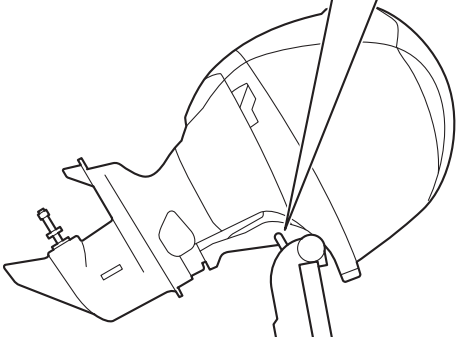
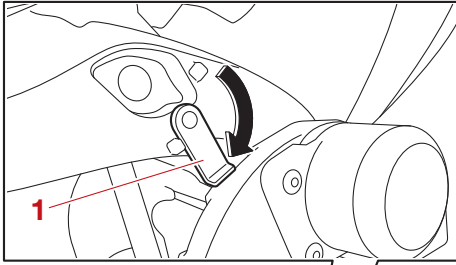

1. Tilt support lever

ECM00661

NOTICE

Do not use the tilt support lever or knob when trailering the boat. The outboard motor could shake loose from the tilt support and fall. If the motor cannot be trailered in the normal running position, use an additional support device to secure it in the tilt position.

EMU40762

Cowling lock lever

The cowling lock levers are used to secure the top cowling.

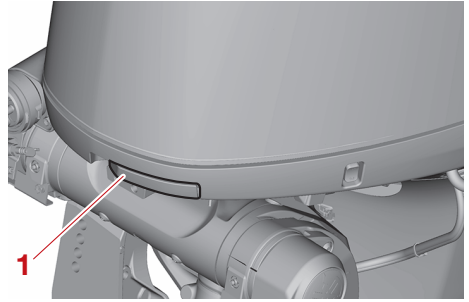

1. Cowling lock lever

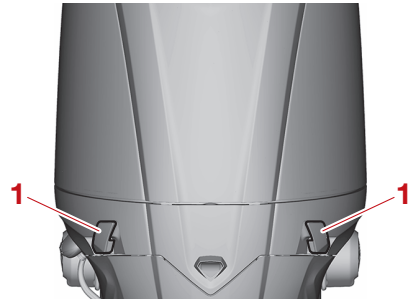

1. Cowling lock lever

EMU40803

Flushing device

The flushing device is used to clean the cooling water passages of the outboard motor using a garden hose and tap water. For instructions on using the flushing device, see page 75.

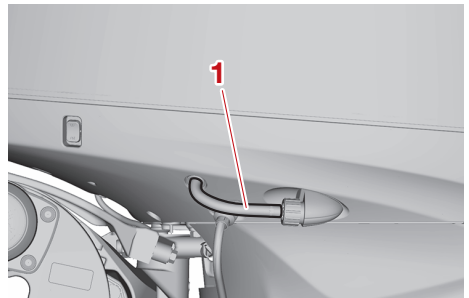

1. Flushing device

Components

EMU40823

Fuel filter

The fuel filter functions to remove foreign material and separate water from the fuel. If water separated from the fuel exceeds a specific volume, the alert system will activate. For further information, see page 51.

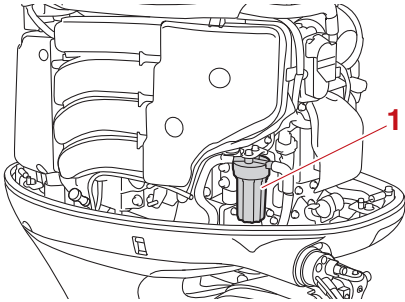

1. Fuel filter

TIP:

Adding an in-line 10-micron fuel filter has been shown to greatly reduce the chance of fuel contamination problems. Consult your dealer for information about Yamaha 10-micron fuel filters if your boat does not have one.

Instruments and indicators

EMU41391

Digital tachometer

The tachometer shows the engine speed and has the following functions.

All segments of the display will light momentarily after the main switch is turned on and will return to normal thereafter.

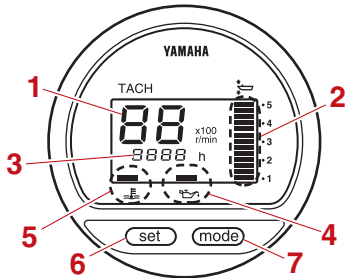

1. Tachometer
2. Trim meter
3. Hour meter
4. Low oil pressure-alert indicator
5. Overheat-alert indicator
6. Set button
7. Mode button

EMU36051

Tachometer

The tachometer displays engine speed in hundreds of revolutions per minute (r/min). For example, if the tachometer display reads "22" then the engine speed is 2200 r/min.

EMU26622

Trim meter

This meter shows the trim angle of your outboard motor.

- Memorize the trim angles that work best for your boat under different conditions. Adjust the trim angle to the desired using the power trim and tilt switch.
- If the trim angle of your motor exceeds the trim operating range, the top segment on the trim meter display will blink.

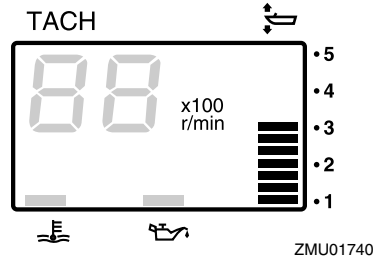

EMU26652

Hour meter

This meter shows the number of hours the engine has been run. It can be set to show the total number of hours or the number of hours for the current trip. The display can also be turned on and off.

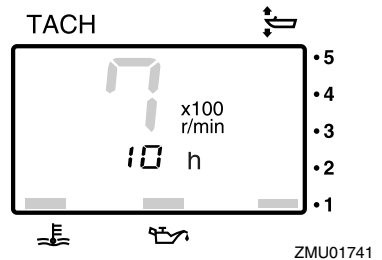

To change the display format, press the "mode" (mode) button. The display can show total hours or trip hours, or turn off.

To reset the trip hours, simultaneously press the "set" (set) and "mode" (mode) buttons for more than 1 second while the trip hours are displayed. This resets the trip counter to 0 (zero).

The total number of hours the engine has been run cannot be reset.

Instruments and indicators

EMU26526

Low oil pressure-alert indicator

If oil pressure drops too low, the alert indicator will start to blink. For further information, see page 49.

ECM00024

NOTICE

- Do not continue to run the engine if the low oil pressure-alert indicator is on and the engine oil level is lower. Serious engine damage will occur.
- The low oil pressure-alert indicator does not indicate the engine oil level. Use the oil dipstick to check the oil level. For further information, see page 57.

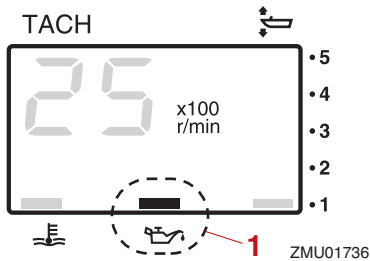

1. Low oil pressure-alert indicator

EMU26584

Overheat-alert indicator

If the engine temperature rises too high, the alert indicator will start to blink. For further information on reading the indicator, see page 49.

ECM00053

NOTICE

- Do not continue to run the engine if the overheat-alert indicator is on. Serious engine damage will occur.

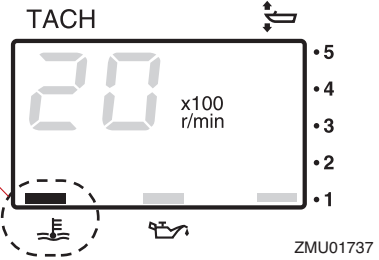

1. Overheat-alert indicator

EMU26603

Digital speedometer

This gauge shows the boat speed and other information.

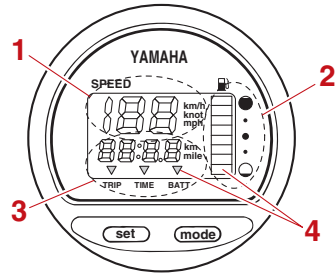

1. Speedometer
2. Fuel gauge
3. Trip meter/clock/voltmeter
4. Alert indicator(s)

All segments of the display will light momentarily after the main switch is turned on and will return to normal thereafter.

EMU36062

Speedometer

The speedometer displays km/h, mph, or knots, according to operator preference. Select the desired units of measurement by setting the selector switch on the back of the gauge. See the illustration for settings.

Instruments and indicators

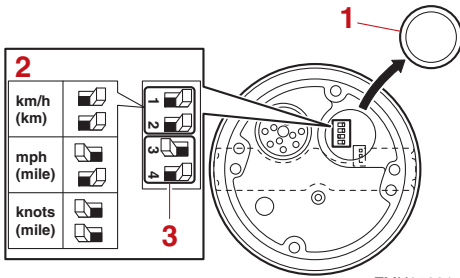

ZMU07001

1. Cap
2. Selector switch (for speed unit)
3. Selector switch (for fuel sensor)

EMU26714

Fuel gauge

Eight segments indicate the fuel level. When all segments are showing, the fuel tank is full.

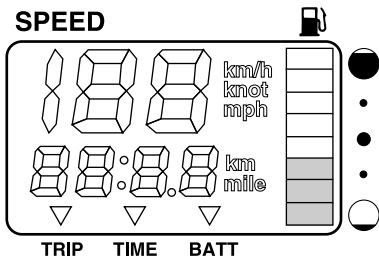

ZMU07002

The fuel level reading can be inaccurate due to the position of the sensor in the fuel tank and the attitude of the boat in the water. Operation with bow-up trim or continuous turning can give false readings.

Do not adjust the selector switch for fuel sensor. Incorrectly setting the selector switch on the gauge will give false readings. Consult your Yamaha dealer on how to correctly set the selector switch. **NOTICE: Running out of fuel can damage the engine.** [ECM01771]

EMU36072

Trip meter / Clock / Voltmeter

The display shows either the trip meter, the clock, or the voltmeter.

To change the display, press the “mode” (mode) button repeatedly until the indicator on the face of the gauge points to “TRIP” (trip meter), “TIME” (clock), or “BATT” (voltmeter).

EMU26692

Trip meter

This gauge displays the distance the boat has traveled since the gauge was last reset.

The trip distance is shown in kilometers or miles depending upon the unit of measurement selected for the speedometer.

To reset the trip meter to zero, press the “set” (set) and “mode” (mode) buttons at the same time.

The trip distance is kept in memory by battery power. The stored data will be lost if the battery is disconnected.

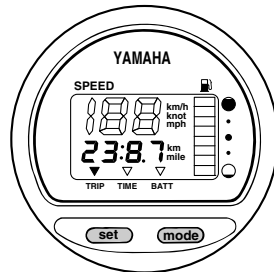

ZMU07003

EMU26702

Clock

To set the clock:

- (1) Be sure the gauge is in the “TIME” (time) mode.
- (2) Press the “set” (set) button; the hour display will begin blinking.
- (3) Press the “mode” (mode) button until the desired hour is displayed.
- (4) Press the “set” (set) button again, the minute display will begin blinking.

Instruments and indicators

- (5) Press the “mode” (mode) button until the desired minute is displayed.
- (6) Press the “set” (set) button again to start the clock.

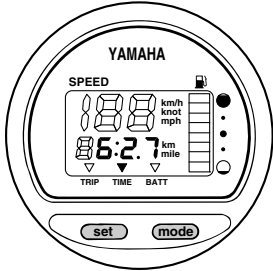

ZMU07004

The clock operates on battery power. Disconnecting the battery will stop the clock. Reset the clock after connecting the battery.

EMU36081

Voltmeter

The voltmeter displays the charge of the battery in volts(V).

EMU26723

Fuel level-alert indicator

If the fuel level decreases to one segment, the fuel level alert segment will blink.

Do not continue to operate the engine at full throttle if an alert device has activated. Get back to the port using trolling engine speed.

NOTICE: Running out of fuel can damage the engine. [ECM01771]

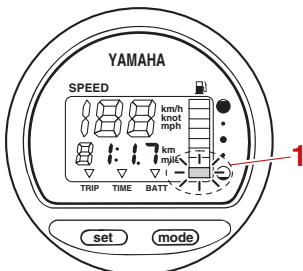

1. Fuel level-alert segment

EMU26733

Low battery voltage-alert indicator

If battery voltage drops, the display will automatically turn on and blink.

Get back to the port soon if an alert device has activated. For charging the battery, consult your Yamaha dealer.

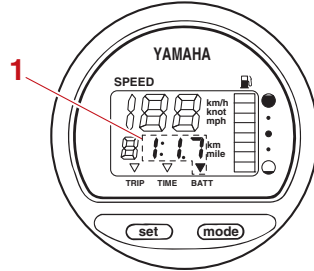

ZMU07006

1. Low battery indicator

EMU26742

Fuel management meter

The fuel management meter shows the state of the fuel consumption while the engine is running.

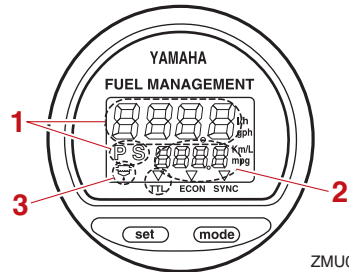

ZMU01748

1. Fuel flow meter
2. Fuel consumption meter / Fuel economy meter / Twin engine speed synchronizer
3. Water separator-alert indicator (operates only if the sensor has been installed)

All segments of the display will light momentarily after the main switch is turned on and will return to normal thereafter.

Instruments and indicators

EMU26753

Fuel flow meter

The fuel flow meter displays the amount of fuel flow over a one-hour period, at the current rate of engine operation.

- The fuel flow meter displays gallons/hour or liters/hour according to operator preference. Select the desired units of measurement by setting the selector switch on the back of the gauge during installation.

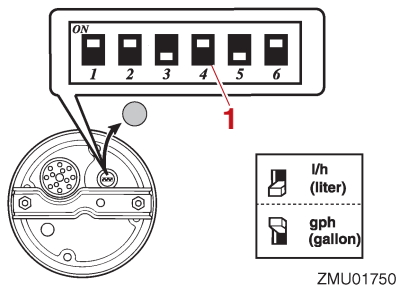

1. Selector switch

- The fuel consumption meter and fuel economy meter will indicate the same unit of measurement.

Fuel flow readings are not accurate when the engine is operating under about 1300 r/min. As the fuel pump cycles on and off, the display indicates either no fuel flow or higher flow than the actual average use.

Dual engine users: the fuel flow meter can display the fuel flow of either or both engines.

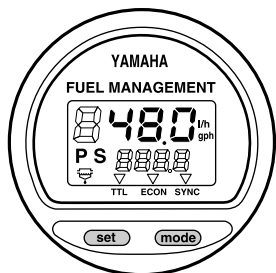

To change the fuel flow display, press the “set” (set) button repeatedly until the gauge displays “S” (for fuel flow to the starboard engine only), “P” (for fuel flow to the port engine only), or “P S” (for total fuel flow both engines).

EMU36091

Fuel consumption meter / Fuel economy meter / Twin engine speed synchronizer

The display shows either the fuel consumption meter, the fuel economy meter, or the twin engine synchronizer.

To change the display, press the “mode” (mode) button repeatedly until the indicator on the face of the gauge points to “TTL” (fuel consumption meter), “ECON” (fuel economy meter), or “SYNC” (twin engine speed synchronizer).

EMU26762

Fuel consumption meter

This gauge displays the total amount of fuel consumed since the gauge was last reset.

To reset the total fuel consumption meter to zero, press the “set” (set) and “mode” (mode) buttons at the same time.

FUEL MANAGEMENT

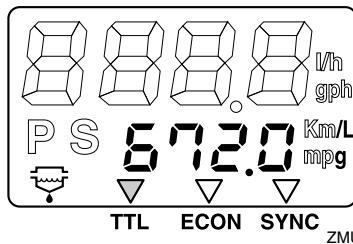

EMU26772

Fuel economy

This gauge displays the approximate distance per liter or gallon when cruising.

Instruments and indicators

FUEL MANAGEMENT

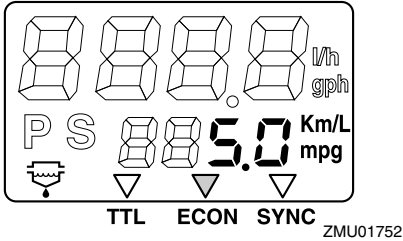

If twin engines are installed on your boat, the gauge will only display the total fuel economy of both engines.

- Fuel consumption varies greatly with boat design, weight, propeller used, engine trim angle, sea conditions (including wind), and throttle position. Fuel consumption also varies slightly with the type of water (salt, fresh, and contaminate levels), air temperature and humidity, cleanliness of the boat bottom, engine mounting height, skill of the operator, and individual gasoline formulation (winter or summer fuel and amount of additives).
- The Yamaha digital speedometer and fuel management meter calculates speed, miles traveled, and fuel economy by water movement at the stern of the boat. This distance can vary greatly from the actual distance traveled because of water currents, sea swells, and the condition of the water speed sensor (if partially plugged or damaged).
- Individual engines may slightly vary in their fuel consumption due to manufacturing variations. These variations can be even greater if the engines are of different year models. In addition, variations in propellers, even of the same basic dimensions of the same design, can also cause a slight variation in fuel consumption.

EMU26783

Twin-engine speed synchronizer

This gauge displays the difference in engine speed (r/min) between the port and starboard engines for reference purposes when synchronizing the two engines' speeds.

FUEL MANAGEMENT

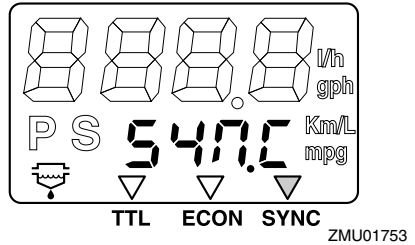

FUEL MANAGEMENT

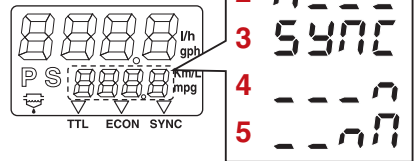

1. Port engine speed is higher
2. Port engine speed is slightly higher
3. Engine speed is synchronized evenly between port and starboard engines
4. Starboard engine speed is slightly higher
5. Starboard engine speed is higher

If the two engines' speeds are not synchronized while cruising, adjusting trim angle or throttle can synchronize them.

If large differences in trim angle or throttle are needed to synchronize the engines, consult your Yamaha dealer for adjustments to the throttle cables.

Instruments and indicators

EMU26794

Water separator-alert indicator

This indicator will blink when water has accumulated in the water separator. In such an event, stop the engine and drain the water from the separator.

This indicator only operates when a water separator sensor is equipped.

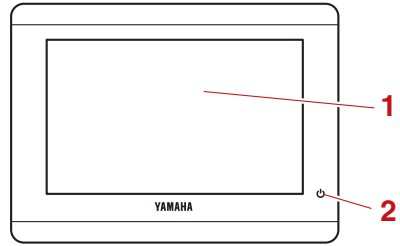

1. Touchscreen
2. Power button

FUEL MANAGEMENT

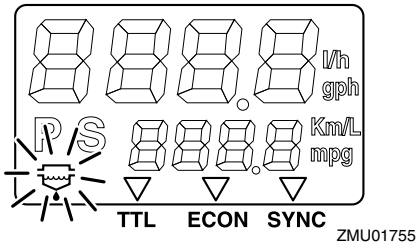

EMU48822

CL5 Display

The CL5 Display shows engine status and alert information. The display can be changed. This manual mainly covers the alert display.

If a warning message appears on the CL5 Display, follow the instructions on the display.

TIP:

- The functions shown in the display varies according to the equipment of the boat.
- For more information, see the CL5 owner's manual.

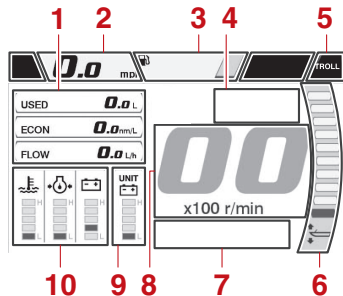

1. Boat status
2. Speedometer
3. Tank level
4. Engine condition
5. Trolling mode button
6. Trim angle
7. Engine alert
8. Tachometer
9. Sub status
10. Engine status

Engine condition icons

Orange icons indicate engine conditions.

- **Yamaha Security System indicator**  (optional)

This indicator appears when the Yamaha Security System is in lock mode. Make sure it is off before starting the engine.

Instruments and indicators

- **Engine warm-up indicator “”**

This indicator appears while the engine is being warmed up and goes off when warming-up is finished.

- **Engine synchronization indicator “”**

In multiple engine types, this indicator appears while the engines are under synchronization control. It goes off when engine synchronization control is released.

Engine alert icons

Red icons indicate engine abnormalities. When an abnormality occurs, a pop-up window will be displayed, and the buzzer will sound.

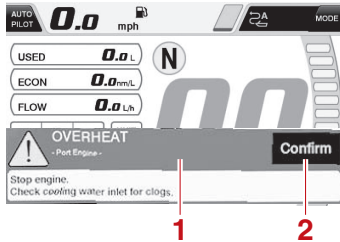

1. Pop-up window
2. Confirm button

Press the confirm button to change to the normal display. The engine alert icon will start to blink.

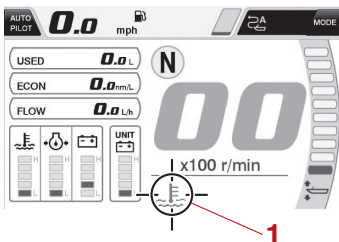

1. Engine alert icon

ECM00093

NOTICE

Do not continue to operate the engine if an alert device has activated. Consult your Yamaha dealer if the problem cannot be located and corrected.

The engine alert icon will appear according to the kind of abnormality. The symbols and their explanations are described below.

- **Overheat alert “”**

If the engine temperature rises too high while cruising, this alert will be activated. Stop the engine immediately. Check the cooling water inlet for clogging, and clear it if it is blocked.

ECM01594

NOTICE

- **Do not continue to run the engine if the overheat-alert indicator blinks. Serious engine damage will occur.**
- **Do not continue to operate the engine if an alert device has activated. Consult your Yamaha dealer if the problem cannot be located and corrected.**

- **Low oil pressure alert “”**

If the engine oil pressure drops too low, this alert will be activated. Stop the engine immediately. Check the engine oil level and replenish oil if necessary. If the alert device has activated while the appropriate engine oil level is maintained, consult your Yamaha dealer.

ECM01602

NOTICE

Do not continue to run the engine if the low oil pressure alert device has activated. Serious engine damage will occur.

Instruments and indicators

● Water in Fuel Alert “☕”

If water has accumulated in the water separator (fuel filter) while cruising, this alert will be activated. Stop the engine immediately and see page 101 of this manual to drain the water from the fuel filter. Consult a Yamaha dealer.

ECM00911

NOTICE

Gasoline mixed with water could cause damage to the engine.

● Low battery voltage alert “⚡”

If the battery voltage drops, this alert will be activated. If the low battery voltage alert device has activated, return to port and consult a Yamaha dealer immediately. To charge the battery, consult your Yamaha dealer.

● Check engine alert “🔧”

If the engine malfunctions while cruising, this alert will be activated. Return to port and consult a Yamaha dealer immediately.

● Check System / Steering Malfunction Alert

If a malfunction occurs in the system, the system alert will be activated. Return to port immediately and contact your Yamaha dealer.

EMU46654

6Y8 Multifunction meters

There are two types of 6Y8 Multifunction meters.

- 6Y8 Multifunction tachometer
- 6Y8 Multifunction speed & fuel meter

6Y8 Multifunction tachometer

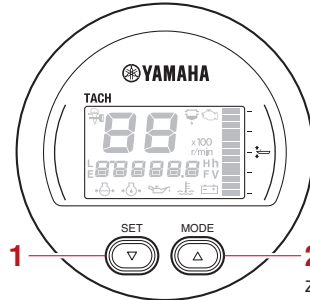

ZMU08407

1. Set button
2. Mode button

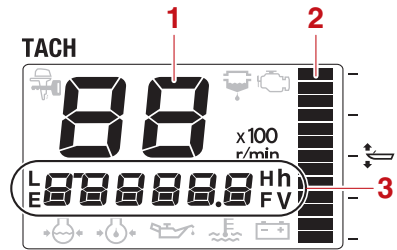

ZMU08408

1. Tachometer
2. Trim meter
3. Multifunction display

6Y8 Multifunction speed & fuel meter

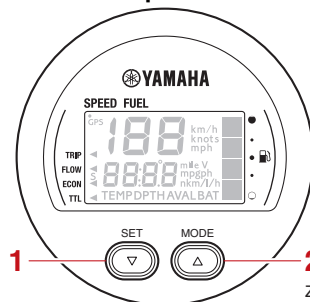

ZMU08409

1. Set button
2. Mode button

Instruments and indicators

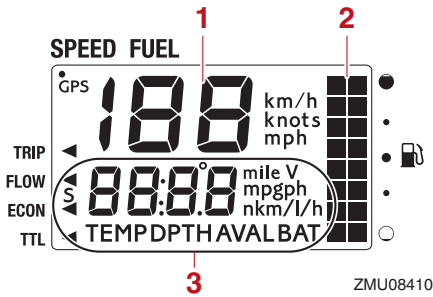

1. Speedometer
2. Fuel meter
3. Multifunction display

TIP:

The information displayed on the multifunction display can be changed. For information on other settings or changing the displayed information, see the operation manual included with the 6Y8 Multifunction meter.

This manual mainly covers the alert display of the 6Y8 Multifunction tachometer. See the following sections for information about the alert indicators.

Indicators

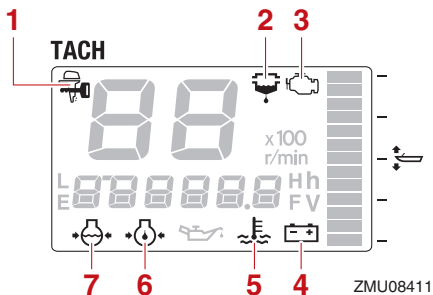

1. Yamaha Security System indicator (optional)
2. Water separator-alert indicator
3. Engine trouble-alert indicator
4. Battery voltage indicator
5. Overheat-alert indicator
6. Low oil pressure-alert indicator

7. Cooling water pressure indicator (optional)

Yamaha Security System indicator (optional)

This indicator appears, when the Yamaha Security System is in lock mode.

Lock mode

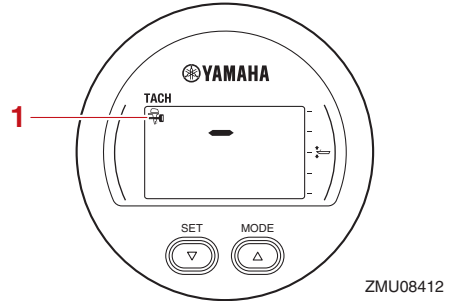

1. Yamaha Security System indicator (optional)

Make sure that the Yamaha Security System indicator is off before starting the engine.

Water separator-alert indicator

If water has accumulated in the water separator (fuel filter) while cruising, the water separator-alert indicator will start to blink.

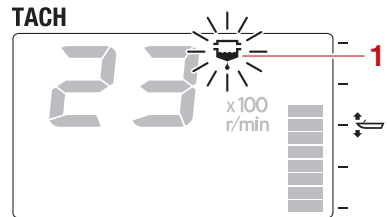

1. Water separator-alert indicator

Stop the engine immediately and see page 101 of this manual to drain the water from the fuel filter. Get back to the port soon and consult a Yamaha dealer immediately.

Instruments and indicators

ECM00911

NOTICE

Gasoline mixed with water could cause damage to the engine.

Engine trouble-alert indicator

If the engine malfunctions while cruising, the engine trouble-alert indicator will start to blink. Get back to the port soon and consult a Yamaha dealer immediately.

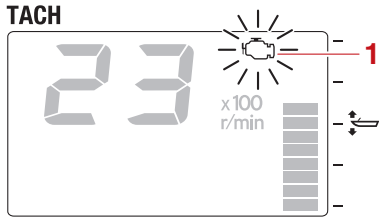

ZMU08414

1. Engine trouble-alert indicator

ECM00921

NOTICE

In such an event, the engine will not operate properly. Consult a Yamaha dealer immediately.

Low battery voltage alert

If the battery voltage drops, the battery voltage value will start to blink.

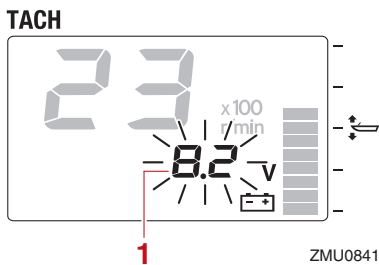

ZMU08415

1. Battery voltage value

Get back to the port soon if the low battery voltage alert device has activated. For charging the battery, consult your Yamaha dealer.

Overheat-alert indicator

If the engine temperature rises too high while cruising, the overheat-alert indicator will start to blink, and the engine speed will automatically decrease to about 2000–3500 r/min.

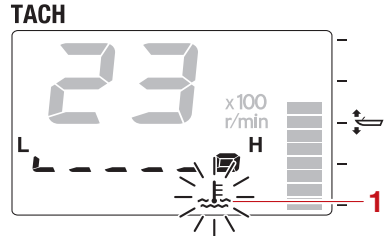

ZMU08416

1. Overheat-alert indicator

Stop the engine immediately if the buzzer sounds and the overheat device has activated. Check the cooling water inlet for clogging.

ECM01594

NOTICE

- Do not continue to run the engine if the overheat-alert indicator blinks. Serious engine damage will occur.
- Do not continue to operate the engine if an alert device has activated. Consult your Yamaha dealer if the problem cannot be located and corrected.

Low oil pressure-alert indicator

If the engine oil pressure drops too low, the low oil pressure-alert indicator will start to blink, and the engine speed will automatically decrease to about 2000–3500 r/min.

Instruments and indicators

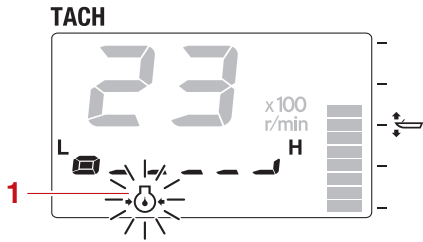

ZMU08417

1. Low oil pressure-alert indicator

Stop the engine immediately if the buzzer sounds and the low oil pressure-alert indicator blinks. Check the engine oil level and replenish oil if necessary. If the alert device has activated while the appropriate engine oil level is maintained, consult your Yamaha dealer.

ECM01602

NOTICE

Do not continue to run the engine if the low oil pressure alert device has activated. Serious engine damage will occur.

EMU26806

Alert system

ECM00093

NOTICE

Do not continue to operate the engine if an alert device has activated. Consult your Yamaha dealer if the problem cannot be located and corrected.

EMU41928

Overheat alert

This engine has an overheat-alert device. If the engine temperature rises too high, the alert device will activate.

- The engine speed will automatically decrease to about 2000–3500 r/min.
- The overheat-alert indicator will light or blink.

TACH

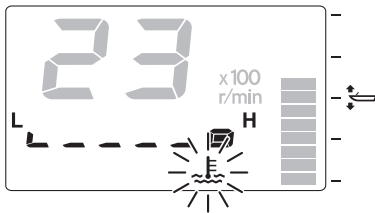

ZMU05422

- The pop-up window will appear on the Multi-Display.

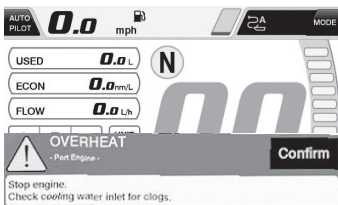

- The buzzer will sound.

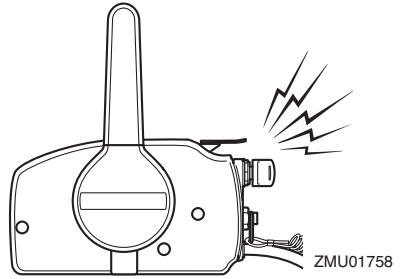

ZMU01758

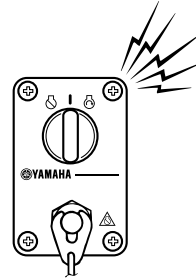

ZMU04583

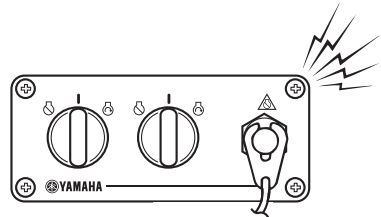

ZMU07859

If the alert system has activated, stop the engine and check the cooling water inlets:

- Check trim angle to be sure that the cooling water inlet is submerged.

Engine control system

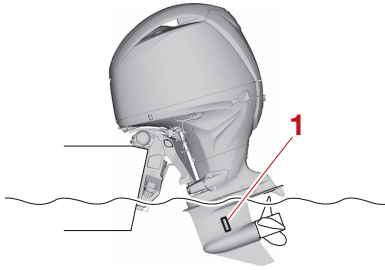

1. Cooling water inlet

- Check the cooling water inlet for clogging.

Twin engine drive users

If the overheat alert system of one outboard motor activates, the engine will slow down.

To turn off the alert activation on the outboard motors not affected by overheating

- (1) Turn the main switch to “OFF” (off) for the overheating outboard motor.

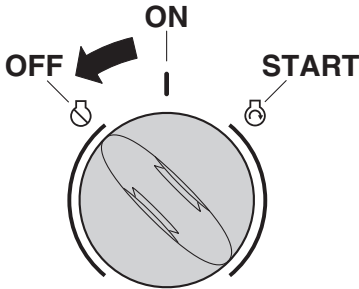

TIP:

If the alert system has activated, stop the engine and tilt the outboard motor up to check the cooling water inlets for clogging.

- (2) If the alert system is still activated, tilt the overheated outboard motor up and return to port.

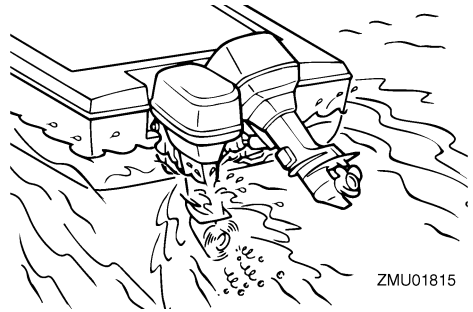

ZMU01815

EMU41938

Low oil pressure alert

If the oil pressure drops too low, the alert device will activate.

- The engine speed will automatically decrease to about 2000–3500 r/min.
- The low oil pressure-alert indicator will light or blink.

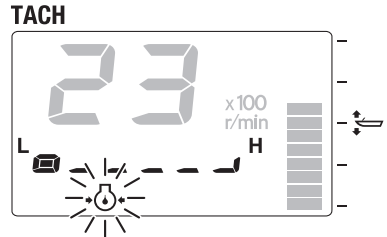

ZMU05431

- The pop-up window will appear on the Multi-Display.

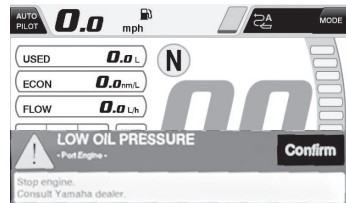

- The buzzer will sound.

Engine control system

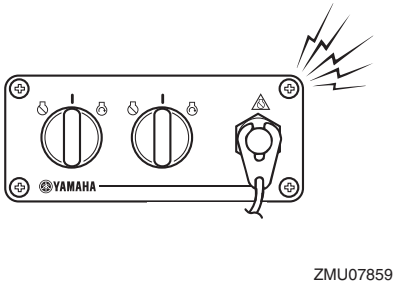
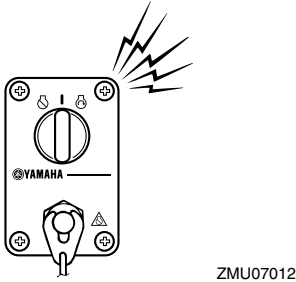
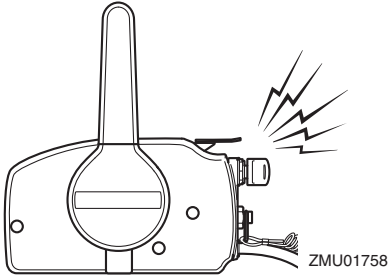

TIP:

If the alert system has activated, stop the engine as soon as it is safe to do so. Check the oil level and add oil as needed. If the oil level is correct and the alert system does not turn off, consult your Yamaha dealer.

Twin engine drive users

If the low oil pressure alert system of one outboard motor activates, all of the engines will slow down and the buzzer will sound.

To turn off the alert activation on the outboard motors not affected by the low oil pressure

Turn the main switch to “OFF” (off) for the outboard motor that has the low oil pressure.

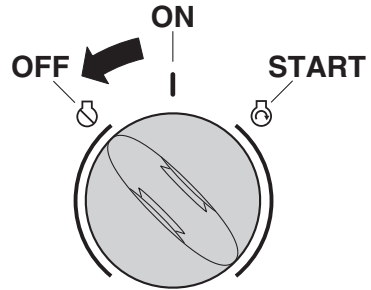

EMU41947

Water separator alert

The outboard motor is equipped with a water separator alert system. If water separated from the fuel exceeds a specific volume, the alert system will activate.

- The water separator-alert indicator will come on or blink.

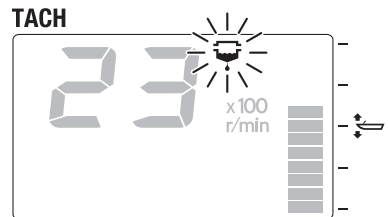

ZMU05424

- The pop-up window will appear on the Multi-Display.

Engine control system



- The buzzer will sound intermittently when the control lever is in the neutral position.

If the alert system has activated

Stop the engine and see page 103 of this manual to drain the water from the fuel filter. Return to port and consult a Yamaha dealer immediately.

ECM02471

NOTICE

Although the buzzer will stop when the engine is started and the control lever is moved to the forward or reverse position, do not use the outboard motor. Otherwise, serious engine damage could occur.

EMU26903

Installation

The information presented in this section is intended as reference only. It is not possible to provide complete instructions for every possible boat and motor combination. Proper mounting depends in part on experience and the specific boat and motor combination.

EWM01591



WARNING

- **Overpowering a boat could cause severe instability. Do not install an outboard motor with more horsepower than the maximum rating on the capacity plate of the boat. If the boat does not have a capacity plate, consult the boat manufacturer.**
- **Improper mounting of the outboard motor could result in hazardous conditions such as poor handling, loss of control, or fire hazards. For permanently mounted models, your dealer or other person experienced in proper rigging should mount the motor.**

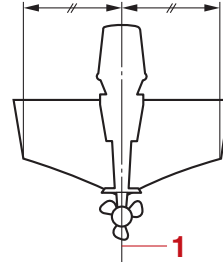

1. Center line (keel line)

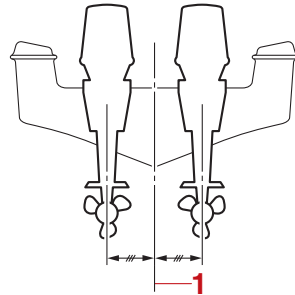

1. Center line (keel line)

EMU33483

Mounting the outboard motor

The outboard motor should be mounted so that the boat is well balanced. Otherwise, the boat could be hard to steer. For single-engine boats, mount the outboard motor on the centerline (keel line) of the boat.

For twin engine boats, mount the outboard motors equidistant from the centerline.

Consult your Yamaha dealer or boat manufacturer for further information on determining the proper mounting location.

EMU26937

Mounting height (boat bottom)

The mounting height of your outboard motor affects its efficiency and reliability. If it is mounted too high, propeller ventilation may occur, which will reduce propulsion due to excessive propeller slip, and the water intakes for the cooling system may not get an adequate water supply, which can cause engine overheating. If the engine is mounted too low, water resistance (drag) will increase, thereby reducing engine efficiency and performance.

Most commonly, an outboard motor should be mounted so that the anti-cavitation plate is in alignment with the bottom of the boat. The optimum mounting height of the outboard motor is affected by the boat/motor combination and the desired use. Test runs at different heights can help determine the

Installation

optimum mounting height. Consult your Yamaha dealer or boat manufacturer for further information on determining the proper mounting height.

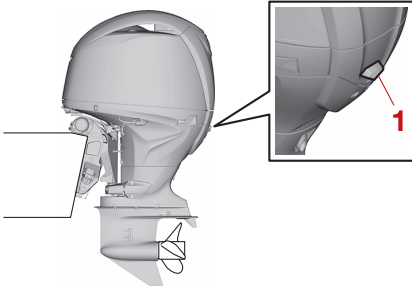

1. Idle hole

ECM01635

NOTICE

- **Make sure that the idle hole is high enough to prevent water from entering the engine even if the boat is stationary with the maximum load.**
 - **Incorrect engine height or obstructions to the smooth flow of water (such as the design or condition of the boat, or accessories, such as transom ladders or depth finder transducers) can create airborne water spray while the boat is cruising. If the outboard motor is operated continuously in the presence of airborne water spray, enough water could enter the engine through the air intake opening in the top cowling to cause severe engine damage. Remove the cause of the airborne water spray.**
-

EMU36382

First-time operation

EMU40512

Filling engine oil

The outboard motor is shipped from the factory without engine oil. If your Yamaha dealer did not fill the engine with engine oil, you must fill the engine before starting it. **NOTICE: Make sure that the engine is filled with engine oil before operating the outboard motor for the first time. Otherwise, the engine could be damaged severely.**

[ECM02241]

The following tag, which is fitted on the outboard motor when it is shipped from the factory, should be removed after the engine is filled with engine oil for the first time. For more information on checking the engine oil level, see page 57.



EMU30175

Breaking in engine

Your new engine requires a period of break-in to allow mating surfaces of moving parts to wear in evenly. Correct break-in will help ensure proper performance and longer engine life. **NOTICE: Failure to follow the break-in procedure could result in reduced engine life or even severe engine damage.** [ECM00802]

EMU41223

Procedure for breaking in engine

Your new engine requires a period of 10 hours break-in so that mating surfaces of moving parts wear in evenly.

Operate the engine in the water under load (in gear with a propeller installed) for 10 hours as follows. When breaking in the engine, avoid extended idling, rough water, and crowded areas.

- (1) For the 1st hour of operation:
Operate the engine at varying speeds up to 2000 r/min or approximately 1/2 throttle.
- (2) For the 2nd hour of operation:
Increase the engine speed until the boat is on plane (but avoid full-throttle operation), and then back off on the throttle while keeping the boat at a planing speed.
- (3) For the remaining 8 hours of operation:
Operate the engine at any speed. However, avoid operating at full throttle for more than 5 minutes at a time.
- (4) After the 1st 10 hours of operation:
Operate the engine normally.

EMU36402

Getting to know your boat

All boats have unique handling characteristics. Operate cautiously while you learn how your boat handles under different conditions and various trim angles (see page 66).

Operation

EMU36414

Checks before starting engine

EWM01922

WARNING

If any item in “Checks before starting engine” is not working properly, have it inspected and repaired before operating the outboard motor. Otherwise, an accident could occur.

ECM00121

NOTICE

Do not start the engine out of water. Overheating and serious engine damage can occur.

EMU36422

Fuel level

Be sure you have plenty of fuel for your trip. A good rule is to use 1/3 of your fuel to get to the destination, 1/3 to return, and to keep 1/3 as an emergency reserve. With the boat level on a trailer or in the water, turn the key to “ON” (on) and check the fuel level. For fuel filling instructions, see page 60.

EMU40774

Removing top cowling

For the following checks, remove the top cowling from the bottom cowling.

To remove the top cowling, pull the cowling lock levers and lift up the top cowling.

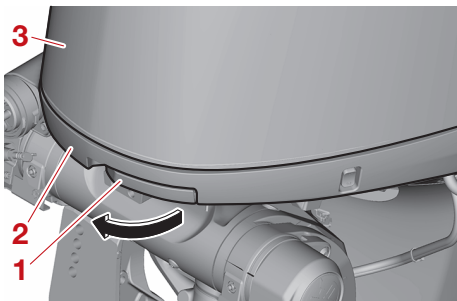

1. Cowling lock lever

2. Bottom cowling
3. Top cowling

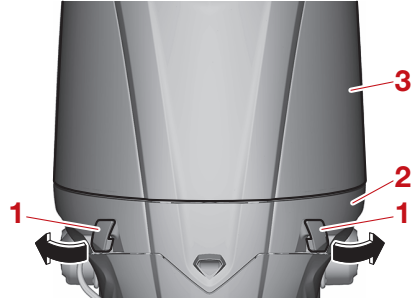

1. Cowling lock lever
2. Bottom cowling
3. Top cowling

EMU36443

Fuel system

EWM00061

WARNING

Gasoline and its vapors are highly flammable and explosive. Keep away from sparks, cigarettes, flames, or other sources of ignition.

EWM00911

WARNING

Leaking fuel can result in fire or explosion.

- Check for fuel leakage regularly.
- If any fuel leakage is found, the fuel system must be repaired by a qualified mechanic. Improper repairs can make the outboard unsafe to operate.

EMU36453

Check for fuel leaks

- Check for fuel leaks or gasoline fumes in the boat.
- Check for fuel leakage from the fuel system.
- Check the fuel tank and fuel lines for cracks, swellings, or other damage.

EMU37323

Checking the fuel filter

Check that the fuel filter is clean and free of water. If any water is found in the fuel, or if a significant amount of debris is found, the fuel tank should be checked and cleaned by a Yamaha dealer.

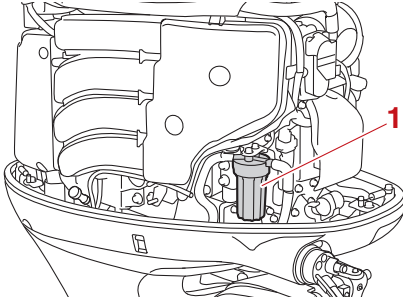

1. Fuel filter

EMU40543

Controls

- (1) Turn the steering wheel fully to the left and right and make sure operation is smooth and unrestricted throughout the whole range with no binding or excessive free play.
- (2) Operate the remote control lever several times to make sure that there is no hesitation in its travel. Operation should be smooth over the complete range of motion.
- (3) Look for loose or damaged connections of the throttle and shift cables.

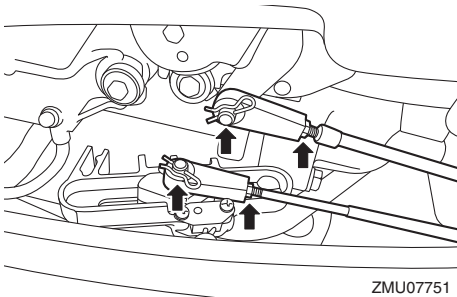

ZMU07751

EMU40363

Engine shut-off cord (lanyard)

Check the engine shut-off cord and clip for damage, such as cuts, breaks, and wear.

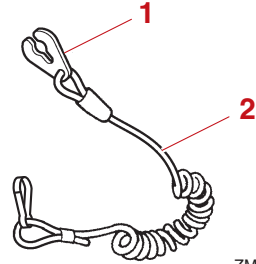

ZMU06873

1. Clip
2. Engine shut-off cord (lanyard)

EMU40994

Engine oil

- (1) Place the outboard motor in a vertical position (not tilted). **NOTICE: If the outboard motor is not level, the oil level indicated on the oil dipstick may not be accurate.** [ECM01862]
- (2) Remove the oil dipstick and wipe it clean.

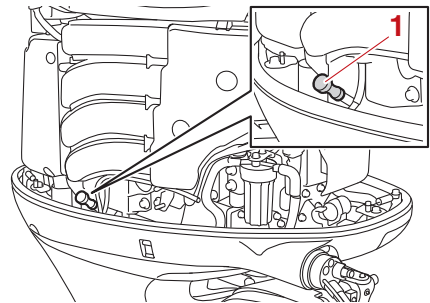

1. Oil dipstick
- (3) Insert the oil dipstick completely and remove it again.

Operation

- (4) Check that the oil level on the oil dipstick is between the upper and lower marks. Consult your Yamaha dealer if the oil level is not at the proper level or if it appears milky or dirty.

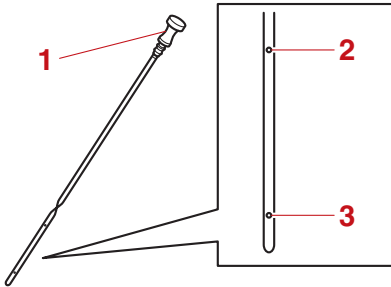

1. Oil dipstick
2. Upper mark
3. Lower mark

EMU40412

Outboard motor

- Check that the outboard motor is mounted properly and check the outboard motor mounting bolts for looseness.
- Check the propeller for damage.
- Check for engine oil leaks.

EMU36494

Flushing device

Check that the flushing device's garden hose connector is securely screwed on to the fitting on the bottom cowling. **NOTICE: If the garden hose connector is not properly connected, cooling water can leak out and the engine can overheat during operation.**

[ECM01802]

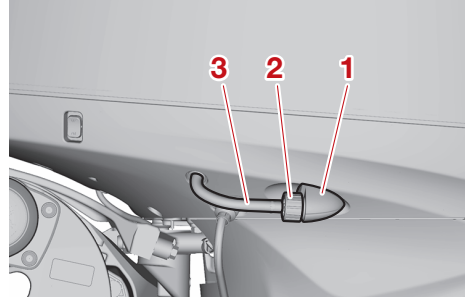

1. Fitting
2. Garden hose connector
3. Flushing device

EMU40752

Installing top cowling

- (1) Check the rubber seal for damage. If the rubber seal is damaged, have it replaced by a Yamaha dealer.

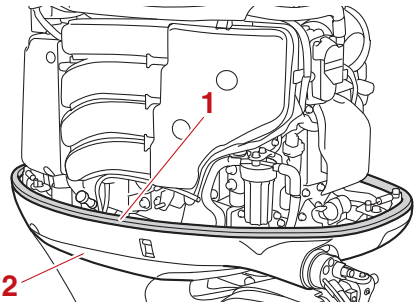

1. Rubber seal
2. Bottom cowling

- (2) Check that the rubber seal is seated all the way around the bottom cowling.
- (3) Check that all of the cowling lock levers are pulled outward.
- (4) Align the 3 protrusions on the top cowling with the corresponding holders on the bottom cowling, and then place the top cowling on the bottom cowling.

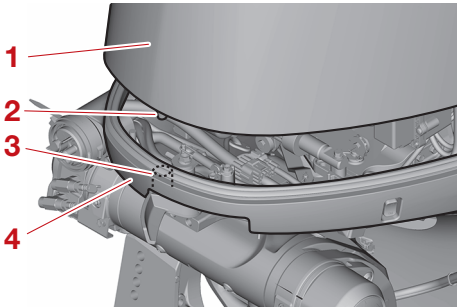

1. Top cowling
2. Protrusion
3. Holder
4. Bottom cowling

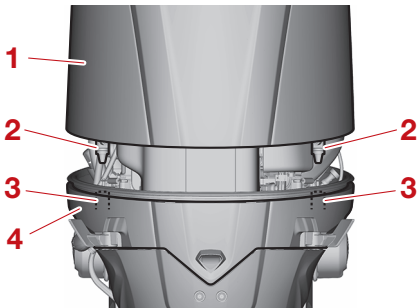

1. Top cowling
2. Protrusion
3. Holder
4. Bottom cowling

- (5) Push the cowling lock levers inward to secure the top cowling.

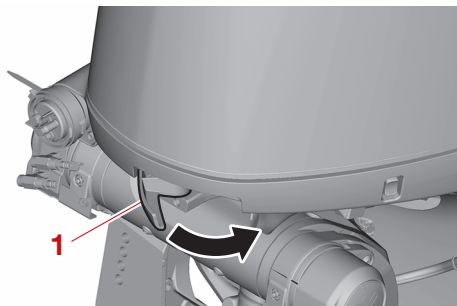

1. Cowling lock lever

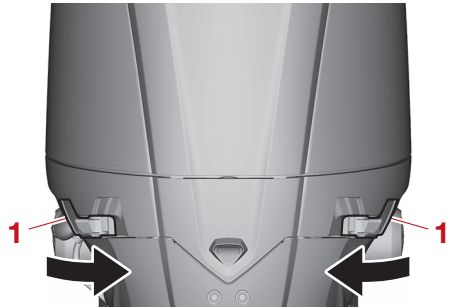

1. Cowling lock lever

- (6) Check the fitting of the top cowling by pushing it with both hands. **NOTICE: If the top cowling is not installed correctly, water can enter the top cowling and damage the engine, or the top cowling can blow off at high speeds.**

[ECM02371]

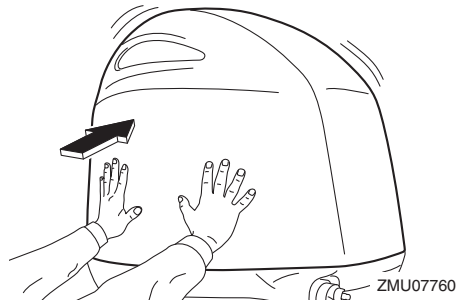

EMU34582

Power trim and tilt system

EWM01931

WARNING

- Never get under the lower unit while it is tilted, even when the tilt support lever is locked. Severe injury could occur if the outboard motor accidentally falls.
- Body parts can be crushed between the motor and the clamp bracket when the motor is trimmed or tilted.
- Be sure no one is near the outboard motor before performing this check.

Operation

- (1) Check the power trim and tilt unit for any sign of oil leaks.
- (2) Operate each of the power trim and tilt switches to check that all switches work.
- (3) Tilt the outboard motor up and check that the trim and tilt rod is pushed out completely.

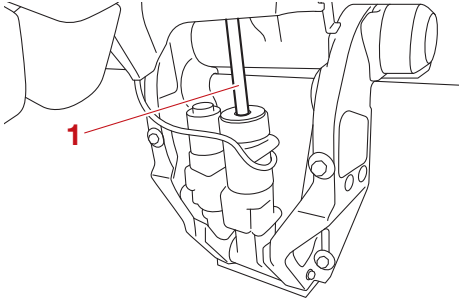

1. Trim and tilt rod

- (4) Check that the trim and tilt rod is free of corrosion or other flaws.
- (5) Tilt the outboard motor down. Check that the trim and tilt rod operates smoothly.

EMU36585

Battery

Check the battery's charge. If your boat is equipped with a Yamaha digital speedometer, the voltmeter and low battery alert functions will help you monitor the battery's charge. A battery in good condition will provide a minimum of 12 volts. Check that the battery connections are clean, secure and covered by insulating covers. The electrical connections of the battery and cables must be clean and properly connected or the battery will not start the engine.

If the battery needs charging, consult your Yamaha dealer or the battery manufacturer's instructions.

EMU30028

Filling fuel

EWMO1831



- Gasoline and its vapors are highly flammable and explosive. Always refuel according to this procedure to reduce the risk of fire and explosion.
- Gasoline is poisonous and can cause injury or death. Handle gasoline with care. Never siphon gasoline by mouth. If you should swallow some gasoline or inhale a lot of gasoline vapor, or get some gasoline in your eyes, see your doctor immediately. If gasoline spills on your skin, wash with soap and water. If gasoline spills on your clothing, change your clothes.

Before refueling, check the following points:

- Ensure the engine is stopped.
 - Securely moor the boat in a well-ventilated area and stop the engine. If the boat is trailered, make sure that it is stable.
 - Make sure that no one is in the boat.
 - Do not smoke and keep away from sparks, flames, static electric discharge, or other sources of ignition.
 - If you use a portable container to store and dispense fuel, only use a locally approved GASOLINE container.
 - To prevent electrostatic sparks, discharge any built-up static electricity from your body before refueling.
- (1) Remove the fuel tank cap.
 - (2) Fill the fuel tank with fuel. **WARNING! Do not overfill. Otherwise fuel can expand and overflow if the temperature increases.** [EWMO2611]
 - (3) Tighten the fuel tank cap securely.

- (4) Wipe up any spilled gasoline immediately with dry rags. Dispose of rags properly according to local laws or regulations.

EMU40252

Operating engine

EWM02601

WARNING

This product emits exhaust gases which contain carbon monoxide, a colorless, odorless gas which could cause brain damage or death when inhaled. Symptoms include nausea, dizziness, and drowsiness. Keep cockpit and cabin areas well ventilated. Avoid blocking exhaust outlets.

EMU31814

Sending fuel

- (1) If there is a fuel joint or a fuel valve on the boat, firmly connect the fuel line to the joint or open the fuel valve.
- (2) Squeeze the primer pump, with the arrow pointing up, until you feel it become firm.

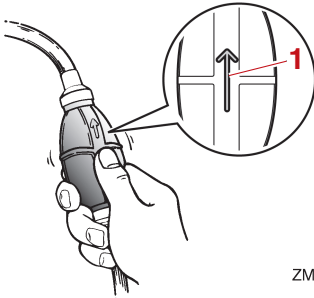

ZMU02025

1. Arrow

EMU27496

Starting engine

EWM01601

WARNING

Before starting the engine, make sure that the boat is tightly moored and that you can steer clear of any obstructions. Be sure there are no swimmers in the water near you.

EMU2762C

Electric start and remote control models

EWM01842

WARNING

- Failure to attach the engine shut-off cord could result in a runaway boat if operator is ejected. Attach the engine shut-off cord to a secure place on your clothing, or your arm or leg while operating. Do not attach the cord to clothing that could tear loose. Do not route the cord where it could become entangled, preventing it from functioning.
- Avoid accidentally pulling the cord during normal operation. Loss of engine power means the loss of most steering control. Also, without engine power, the boat could slow rapidly. This could cause people and objects in the boat to be thrown forward.

- (1) Place the remote control lever in "N" (neutral).

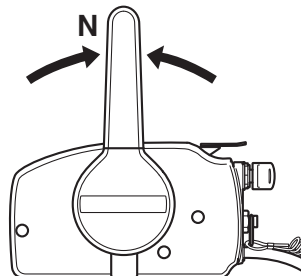

ZMU01771

Operation

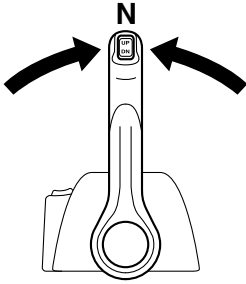

ZMU04588

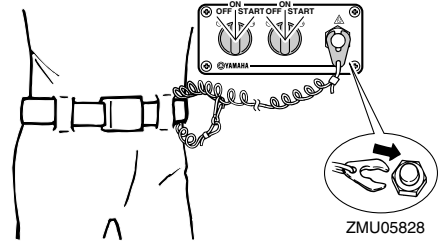

ZMU05828

TIP:

The start-in-gear protection device prevents the engine from starting except when in neutral.

- (2) Attach the engine shut-off cord to a secure place on your clothing, or your arm or leg. Then install the clip on the other end of the cord into the engine shut-off switch.

- (3) Turn the main switch to "ON" (on).

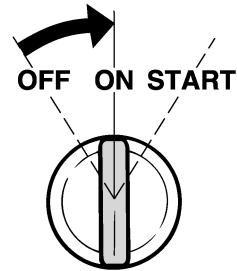

ZMU01773

TIP:

Dual engine users: When the main switch is turned on, the buzzer operates for a few seconds then stops automatically. The buzzer also operates if one of the engines stalls.

- (4) Turn the main switch to "START" (start), and hold it for a maximum of 5 seconds.

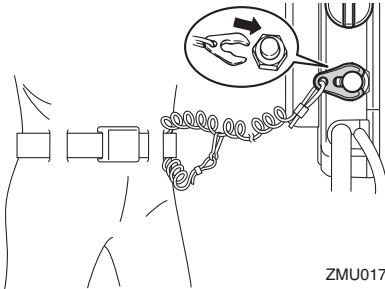

ZMU01772

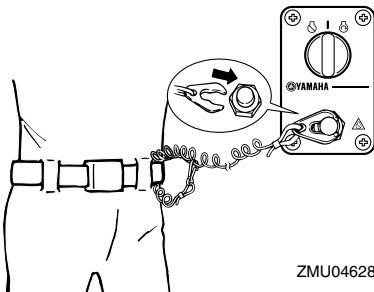

ZMU04628

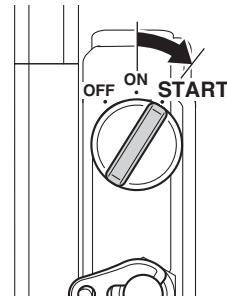

ZMU01881

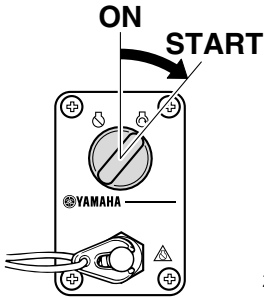

ZMU06928

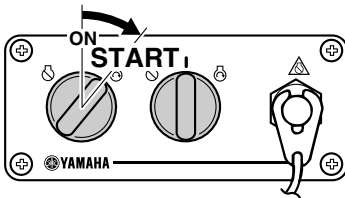

ZMU05830

- (5) Immediately after the engine starts, release the main switch to return it to “ON” (on). **NOTICE:** Never turn the main switch to “START” (start) while the engine is running. Do not keep the starter motor turning for more than 5 seconds. If the starter motor is turned continuously for more than 5 seconds, the battery will be quickly discharged, thus making it impossible to start the engine. The starter can also be damaged. If the engine will not start after 5 seconds of cranking, return the main switch to “ON” (on), wait 10 seconds, then crank the engine again. [ECM00193]

EMU36511

Checks after starting engine

EMU41361

Cooling water

Check for a steady flow of water from the cooling water pilot hole. A continuous flow of water from the cooling water pilot hole shows that the water pump is pumping water through the cooling water passages.

TIP:

When the engine is started, there may be a slight delay before water flows from the cooling water pilot hole.

ECM02251

NOTICE

If water is not flowing out of the cooling water pilot hole at all times while the engine is running, overheating and serious damage could occur. Stop the engine and check whether the cooling water inlet on the lower case or the cooling water pilot hole is blocked. Consult your Yamaha dealer if the problem cannot be located and corrected.

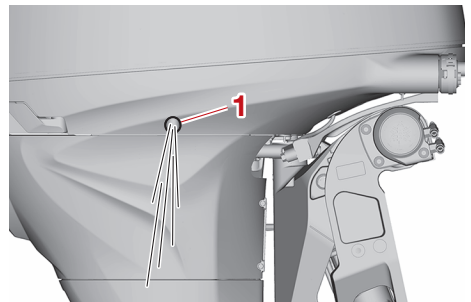

1. Cooling water pilot hole

Operation

EMU27671

Warming up engine

EMU41234

Procedure for warming up engine

- (1) After starting the engine, warm up the engine until the engine speed stabilizes at idle speed to provide maximum operating performance and acceleration.

NOTICE: Failure to do so will shorten engine life. [ECM04550]

Idle speed (in neutral):
650–750 r/min

- (2) Check that the low oil pressure-alert indicator remains off. **NOTICE:** If the low oil pressure-alert indicator blinks after the engine starts, stop the engine. Otherwise, serious engine damage could occur. Consult your Yamaha dealer. [ECM02381]

EMU36532

Checks after engine warm up

EMU36542

Shifting

While the boat is tightly moored, and without applying throttle, confirm that the engine shifts smoothly into forward and reverse, and back to neutral.

EMU40461

Stop switches

Perform the following procedure to check that the main switch and engine shut-off switch operate properly.

- Check that the engine stops when the main switch is turned to the “OFF” (off) position.
- Check that the engine stops when the clip is pulled from the engine shut-off switch.
- Check that the engine cannot be started with the clip removed from the engine shut-off switch.

EMU31736

Shifting

EWMO0181

WARNING

Before shifting, make sure there are no swimmers or obstacles in the water near you.

ECM01611

NOTICE

Warm up the engine before shifting into gear. Until the engine is warm, the idle speed may be higher than normal. High idle speed can prevent you from shifting back to neutral. If this occurs, stop the engine, shift to neutral, then restart the engine and allow it to warm up.

To shift out of neutral

- (1) Pull the neutral interlock trigger up (if equipped).

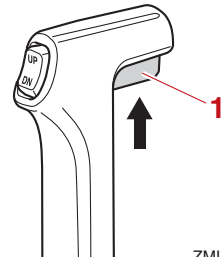

ZMU01727

1. Neutral interlock trigger
- (2) Move the remote control lever to the forward position or reverse position about 35° (a detent can be felt).

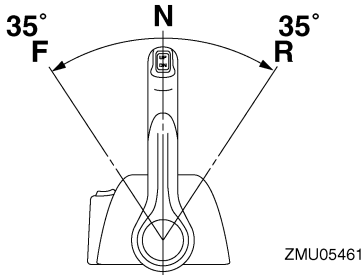
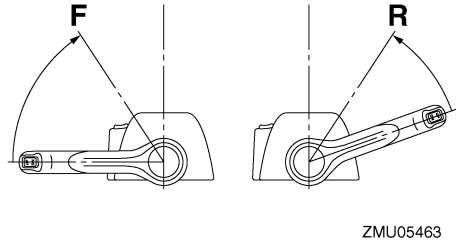
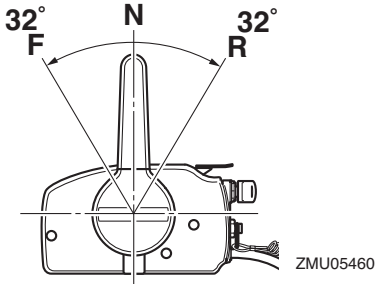

- (2) After the engine is at idle speed in gear, move the remote control lever to the neutral position.

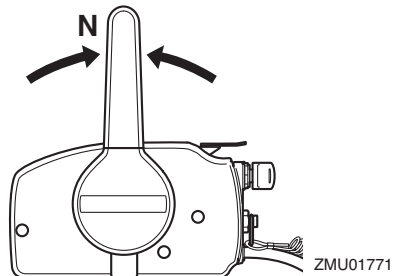

To shift from in gear (forward/reverse) to neutral

- (1) Close the throttle so that the engine slows to idle speed.

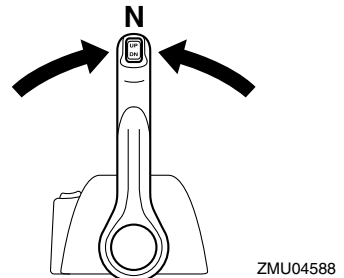
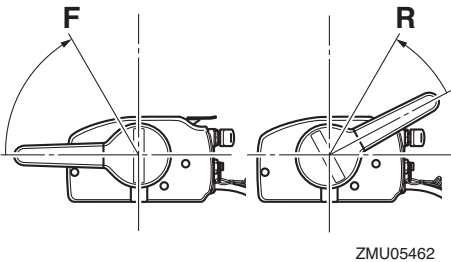

EMU31743

Stopping boat

EWM01511

WARNING

- Do not use the reverse function to slow down or stop the boat as it could cause you to lose control, be ejected, or impact the steering wheel or other parts of

Operation

the boat. This could increase the risk of serious injury. It could also damage the shift mechanism.

- Do not shift into reverse while traveling at planing speeds. Loss of control, boat swamping, or damage to the boat could occur.

The boat is not equipped with a separate braking system. Water resistance stops it after the throttle lever is moved back to idle. The stopping distance varies depending on gross weight, water surface conditions, and wind direction.

EMU27823

Stopping engine

Before stopping the engine, first let it cool off for a few minutes at idle or low speed. Stopping the engine immediately after operating at high speed is not recommended.

EMU31833

Procedure

- (1) Turn the main switch to "OFF" (off).

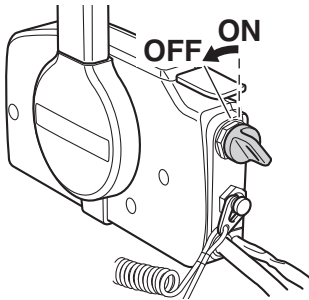

ZMU01779

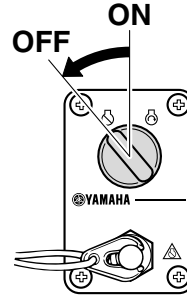

ZMU06932

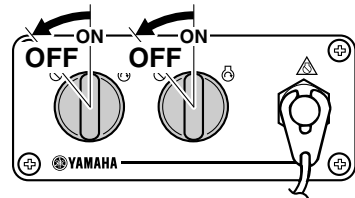

ZMU05833

- (2) Remove the key if the boat will be left unattended.

TIP:

The engine can also be stopped by pulling the cord and removing the clip from the engine shut-off switch, then turning the main switch to "OFF" (off).

EMU27865

Trimming outboard motor

EWM00741



WARNING

Excessive trim for the operating conditions (either trim up or trim down) can cause boat instability and can make steering the boat more difficult. This increases the possibility of an accident. If the boat begins to feel unstable or is hard to steer, slow down and/or readjust the trim angle.

The trim angle of the outboard motor helps determine the position of the bow of the boat in the water. Correct trim angle will help im-

prove performance and fuel economy while reducing strain on the engine. Correct trim angle depends upon the combination of boat, engine, and propeller. Correct trim is also affected by variables such as the load in the boat, sea conditions, and running speed.

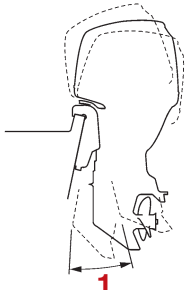

1. Trim operating angle

EMU27889

Adjusting trim angle (Power trim and tilt)

EWM00754

WARNING

- Be sure all people are clear of the outboard motor when adjusting the trim angle. Body parts can be crushed between the motor and the clamp bracket when the motor is trimmed or tilted.
- Use caution when trying a trim position for the first time. Increase speed gradually and watch for any signs of instability or control problems. Improper trim angle can cause loss of control.
- If equipped with a power trim and tilt switch located on the bottom cowling, use the switch only when the boat is at a complete stop with the engine off. Do not adjust the trim angle with this switch while the boat is moving.

Adjust the outboard motor trim angle using the power trim and tilt switch.

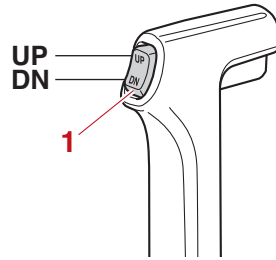

ZMU01781

1. Power trim and tilt switch

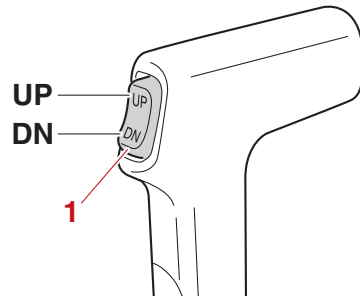

1. Power trim and tilt switch

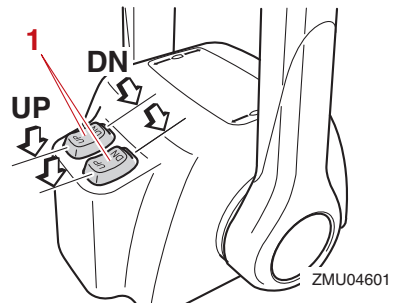

ZMU04601

1. Power trim and tilt switch

To raise the bow (trim-out), press the switch “UP” (up).

To lower the bow (trim-in), press the switch “DN” (down).

Make test runs with the trim set to different angles to find the position that works best for your boat and operating conditions.

Operation

EMU27913

Adjusting boat trim

When the boat is on plane, a bow-up attitude results in less drag, greater stability and efficiency. This is generally when the keel line of the boat is up about 3 to 5 degrees. With the bow up, the boat may have a greater tendency to steer to one side or the other. Compensate for this as you steer. When the bow of the boat is down, it is easier to accelerate from a standing start onto plane.

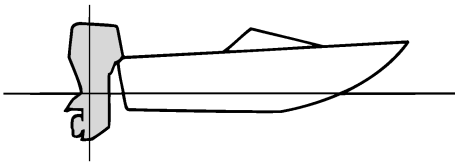

ZMU01784

Bow Up

Too much trim-out puts the bow of the boat too high in the water. Performance and economy are decreased because the hull of the boat is pushing the water and there is more air drag. Excessive trim-out can also cause the propeller to ventilate, which reduces performance further, and the boat may “porpoise” (hop in the water), which could throw the operator and passengers overboard.

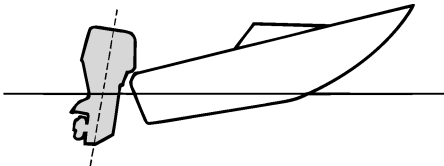

ZMU01785

Bow Down

Too much trim-in causes the boat to “plow” through the water, decreasing fuel economy and making it hard to increase speed. Operating with excessive trim-in at higher speeds also makes the boat unstable. Resistance at the bow is greatly increased, heightening the danger of “bow steering” and making operation difficult and dangerous.

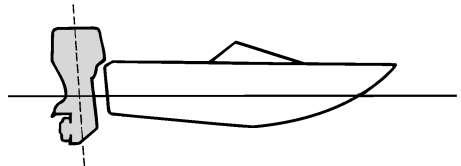

ZMU01786

TIP:

Depending on the type of boat, the outboard motor trim angle may have little effect on the trim of the boat when operating.

EMU27948

Tilting up and down

If the engine will be stopped for some time or if the boat is moored in shallows, the outboard motor should be tilted up to protect the propeller and lower case from damage by collision with obstructions, and also to reduce salt corrosion.

EWMO1544



WARNING

Make sure that all people are clear of the outboard motor when tilting the outboard motor up and down. Body parts can be crushed between the outboard motor and the clamp bracket when the outboard motor is trimmed or tilted.

ECM00993

NOTICE

- Before tilting the outboard motor, follow the procedure under “Stopping engine” in this chapter. Never tilt the outboard motor while the engine is running. Severe damage from overheating can result.
- To prevent the cooling water passages from becoming frozen when the ambient temperature is 5°C (41°F) or below, tilt the outboard motor up after it has been stopped 30 seconds or more.

EMU49410

Procedure for tilting up (power trim and tilt models)

- (1) Place the remote control lever in neutral.

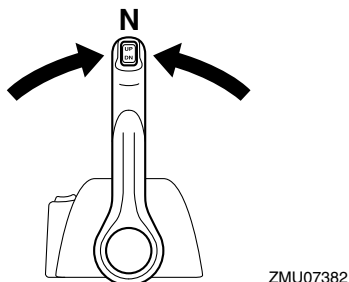
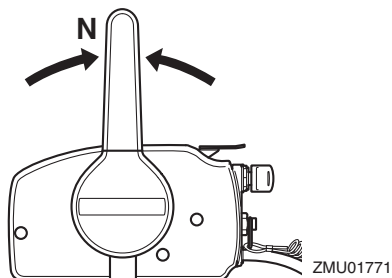

- (2) Press the power trim and tilt switch “UP” (up) until the outboard motor has tilted up completely.

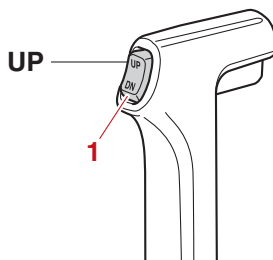

1. Power trim and tilt switch

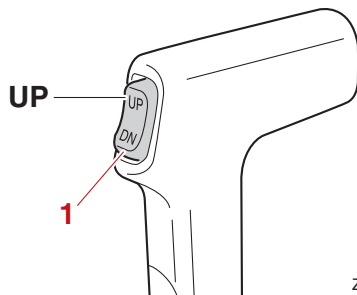

1. Power trim and tilt switch

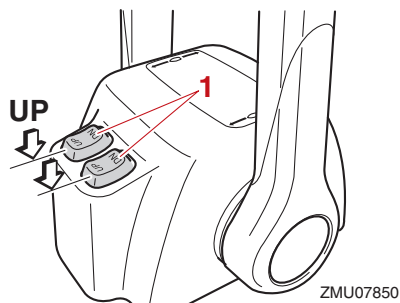

1. Power trim and tilt switch

Operation

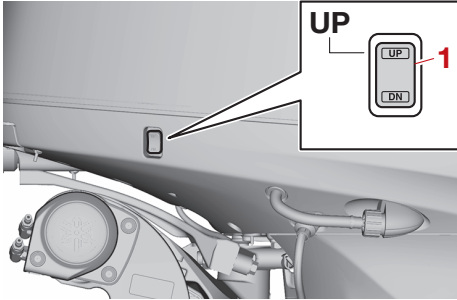

1. Power trim and tilt switch

- (3) Set the tilt support lever to support the engine. **WARNING! After tilting the outboard motor, be sure to support it with the tilt support knob or tilt support lever. Otherwise the outboard motor could fall back down suddenly if oil in the power trim and tilt unit or in the power tilt unit loses pressure.** [EWM00263] **NOTICE: Do not use the tilt support lever or knob when trailering the boat. The outboard motor could shake loose from the tilt support and fall. If the motor cannot be trailered in the normal running position, use an additional support device to secure it in the tilt position. For more detailed information, see page 73.** [ECM01642]

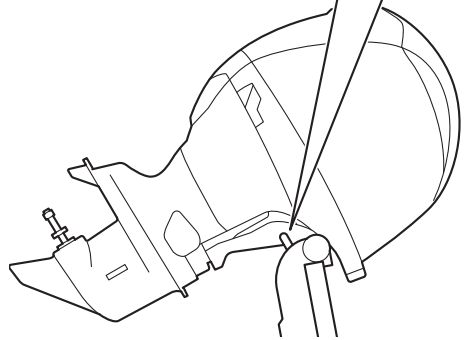
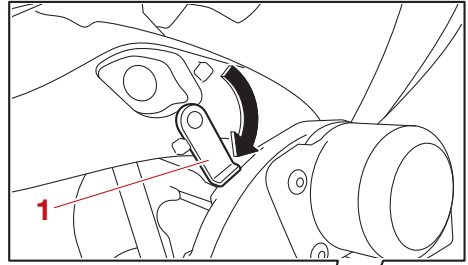

1. Tilt support lever

EMU42703

Procedure for tilting down

- (1) Push the power trim and tilt switch “UP” (up) until the outboard motor is supported by the tilt rod and the tilt support lever becomes free.
- (2) Release the tilt support lever.

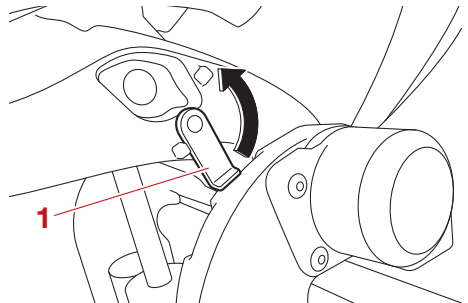

1. Tilt support lever

- (3) Push the power trim and tilt switch “DN” (down) to lower the outboard motor to the desired position.

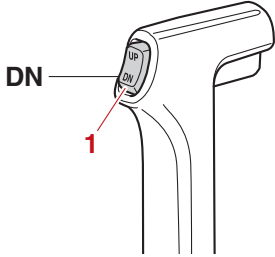

1. Power trim and tilt switch

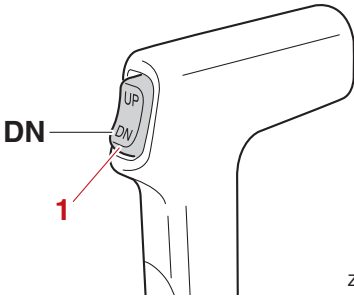

ZMU07852

1. Power trim and tilt switch

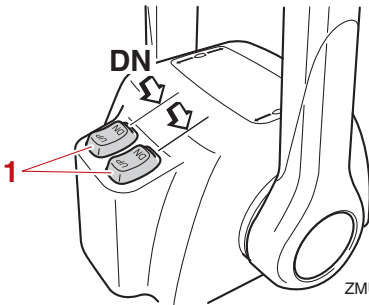

ZMU07853

1. Power trim and tilt switch

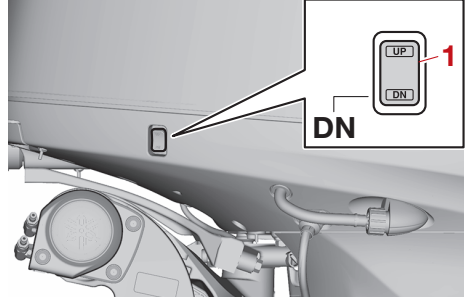

1. Power trim and tilt switch

EMU28063

Shallow water

EMU40703

Cruising in shallow water

The outboard motor can be tilted up partially to allow operation in shallow water.

ECM00261

NOTICE

Do not tilt the outboard motor up so that the cooling water inlet on the lower unit is above the surface of the water when setting up for and cruising in shallow water. Otherwise severe damage from overheating can result.

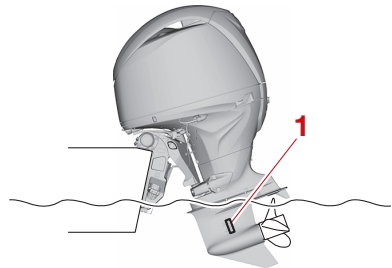

1. Cooling water inlet

EMU49351

Procedure for power trim and tilt models

- (1) Place the remote control lever in neutral.

Operation

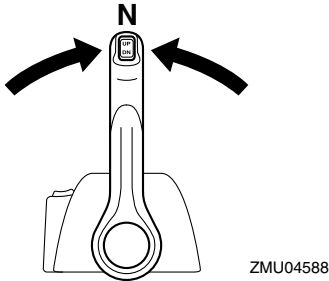
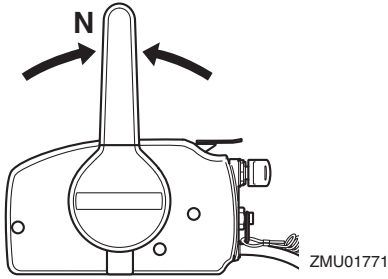

EMU28196

Cruising in other conditions

Cruising in salt water

After operating in salt water, flush the cooling water passages with fresh water to prevent them from becoming clogged. Also rinse the outside of the outboard motor with fresh water.

Cruising in muddy, turbid, or acidic water

Yamaha strongly recommends that you use the optional chromium-plated water pump kit (see page 21) if you use the outboard motor in acidic water or water with a lot of sediment in it, such as muddy or turbid (cloudy) water. After operating in such water, flush the cooling passages with fresh water to prevent corrosion. Also rinse the outside of the outboard motor with fresh water.

- (2) Slightly tilt the outboard motor up to the desired position using the power trim and tilt switch. **WARNING! Using the power trim and tilt switch on the bottom cowling while the boat is moving or engine is on could increase the risk of falling overboard and could distract the operator, increasing the risk of collision with another boat or an obstacle.** [EWM01851]
- (3) To return the outboard motor to the normal running position, press the power trim and tilt switch and slowly tilt the outboard motor down.

EMU41534

Transporting and storing outboard motor

EWM02641

WARNING

- **USE CARE** when transporting fuel tank, whether in a boat or car.
- **DO NOT** fill fuel container to maximum capacity. Gasoline will expand considerably as it warms up and can build up pressure in the fuel container. This can cause fuel leakage and a potential fire hazard.
- **Leaking fuel is a fire hazard.** Tighten securely the fuel valve when transporting and storing the outboard motor.
- **Never get under the outboard motor while it is tilted.** Severe injury could occur if the outboard motor accidentally falls.
- **Do not use the tilt support lever or knob when trailering the boat.** The outboard motor could shake loose from the tilt support and fall. If the outboard motor cannot be trailered in the normal running position, use an additional support device to secure it in the tilt position.

Leaking fuel is a fire hazard. When trailering the boat, close the fuel valve to prevent fuel from leaking.

When the outboard motor is tilted for a prolonged time for mooring or trailering the boat, make sure to follow the procedure listed below.

- Close the fuel valve.

The outboard motor should be transported and stored in the normal running position. If there is insufficient road clearance in this position, then trailer the outboard motor in the

tilted position using a motor support device such as a transom saver bar. Consult your Yamaha dealer for further details.

EMU49380

Storing outboard motor

When storing your Yamaha outboard motor for prolonged periods of time (2 months or longer), several important procedures must be performed to prevent excessive damage. It is advisable to have your outboard motor serviced by an authorized Yamaha dealer prior to storage. However, you, the owner, with a minimum of tools, can perform the following procedures.

ECM01721

NOTICE

Store the outboard motor in a dry, well-ventilated place, not in direct sunlight.

Keep the outboard motor in the attitude shown when transporting and storing it.

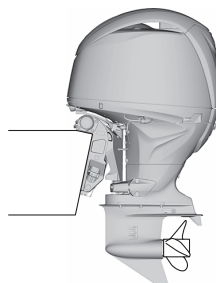

EMU41382

Conditioning and stabilizing gasoline

When preparing to store a boat for extended periods (2 months or longer) it is best to completely remove all gasoline from the boat's fuel tank(s). If it is not possible to remove the gasoline, add one ounce of "Yamalube Fuel Stabilizer & Conditioner Plus" to each gallon of gasoline in a full tank of gasoline to provide fuel stability and corrosion protection.

Maintenance

TIP:

Do not fill the fuel tank(s) to the point of overflowing. Approximately 7/8 full will allow enough space in the fuel tank to prevent gasoline purging from the fuel tank vent due to expansion with temperature changes.

Do not cap the fuel tank vent. Excessive pressure could damage the boat and motor's fuel systems.

A partially filled fuel tank, less than 7/8 full but not completely empty, is not recommended. Air space above the gasoline allows air movement which can bring in water through condensation as the air temperature changes.

Condensation inside the fuel tank can cause corrosion problems and phase separation of gasoline containing ethanol.

Consult your Yamaha dealer concerning preventative measures that may work best for the gasoline and environmental conditions in your area.

EMU28306

Procedure

EMU44313

Flushing with the flushing attachment

Cooling system flushing is essential to prevent the cooling system from clogging up with salt, sand, or dirt. In addition, fogging/lubricating of the engine is mandatory to prevent excessive engine damage due to rust. Perform the flushing and fogging at the same time.

- (1) Wash the exterior of the outboard motor using fresh water. **NOTICE: Do not spray water into the air intake.** [ECM01841]
For further information, see page 76.
- (2) Fill the fuel tank with fresh fuel and add one ounce of "Yamalube Fuel Stabilizer & Conditioner Plus" to each gallon of fuel.

TIP:

The use of "Yamalube Fuel Stabilizer & Conditioner Plus" eliminates the need to drain the fuel system. Consult your Yamaha dealer or other qualified mechanic if the fuel system is to be drained instead.

- (3) Remove the top cowling and propeller.
- (4) Install the flushing attachment over the cooling water inlet, and then turn on the water supply. **NOTICE: Do not run the engine without supplying it with cooling water. Either the engine water pump will be damaged or the engine will be damaged from overheating. Before starting the engine, be sure to supply water to the cooling water passages. Avoid running the outboard motor at high speed while on the flushing attachment, otherwise overheating could occur.** [ECM02001]

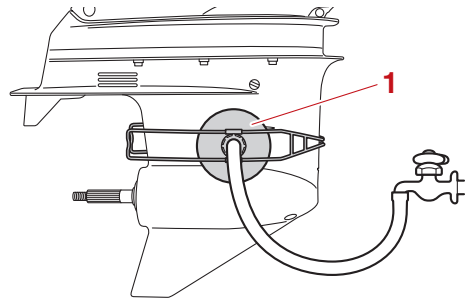

1. Flushing attachment

TIP:

A flushing attachment is available from your Yamaha dealer.

- (5) Run the engine at a fast idle for a few minutes in neutral while supplying fresh water. **WARNING! Do not touch or remove electrical parts when starting or during operation. Keep hands, hair,**

and clothes away from the flywheel and other rotating parts while the engine is running. [EWM00092]

TIP:

- When using the flushing attachment, maintain adequate water pressure so that there is a steady flow of water from the cooling water pilot hole.
 - If the overheat alert device is activated, turn the engine off, and consult your Yamaha dealer.
- (6) Just prior to turning off the engine, quickly spray “Yamaha Stor-Rite Engine Fogging Oil” into the intake silencer. When properly done, the engine will smoke excessively and almost stall.

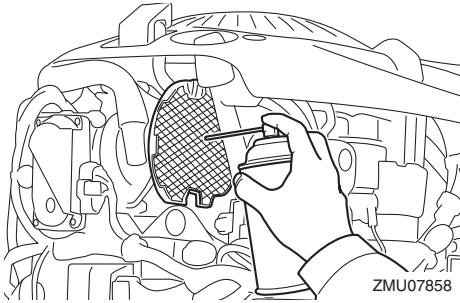

- (7) Turn off the water supply, and then remove the flushing attachment and wipe off any excess water.
- (8) Install the top cowling and propeller.
- (9) Drain the cooling water completely out of the outboard motor. Clean the exterior of the outboard motor thoroughly.

EMU41072

Lubrication

- (1) Change the gear oil. For instructions, see page 93. Check the gear oil for the presence of water that indicates a leaky seal. Seal replacement should be performed by an authorized Yamaha dealer prior to use.

- (2) Lubricate all grease fittings. For further details, see page 82.

TIP:

For long-term storage, fogging the engine with fogging oil is recommended. Contact your Yamaha dealer for information about fogging oil and procedures for your outboard motor.

EMU30269

Cleaning and anticorrosion measures

- (1) Wash down the exterior of the outboard motor with fresh water and dry off completely. **NOTICE: Do not spray water into the air intake.** [ECM01841] For further information, see page 76.
- (2) Spray the outboard motor exterior with “Yamaha Silicone Protectant”. **NOTICE: Do not spray when the engine is running. Also, do not spray near the silencer or into the engine. Otherwise the engine could be damaged.** [ECM01403]
- (3) Wax the cowling with a non-abrasive wax such as “Yamalube Professional Polish”.

EMU40964

Flushing cooling water passage

Perform this procedure right after operation for the most thorough flushing.

ECM01531

NOTICE

Do not perform this procedure while the engine is running. The water pump may be damaged and severe damage from overheating can result.

- (1) Disconnect the garden hose connector from the fitting on the bottom cowling.

Maintenance

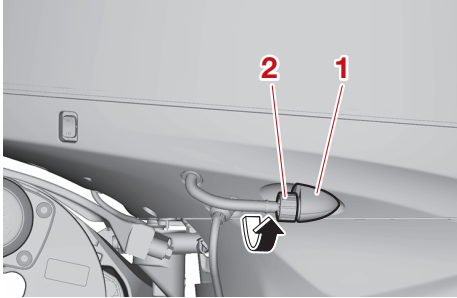

1. Fitting
2. Garden hose connector

- (2) Connect the garden hose to the garden hose connector.

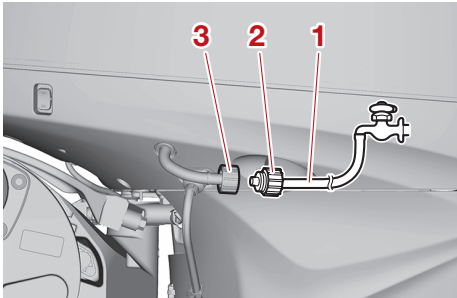

1. Garden hose
2. Garden hose adapter (commercially available)
3. Garden hose connector

- (3) With the engine off, turn on the water supply and let the water flush through the cooling water passages for about 15 minutes.
- (4) Turn off the water supply, and then disconnect the garden hose from the garden hose connector.
- (5) Connect the garden hose connector to the fitting on the bottom cowling and tighten it securely. **NOTICE: If the garden hose connector is not properly**

connected, cooling water can leak out and the engine can overheat during operation. [ECM01802]

TIP:

When flushing the cooling water passages with the boat in the water, tilting the outboard motor up until it is completely out of the water will achieve better results.

EMU44342

Cleaning the outboard motor

When cleaning the outboard motor, the top cowling must be installed.

- (1) Wash the exterior of the outboard motor using fresh water. **NOTICE: Do not spray water into the air intake.** [ECM01841]

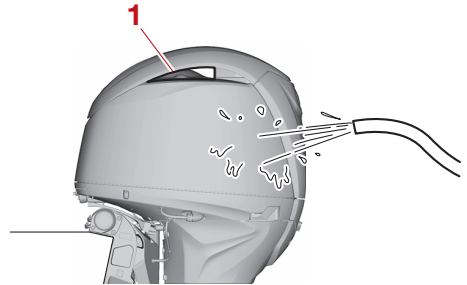

1. Air intake

- (2) Drain the cooling water completely out of the outboard motor. Clean the body thoroughly.

EMU28463

Checking painted surface of outboard motor

Check the outboard motor for scratches, nicks, or flaking paint. Areas with damaged paint are more likely to corrode. If necessary, clean and paint the areas. Touch-up paint is available from your Yamaha dealer.

EMU44952

Periodic maintenance

EWM01872



These procedures require mechanical skills, tools, and supplies. If you do not have the proper skills, tools, or supplies to perform a maintenance procedure, have a Yamaha dealer or other qualified mechanic do the work.

The procedures involve disassembling the motor and exposing dangerous parts. To reduce the risk of injury from moving, hot, or electrical parts:

- **Turn off the engine and keep the key(s) and engine shut-off cord (lanyard) with you when you perform maintenance unless otherwise specified.**
- **The power trim and tilt switches operate even when the ignition key is off. Keep people away from the switches whenever working around the motor. When the motor is tilted, keep away from the area under it or between it and the clamp bracket. Be sure no one is in this area before operating the power trim and tilt mechanism.**
- **Allow the engine to cool before handling hot parts or fluids.**
- **Always completely reassemble the motor before operation.**

Maintenance, replacement, or repair of the emission control devices and systems may be performed by any marine engine repair establishment or individual. All warranty repairs, however, including those to the emission control system, must be performed by an authorized Yamaha marine dealership.

For North America:

A service manual is available for purchase through your Yamaha dealer for owners who have the mechanical skills, tools, and other equipment necessary to perform maintenance not covered by this owner's manual.

EMU28512

Replacement parts

If replacement parts are necessary, use only genuine Yamaha parts or parts of equivalent design and quality. Any part of inferior quality may malfunction, and the resulting loss of control could endanger the operator and passengers. Yamaha genuine parts and accessories are available from your Yamaha dealer.

EMU35522

Maintenance interval guidelines

The service intervals provided in the Maintenance Chart were developed based upon "typical" use that includes operating at varied speeds, with sufficient time for engine warm up and cool-down, a medium to light load, and an average cruising speed near the 3000 to 4000 rpm range. As with any engine, however, if your normal operating conditions are different, you should consider service more often than shown, especially how often you change your engine oil and gear oil. Examples might include extended wide-open-throttle use or long periods of trolling or idling, carrying heavy loads, or frequent starting and stopping or shifting. More frequent maintenance will often pay off many times over in increased engine life and greater owner satisfaction. Consult your Yamaha dealer for additional maintenance recommendations.

Maintenance

EMU46074

Maintenance chart 1

TIP:

- Refer to the sections in this chapter for explanations of each owner-specific action.
- The maintenance cycle on these charts assume usage of 100 hours per year and regular flushing of the cooling water passages. Maintenance frequency should be adjusted when operating the engine under adverse conditions such as extended trolling.
- Disassembly or repairs may be necessary depending on the outcome of maintenance checks.
- Expendable or consumable parts and lubricants will lose their effectiveness over time and through normal usage regardless of the warranty period.
- When operating in salt water, muddy, other turbid (cloudy), acidic water, the engine should be flushed with clean water after each use.

The “●” symbol indicates the check-ups which you may carry out yourself.

The “○” symbol indicates work to be carried out by your Yamaha dealer.

Item	Actions	Initial	Every			Page
		20 hours (3 months)	100 hours (1 year)	300 hours (3 years)	500 hours (5 years)	
Anode(s) (external)	Inspection or replacement as necessary		●/○			94
Anode(s) (internal) *1	Inspection or replacement as necessary		○			—
Anode(s) (internal) *2	Replacement				○	—
Battery (electrolyte level, terminal)	Inspection	●/○	●/○			95
Battery (electrolyte level, terminal)	Fill, charging or replacing as necessary		○			—
Cooling water leakage	Inspection or replacement as necessary	○	○			—
Cowling lock lever	Inspection		●/○			56, 58
Engine starting condition/noise	Inspection	●/○	●/○			61
Engine idle speed/noise	Inspection	●/○	●/○			85
Engine oil	Replacement	●/○	●/○			85
Engine oil filter (cartridge)	Replacement		●/○			90

Maintenance

Item	Actions	Initial	Every			Page
		20 hours (3 months)	100 hours (1 year)	300 hours (3 years)	500 hours (5 years)	
Fuel filter (can be disassembled)	Inspection or replacement as necessary	●/○	●/○			57
Fuel line (High pressure)	Inspection	●	●			—
Fuel line (High pressure)	Inspection or replacement as necessary	○	○			—
Fuel line (Low pressure)	Inspection	●	●			—
Fuel line (Low pressure)	Inspection or replacement as necessary	○	○			—
Fuel pump	Inspection or replacement as necessary			○		—
Fuel/engine oil leakage	Inspection	○	○			—
Gear oil	Replacement	●/○	●/○			93
Greasing points	Greasing	●/○	●/○			82
Clamp bracket bolt (through tube)	Inspection and greasing		○			—
Impeller/water pump housing	Inspection or replacement as necessary		○			—
Impeller/water pump housing	Replacement			○		—
OCV (Oil Control Valve) filter (F200, LF200)	Replacement				○	—
Power trim and tilt unit	Inspection	●/○	●/○			59
Propeller/propeller nut/cotter pin	Inspection or replacement as necessary	●/○	●/○			91
PCV (Pressure Control Valve)	Inspection or replacement as necessary		○			—
Shift link/shift cable	Inspection, adjustment or replacement as necessary	○	○			—

Maintenance

Item	Actions	Initial	Every			Page
		20 hours (3 months)	100 hours (1 year)	300 hours (3 years)	500 hours (5 years)	
Spark plug(s)	Inspection or replacement as necessary		●/○			84
Ignition coils/ignition coil leads	Inspection or replacement as necessary	○	○			—
Shift Dampener System (SDS) propeller damper	Inspection or replacement		○			—
Water from the cooling water pilot hole	Inspection	●/○	●/○			63
Throttle link/throttle cable	Inspection, adjustment or replacement as necessary	○	○			—
Thermostat	Inspection or replacement as necessary		○			—
Timing belt	Inspection or replacement as necessary		○			—
Valve clearance	Inspection and adjustment				○	—
Cooling water inlet	Inspection	●/○	●/○			25
Main switch/stop switch	Inspection or replacement as necessary	○	○			—
Wire harness connections/wire coupler connections	Inspection or replacement as necessary	○	○			—
(Yamaha) Meter/gauge	Inspection	○	○			—
Hydraulic Steering system	Inspection or replacement as necessary	○	○	○	○	—

EMU46050

*1 exhaust cover

*2 cylinder head, crankcase cover, cooling water passage, exhaust cover

EMU46083

Maintenance chart 2

Item	Actions	Every	Page
		1000 hours	
Exhaust guide/exhaust manifold	Inspection or replacement as necessary	○	—
Timing belt	Replacement	○	—
Hydraulic Steering system	Inspection or replacement as necessary	○	—

Maintenance

EMU41303

Greasing

Yamalube Marine Grease

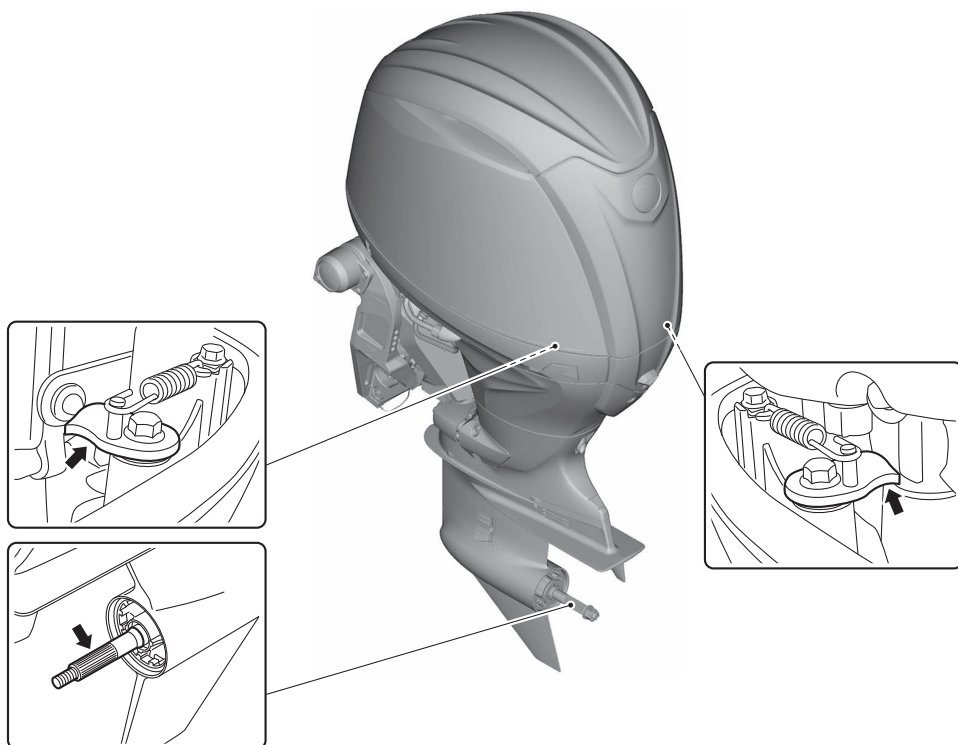

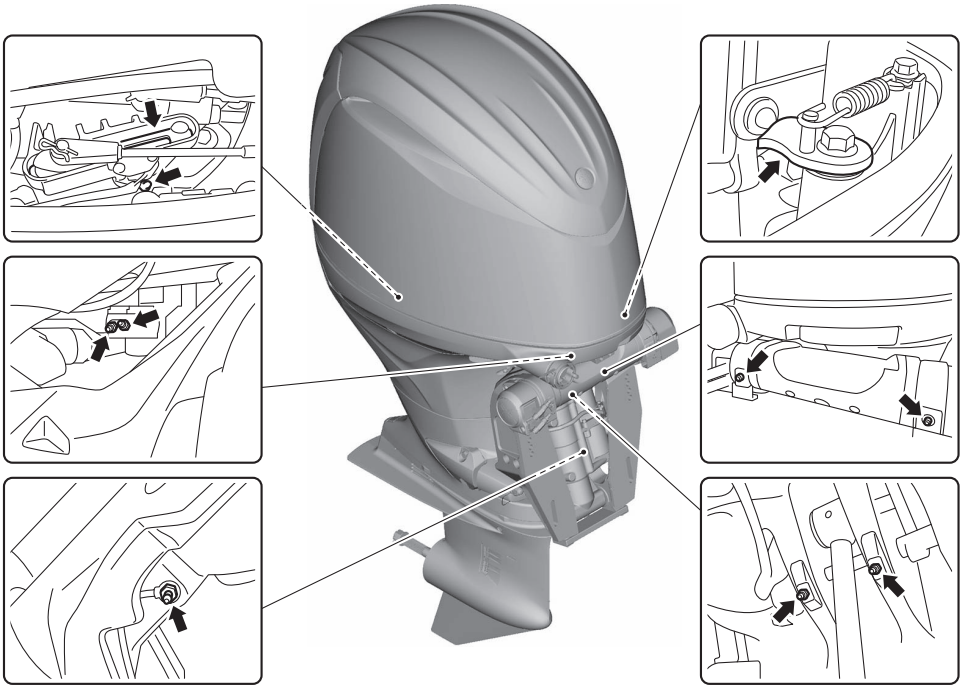

Maintenance

EMU44333

Inspecting spark plug

The spark plug is an important engine component. The condition of the spark plug can indicate something about the condition of the engine. For example, if the center electrode porcelain is very white, this could indicate an intake air leak or carburetion problem in that cylinder. Do not attempt to diagnose any problems yourself. Instead, take the outboard motor to a Yamaha dealer. You should periodically remove and check the spark plug because heat and deposits will cause the spark plug to slowly break down and erode.

To remove the spark plug

- (1) Remove the ignition coil cover.

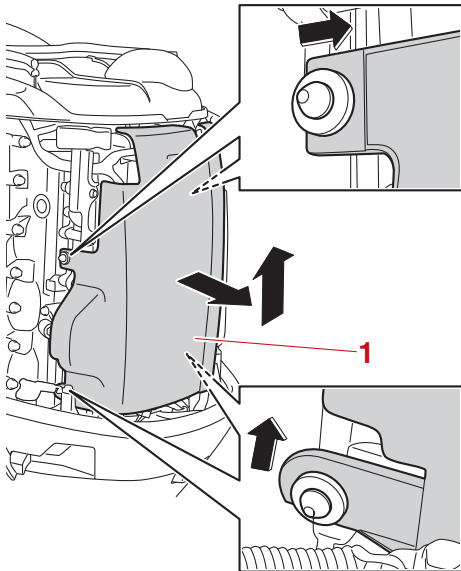

1. Ignition coil cover
- (2) Remove the bolt that is securing the ignition coil, and then remove the ignition coil. **NOTICE:** Do not use any tools to

remove or install the ignition coil. Otherwise, the ignition coil coupler could be damaged. [ECM02331]

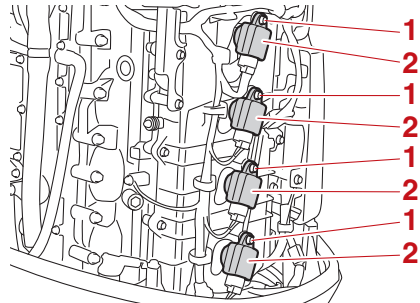

1. Bolt
2. Ignition coil

- (3) Remove the spark plug. **WARNING!** When removing or installing a spark plug, be careful not to damage the insulator. A damaged insulator could allow external sparks, which could lead to explosion or fire. [EWM00562]

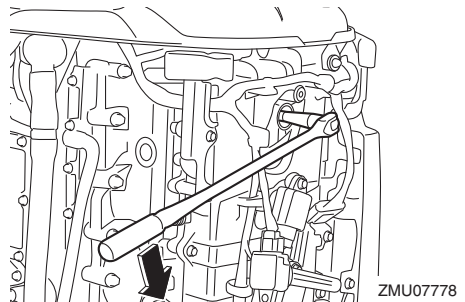

To check the spark plug

- (1) Check the condition of the spark plug. If electrode erosion becomes excessive or carbon and other deposits are excessive, replace the spark plug with the specified plug.

Standard spark plug:
LFR6A-11

- (2) Measure the spark plug gap using a thickness gauge. If the spark plug gap is out of specification, replace the spark plug with the specified plug.

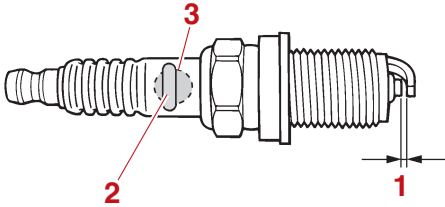

ZMU01797

1. Spark plug gap
2. Spark plug part number
3. Spark plug I.D. mark (NGK)

Spark plug gap:

1.0–1.1 mm (0.039–0.043 in)

To install the spark plug

- (1) Wipe off any dirt from the threads, insulator, and gasket surface of the spark plug.
- (2) Install the spark plug, and then tighten it to the specified torque.

Spark plug tightening torque:

28 N·m (2.8 kgf·m, 21 lb·ft)

TIP:

If a torque-wrench is not available when you are reinstalling a spark plug, a good estimate of the correct torque is 1/12 turn past finger-tight. When you are installing a new spark plug, a good estimate of the correct torque is 1/2 to 2/3 turn past finger-tight.

- (3) Install the ignition coil, and then tighten the bolt to the specified torque.

Bolt tightening torque:

8 N·m (0.8 kgf·m, 5.9 lb·ft)

- (4) Install the ignition coil cover.

EMU29045

Inspecting idle speed

EWM00452



- Do not touch or remove electrical parts when starting or during operation.
- Keep hands, hair, and clothes away from the flywheel and other rotating parts while the engine is running.

ECM00491

NOTICE

This procedure must be performed while the outboard motor is in the water. A flushing attachment or test tank can be used.

If the boat is not equipped with a tachometer for the outboard motor, use a diagnostic tachometer for this procedure. Results may vary depending on whether testing is conducted with the flushing attachment, in a test tank, or with the outboard motor in the water.

- (1) Start the engine and allow it to warm up fully in neutral until it is running smoothly.
- (2) Once the engine has warmed up, verify whether the idle speed is set to specification. For idle speed specifications, see page 15. If you have difficulty verifying the idle speed, or the idle speed requires adjustment, consult a Yamaha dealer or other qualified mechanic.

EMU44475

Changing engine oil

EWM00761



- Avoid draining the engine oil immediately after stopping the engine. The oil is hot and should be handled with care to avoid burns.

Maintenance

- Be sure the outboard motor is securely fastened to the transom or a stable stand.

ECM01711

NOTICE

Change the engine oil after the first 20 hours of operation or 3 months, and every 100 hours or at 1-year intervals thereafter. Otherwise the engine will wear quickly.

To prevent spilling oil where it could cause damage to nature, it is strongly recommended that you use an oil changer to change the engine oil. If an oil changer is not available, drain the engine oil by removing the drain screw. If you are not familiar with the procedure for changing the engine oil, consult your Yamaha dealer.

Changing the engine oil using an oil changer (recommended)

- (1) Put the outboard motor in an upright position (not tilted). **NOTICE: If the outboard motor is not level, the oil level indicated on the oil dipstick may not be accurate.** [ECM01862]

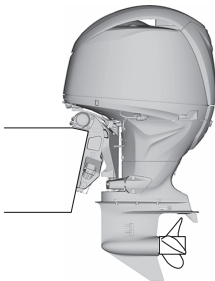

- (2) Start the engine. Warm it up and keep the idle speed for 5-10 minutes.
- (3) Stop the engine and leave it for 5-10 minutes.
- (4) Remove the top cowling.
- (5) Remove the oil filler cap.

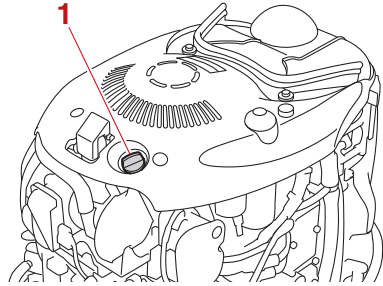

1. Oil filler cap

- (6) Remove the oil dipstick.
- (7) Insert the tube of the oil changer into the oil dipstick guide, and then extract the engine oil completely.

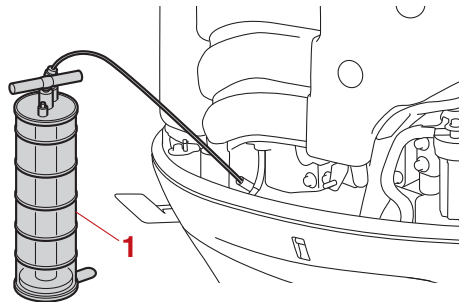

1. Oil changer

- (8) Add the correct amount of oil through the filler hole. Put back the filler cap and the dipstick. **NOTICE: Overfilling the oil could cause leakage or damage. If the oil level is above the upper level mark, drain until the level meets the specified capacity.** [ECM01851]

Recommended engine oil:

YAMALUBE 4M FC-W or 4-stroke outboard motor oil

Engine oil quantity (without oil filter replacement):

4.3 L (4.55 US qt, 3.78 Imp.qt)

Engine oil quantity (with oil filter replacement):

4.5 L (4.76 US qt, 3.96 Imp.qt)

- (9) Leave the outboard motor for 5-10 minutes.
- (10) Remove the oil dipstick and wipe it clean.
- (11) Insert the dipstick and remove it again. Be sure to completely insert the dipstick into the dipstick guide, otherwise the oil level measurement will be incorrect.
- (12) Recheck the oil level using the dipstick to be sure the level falls between the upper and lower marks. Consult your Yamaha dealer if the oil level is out of specified level.

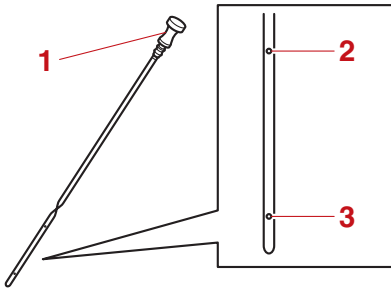

1. Oil dipstick
2. Upper mark
3. Lower mark

- (13) Start the engine and make sure that the low oil pressure-alert indicator remains off. Also, make sure that there are no oil leaks. **NOTICE: If the low oil pressure-alert indicator comes on or if there are oil leaks, stop the engine and find the cause. Continued operation with a problem could cause severe engine damage. Consult your Yamaha dealer if the problem cannot be located and corrected.** [ECM01623]
- (14) Install the top cowling.
- (15) Dispose of used oil according to local regulations.

TIP:

- For more information on the disposal of used oil, consult your Yamaha dealer.
- Change the oil more often when operating the engine under adverse conditions such as extended trolling.

Changing the engine oil by draining the oil

The location of the drain screw is different for L transom models and X transom models. For L transom models, skip steps 5 and 14 because the apron does not have to be removed.

L transom models

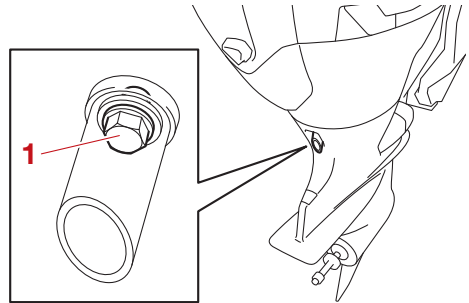

1. Drain screw

X transom models

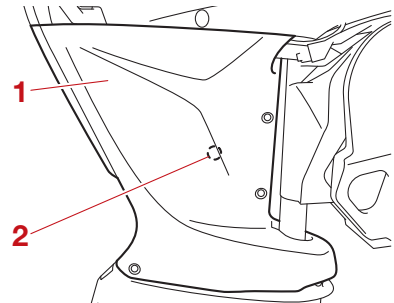

1. Apron
2. Drain screw

- (1) Put the outboard motor in an upright position (not tilted). **NOTICE: If the outboard motor is not level, the oil level indicated on the oil dipstick may not be accurate.** [ECM01862]

Maintenance

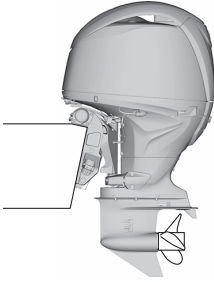

- (2) Start the engine. Warm it up and keep the idle speed for 5-10 minutes.
- (3) Stop the engine and leave it for 5-10 minutes.
- (4) Remove the top cowling.
- (5) Remove the bolts and screw to remove the apron from the starboard side.

X transom models

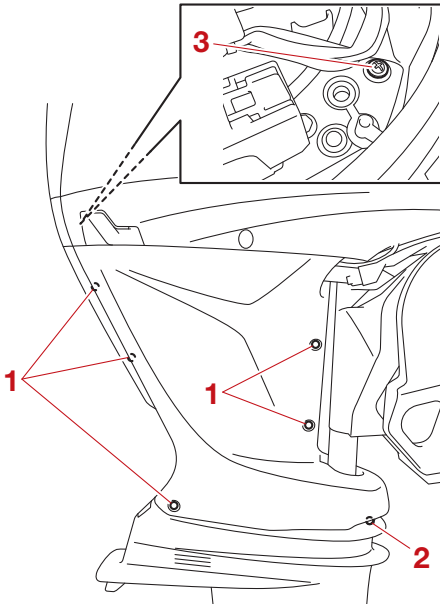

1. Bolt
2. Bolt
3. Screw

- (6) Remove the oil filler cap.

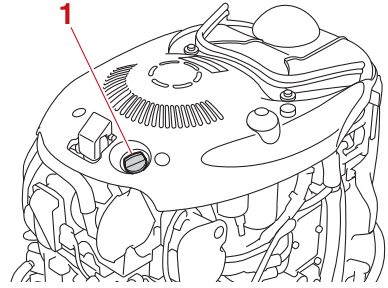

1. Oil filler cap
- (7) Prepare a suitable container that holds a larger amount than the engine oil capacity. Remove the drain screw and gasket while holding the container under the drain hole. Let the oil drain completely. Wipe up any spilled oil immediately.

L transom models

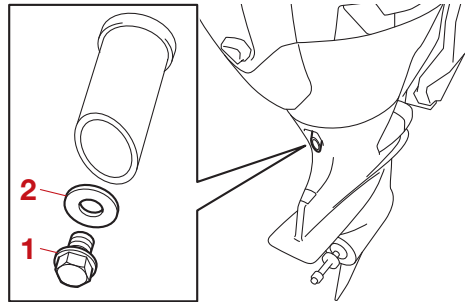

1. Drain screw
2. Gasket

X transom models

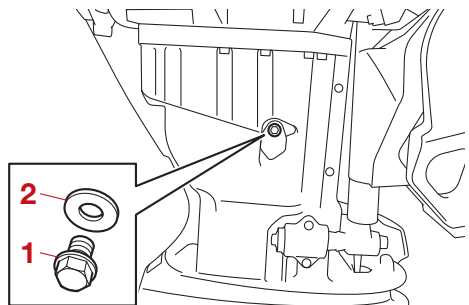

1. Drain screw

2. Gasket

TIP:

If the oil does not drain easily, change the tilt angle or turn the outboard motor to port and starboard to drain the oil.

- (8) Put a new gasket on the drain screw. Apply a light coat of oil to the gasket and install the drain screw.

Drain screw tightening torque:

27 N·m (2.7 kgf·m, 20 lb·ft)

TIP:

If a torque wrench is not available when you are installing the drain screw, finger tighten the screw just until the gasket comes into contact with the surface of the drain hole. Then tighten 1/4 to 1/2 turn more. Tighten the drain screw to the correct torque with a torque wrench as soon as possible.

- (9) Add the correct amount of oil through the filler hole. Put back the filler cap and the dipstick. **NOTICE: Overfilling the oil could cause leakage or damage. If the oil level is above the upper level mark, drain until the level meets the specified capacity.** [ECM01851]

Recommended engine oil:

YAMALUBE 4M FC-W or 4-stroke outboard motor oil

Engine oil quantity (without oil filter replacement):

4.3 L (4.55 US qt, 3.78 Imp.qt)

Engine oil quantity (with oil filter replacement):

4.5 L (4.76 US qt, 3.96 Imp.qt)

- (10) Leave the outboard motor for 5-10 minutes.
- (11) Remove the oil dipstick and wipe it clean.

- (12) Insert the dipstick and remove it again. Be sure to completely insert the dipstick into the dipstick guide, otherwise the oil level measurement will be incorrect.

- (13) Recheck the oil level using the dipstick to be sure the level falls between the upper and lower marks. Consult your Yamaha dealer if the oil level is out of specified level.

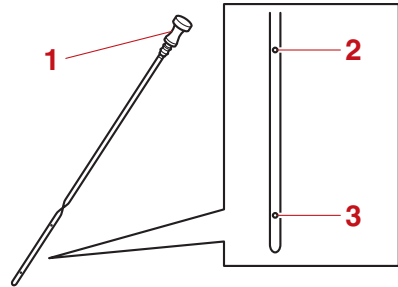

1. Oil dipstick
2. Upper mark
3. Lower mark

- (14) Start the engine and make sure that the low oil pressure-alert indicator remains off. Also, make sure that there are no oil leaks. **NOTICE: If the low oil pressure-alert indicator comes on or if there are oil leaks, stop the engine and find the cause. Continued operation with a problem could cause severe engine damage. Consult your Yamaha dealer if the problem cannot be located and corrected.** [ECM01623]

- (15) Apply LOCTITE 572 to the threads of the bolts and screw, and then install the apron.

TIP:

LOCTITE 572 is used as a sealant.

- (16) Install the top cowling.
- (17) Dispose of used oil according to local regulations.

Maintenance

TIP:

- For more information on the disposal of used oil, consult your Yamaha dealer.
- Change the oil more often when operating the engine under adverse conditions such as extended trolling.

EMU48110

Replacing the engine oil filter

EWM00761

WARNING

- **Avoid draining the engine oil immediately after stopping the engine. The oil is hot and should be handled with care to avoid burns.**
- **Be sure the outboard motor is securely fastened to the transom or a stable stand.**

Yamaha recommends you to have a Yamaha dealer replace the engine oil filter.

If you perform replacement yourself, follow the procedure below. If you have any questions, please consult a Yamaha dealer.

- (1) Drain the engine oil. For further information, see page 85.
- (2) Place a cloth under the engine oil filter.
- (3) Turn the engine oil filter counterclockwise and remove it.

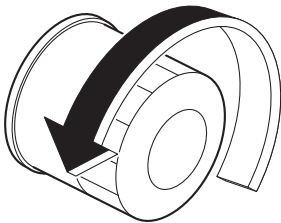

TIP:

- Wipe up any spilled engine oil.

- Dispose of the removed engine oil filter in accordance with local regulations.
- (4) Apply engine oil to the O-ring of the engine oil filter.

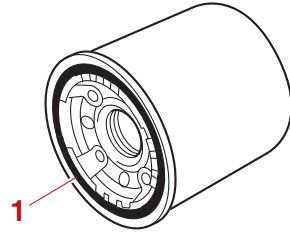

1. O-ring

- (5) Turn the engine oil filter clockwise and tighten it to the specified torque.

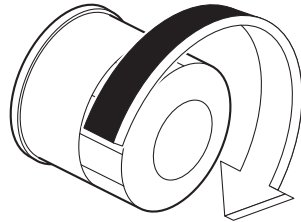

Engine oil filter:

18 N·m (1.8 kgf·m, 13 lb·ft)

- (6) Fill up the engine with engine oil. For further information, see page 85.

EMU48060

Why Yamalube

YAMALUBE oil is a Genuine YAMAHA Part born of the engineers' passion and belief that engine oil is an important liquid engine component. We form teams of specialists in the fields of mechanical engineering, chemistry, electronics and track testing, and have them

develop the engine together with the oil it will use. Yamalube oils take full advantage of the base oil's qualities and blend in the ideal balance of additives to make sure the final oil clears our performance standards. Thus, Yamalube mineral, semisynthetic and synthetic oils have their own distinct characters and value. Yamaha's experience gained over many years of research and development into oil since the 1960's helps make Yamalube the best choice for your Yamaha engine.



EMU29116

Inspecting wiring and connectors

- Inspect that each connector is engaged securely.
- Inspect that each ground lead is properly secured.

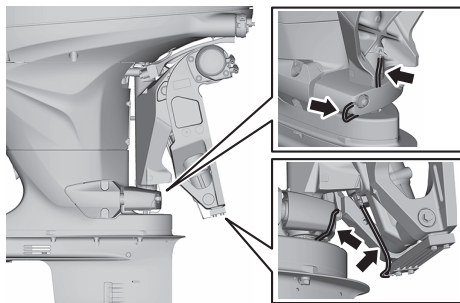

EMU40892

Inspecting propeller

EWM02562



You could be seriously injured if the engine accidentally starts when you are near the propeller. Before inspecting, removing, or installing the propeller, move the remote control lever to the neutral position, turn the main switch to the "OFF" (off) position, remove the key, and remove the clip from the engine shut-off switch. Turn off the battery cut-off switch if your boat has one.

Do not use your hand to hold the propeller when loosening or tightening the propeller nut. Place a block of wood between the anti-cavitation plate and the propeller to prevent the propeller from turning.

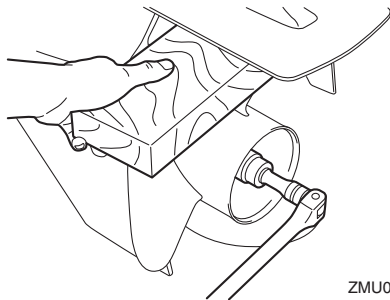

ZMU07854

Checkpoints

- Check each of the propeller blades for erosion from cavitation or ventilation, and other damage.
- Check the propeller shaft for damage.
- Check the splines for wear and damage.
- Check for fish line tangled around the propeller shaft.

Maintenance

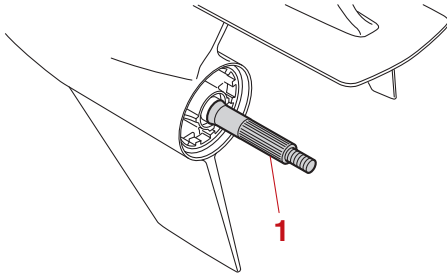

1. Propeller shaft

EMU42632

Removing propeller

- (1) Straighten the cotter pin and pull it out using a pair of pliers.
- (2) Remove the propeller nut, washer, and spacer. **WARNING! Do not use your hand to hold the propeller when loosening the propeller nut.** [EWM01891]

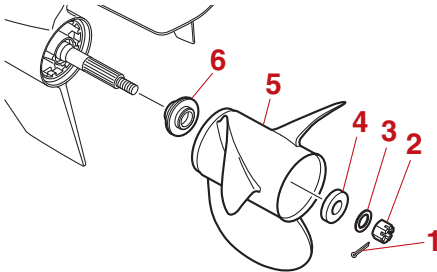

1. Cotter pin
2. Propeller nut
3. Washer
4. Spacer
5. Propeller
6. Thrust washer

- (3) Remove the propeller, spacer (if equipped), and thrust washer.

EMU41963

Installing propeller

EWM00771



WARNING

On counter rotation models, be sure to use a propeller intended for counterclockwise rotation. These propellers are identified with the letter "L" after the size indication on the propeller. Otherwise the boat could move in the opposite direction from that expected.

ECM00502



NOTICE

Make sure to use a new cotter pin and bend the ends over securely. Otherwise, the propeller could come off during operation and be lost.

- (1) Apply Yamalube Marine Grease to the propeller shaft.
- (2) Install the thrust washer and propeller on the propeller shaft. **NOTICE: Make sure to install the thrust washer before installing the propeller. Otherwise, the lower case and propeller boss could be damaged.** [ECM01882]
- (3) Install the spacer, washer, and propeller nut. Tighten the propeller nut to the specified torque.

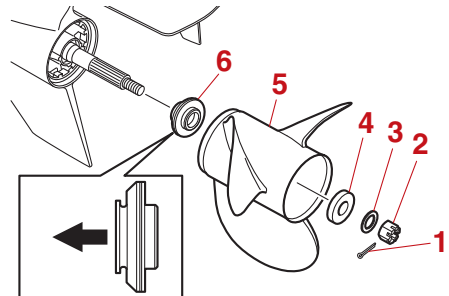

1. Cotter pin
2. Propeller nut
3. Washer

4. Spacer
5. Propeller
6. Thrust washer

Propeller nut tightening torque:
54 N·m (5.4 kgf·m, 40 lb·ft)

- (4) Align the propeller nut slot with the propeller shaft hole. Insert a new cotter pin in the hole and bend the cotter pin ends.
NOTICE: Do not reuse the cotter pin. Otherwise, the propeller can come off during operation. [ECM01892]

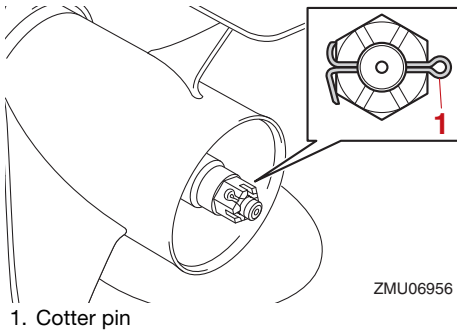

TIP:

If the propeller nut slot does not align with the propeller shaft hole after tightening the propeller nut to the specified torque, tighten the nut further to align the slot with the hole.

EMU47101

Changing gear oil

EWM00801



- Be sure the outboard motor is securely fastened to the transom or a stable stand. You could be severely injured if the outboard motor falls on you.

- Never get under the lower unit while it is tilted, even when the tilt support lever or knob is locked. Severe injury could occur if the outboard motor accidentally falls.

- (1) Tilt the outboard motor so that the gear oil drain screw is at the lowest point possible.
- (2) Place a suitable container under the lower unit.
- (3) Remove the gear oil drain screw and gasket.

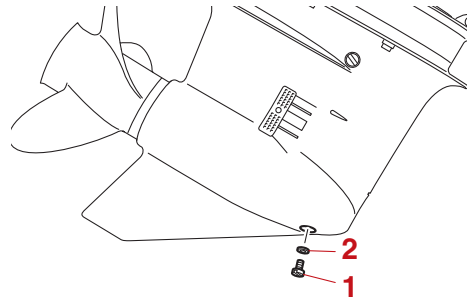

1. Gear oil drain screw
2. Gasket

TIP:

Always use new gasket. Do not reuse the removed gasket.

- (4) Remove the oil level plug and gasket to allow the oil to drain completely.
NOTICE: Check the used gear oil after it has been drained. If the gear oil is milky or contains water or a large amount of metal particles, the gear case may be damaged. Have a Yamaha dealer check and repair the outboard motor. [ECM00714]

Maintenance

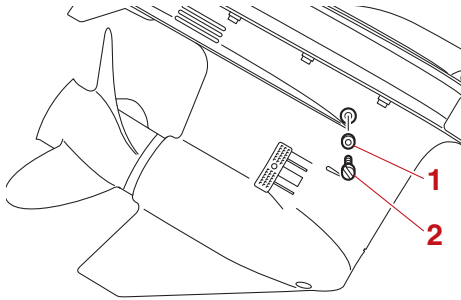

1. Gasket
2. Oil level plug

TIP:

For disposal of used gear oil, consult your Yamaha dealer.

- (5) Remove any metal particles on the magnetic gear oil drain screw. **NOTICE: If there is an excessive quantity of metal particles on the magnetic gear oil drain screw, this can indicate lower unit problem. Consult your Yamaha dealer.** [ECM01901]
- (6) Put the outboard motor in a vertical position.
- (7) Using a flexible or pressurized filling device, inject the gear oil into the gear oil drain screw hole.

Recommended gear oil:

Yamalube Marine Gearcase Lube HD or Hypoid gear oil

Recommended gear oil grade:

SAE 90 API GL-4 / SAE 80W API GL-5 / SAE 90 API GL-5

Gear oil quantity:

0.980 L (1.036 US qt, 0.862 Imp.qt)

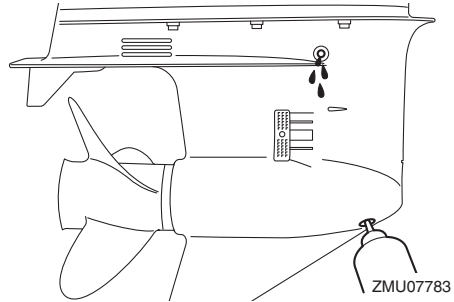

- (8) Put a new gasket on the oil level plug. When the gear oil begins to flow out of the oil level plug hole, insert and tighten the oil level plug to the specified torque.

TIP:

Apply a light coat of gear oil to the oil level plug thread and gasket before installation.

Tightening torque:

7 N·m (0.7 kgf·m, 5.2 lb·ft)

- (9) Put a new gasket on the gear oil drain screw. Insert and tighten the gear oil drain screw to the specified torque.

TIP:

Apply a light coat of gear oil to the gear oil drain screw thread and gasket before installation.

Tightening torque:

7 N·m (0.7 kgf·m, 5.2 lb·ft)

EMU29318

Inspecting and replacing anode(s)

Yamaha outboard motors are protected from corrosion by sacrificial anodes. Inspect the external anodes periodically. Remove scales from the surfaces of the anodes. Consult a Yamaha dealer for replacement of external anodes.

ECM00721

NOTICE

Do not paint anodes, as this would render them ineffective.

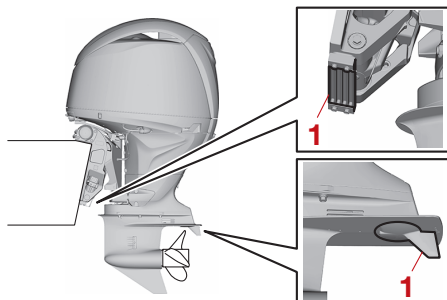

1. Anode

TIP:

Inspect ground leads attached to external anodes on equipped models. Consult a Yamaha dealer for inspection and replacement of internal anodes attached to the power unit.

EMU29324

Checking battery (for electric start models)

EWM01903



WARNING

Battery electrolyte is poisonous and caustic, and batteries generate explosive hydrogen gas. When working near the battery:

- Wear protective eye gear and rubber gloves.
- Do not smoke or bring any other source of ignition near the battery.

The procedure for checking the battery varies for different batteries. This procedure contains typical checks that apply to many batteries, but you should always refer to the battery manufacturer's instructions.

ECM01921

NOTICE

A poorly maintained battery will quickly deteriorate.

- (1) Check the electrolyte level.

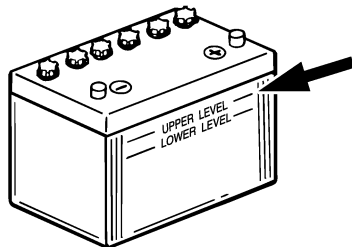

ZMU01810

- (2) Check the battery's charge. If your boat is equipped with the digital speedometer, the voltmeter and low battery alert functions will help you monitor the battery's charge. If the battery needs charging, consult your Yamaha dealer.
- (3) Check the battery connections. They should be clean, secure, and covered by an insulating cover. **WARNING! Bad connections can produce shorting or arcing and cause an explosion.** [EWM01913]

EMU35497

Connecting the battery

EWM00573



WARNING

Mount the battery holder securely in a dry, well-ventilated, vibration-free location in the boat. Install a fully charged battery in the holder.

ECM01125

NOTICE

Do not reverse the battery cables. Otherwise, the electrical parts could be damaged.

Maintenance

- (1) Make sure the main switch (on applicable models) is turned to the "OFF" (off) position before working on the battery.
- (2) Connect the positive battery cable (red) to the positive (+) terminal first. Then, connect the negative battery cable (black) to the negative (-) terminal.

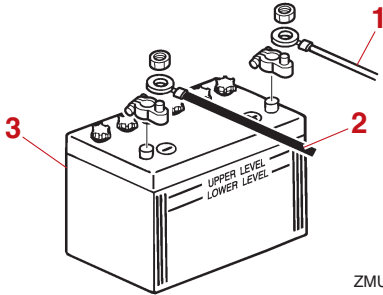

ZMU01811

1. Red cable
2. Black cable
3. Battery

- (3) The electrical contacts of the battery and cables must be clean and properly connected, or the battery will not start the engine.

Connecting an accessory battery (optional)

If connecting an accessory battery, consult your Yamaha dealer about correct wiring. For the fuse size, see ABYC (E-11).

Single engine

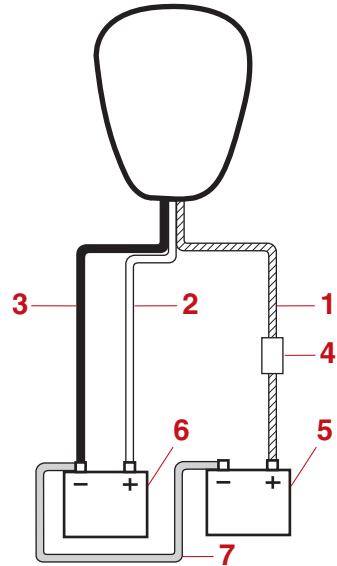

1. Isolator leads with circuit protection
2. Red cable
3. Black cable
4. Fuse
5. Battery for accessories
6. Battery for starting
7. Negative connecting cable

Twin engines

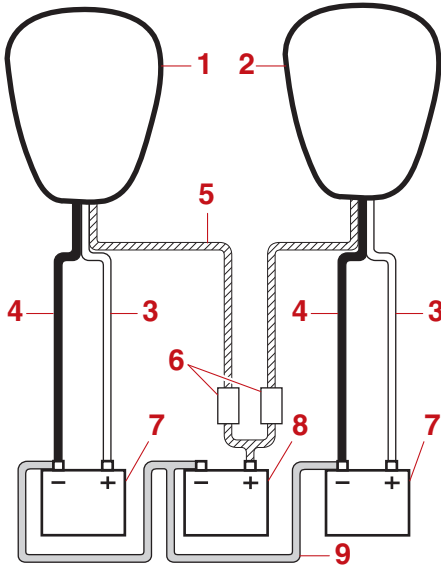

- (4) Clean, maintain, and store the battery according to the manufacturer's instructions.

1. Starboard side engine
2. Port side engine
3. Red cable
4. Black cable
5. Isolator leads with circuit protection
6. Fuse
7. Battery for starting
8. Battery for accessories
9. Negative connecting cable

EMU29372

Disconnecting the battery

- (1) Turn off the battery cut-off switch (if equipped) and main switch. **NOTICE: If they are left on, the electrical system can be damaged.** [ECM01931]
- (2) Disconnect the negative cable(s) from the negative (-) terminal. **NOTICE: Always disconnect all negative (-) cables first to avoid a short circuit and damage to the electrical system.** [ECM01941]
- (3) Disconnect the positive cable(s) and remove the battery from the boat.

Trouble Recovery

EMU44361

Troubleshooting

This section describes the likely causes and remedies for problems, such as those in the fuel, compression, and ignition systems, poor starting, and loss of power. Please note that all of the items in this section may not apply to your model.

If your outboard motor requires repair, bring it to a Yamaha dealer.

If the engine trouble-alert indicator is blinking, consult your Yamaha dealer.

Starter will not operate.

Q. Is remote control lever in gear?

A. Shift to neutral.

Q. Is battery capacity low or weak?

A. Check battery condition. Use battery of recommended capacity.

Q. Are battery connections corroded or loose?

A. Tighten battery cables and clean battery terminals.

Q. Is fuse for starter relay or electric circuit blown?

A. Check for cause of electric overload and repair. Replace fuse with one of correct amperage.

Q. Are starter components malfunctioning?

A. Have serviced by a Yamaha dealer.

Engine will not start (starter operates).

Q. Is clip on engine shut-off cord (lanyard) installed?

A. Install clip to engine shut-off switch.

Q. Is fuel tank empty?

A. Fill tank with clean, fresh fuel.

Q. Is fuel contaminated or stale?

A. Fill tank with clean, fresh fuel.

Q. Is fuel filter clogged?

A. Clean or replace fuel filter.

Q. Is starting procedure incorrect?

A. See page 61.

Q. Is fuel pump malfunctioning?

A. Have serviced by a Yamaha dealer.

Q. Are spark plugs fouled or of incorrect type?

A. Inspect spark plugs. Clean or replace with recommended type.

Q. Are ignition parts malfunctioning?

A. Have serviced by a Yamaha dealer.

Q. Is ignition wiring damaged or poorly connected?

A. Inspect wires for breaks and wear. Have connections tightened and broken or worn wires replaced by a Yamaha dealer.

Q. Are engine inner parts damaged?

A. Have serviced by a Yamaha dealer.

Engine idles irregularly or stalls.

Q. Are spark plugs fouled or of incorrect type?

A. Inspect spark plugs. Clean or replace with recommended type.

Q. Is fuel system clogged?

A. Inspect for pinched or kinked fuel line or other obstructions in fuel system.

Trouble Recovery

Q. Is fuel contaminated or stale?

A. Fill tank with clean, fresh fuel.

Q. Is fuel filter clogged?

A. Clean or replace fuel filter.

Q. Are ignition parts malfunctioning?

A. Have serviced by a Yamaha dealer.

Q. Has alert system activated?

A. Find and correct cause of alert.

Q. Is spark plug gap incorrect?

A. Replace spark plug.

Q. Is ignition wiring damaged or poorly connected?

A. Inspect wires for breaks and wear. Have connections tightened and broken or worn wires replaced by a Yamaha dealer.

Q. Is specified engine oil not being used?

A. Inspect engine oil and replace with specified type.

Q. Is thermostat clogged or malfunctioning?

A. Have serviced by a Yamaha dealer.

Q. Is fuel pump malfunctioning?

A. Have serviced by a Yamaha dealer.

Q. Is fuel tank air vent restricted or clogged?

A. Remove obstruction.

Q. Is outboard motor angle too high?

A. Return to normal operating position.

Q. Is fuel joint connection incorrect?

A. Connect correctly.

Q. Is throttle cable adjustment incorrect?

A. Have serviced by a Yamaha dealer.

Q. Is battery cable disconnected?

A. Connect securely.

Alert buzzer sounds or indicator lights.

Q. Is cooling system clogged?

A. Inspect cooling water inlet for obstructions.

Q. Is low oil pressure-alert indicator on or blinking?

A. Have serviced by a Yamaha dealer.

Q. Is heat range of spark plugs incorrect?

A. Inspect spark plugs and replace with recommended type.

Q. Is specified engine oil not being used?

A. Inspect engine oil and replace with specified type.

Q. Is engine oil contaminated or deteriorated?

A. Replace engine oil with specified type.

Q. Is oil filter clogged?

A. Have serviced by a Yamaha dealer.

Q. Is oil pump malfunctioning?

A. Have serviced by a Yamaha dealer.

Q. Is load on boat improperly distributed?

A. Distribute load to place boat on an even plane.

Q. Is thermostat or water pump malfunctioning?

A. Have serviced by a Yamaha dealer.

Q. Is there excess water in fuel filter?

Trouble Recovery

A. Drain fuel filter.

Engine power loss.

Q. Is propeller damaged?

A. Have propeller repaired or replaced.

Q. Is propeller pitch or diameter incorrect?

A. Install correct propeller to operate outboard motor at its recommended speed (r/min) range.

Q. Is outboard motor mounted at incorrect height on transom?

A. Have outboard motor adjusted to proper transom height.

Q. Has alert system activated?

A. Find and correct cause of alert.

Q. Is boat bottom fouled with marine growth?

A. Clean boat bottom.

Q. Are spark plugs fouled or of incorrect type?

A. Inspect spark plugs. Clean or replace with recommended type.

Q. Are weeds or other foreign material tangled on gear housing?

A. Remove foreign material and clean lower unit.

Q. Is fuel system clogged?

A. Inspect for pinched or kinked fuel line or other obstructions in fuel system.

Q. Is fuel filter clogged?

A. Clean or replace fuel filter.

Q. Is fuel contaminated or stale?

A. Fill tank with clean, fresh fuel.

Q. Is spark plug gap incorrect?

A. Replace spark plug.

Q. Is ignition wiring damaged or poorly connected?

A. Inspect wires for breaks and wear. Have connections tightened and broken or worn wires replaced by a Yamaha dealer.

Q. Are electrical parts malfunctioning?

A. Have serviced by a Yamaha dealer.

Q. Is specified fuel not being used?

A. Replace fuel with specified type.

Q. Is specified engine oil not being used?

A. Replace engine oil with specified type.

Q. Is thermostat clogged or malfunctioning?

A. Have serviced by a Yamaha dealer.

Q. Is fuel tank air vent restricted or clogged?

A. Remove obstruction.

Q. Is fuel pump malfunctioning?

A. Have serviced by a Yamaha dealer.

Q. Is fuel joint connection incorrect?

A. Connect correctly.

Q. Is heat range of spark plugs incorrect?

A. Inspect spark plugs and replace with recommended type.

Q. Is engine not responding properly to remote control lever position?

A. Have serviced by a Yamaha dealer.

Engine vibrates excessively.

Trouble Recovery

- Q. Is propeller damaged?
A. Have propeller repaired or replaced.
- Q. Is propeller shaft damaged?
A. Have serviced by a Yamaha dealer.
- Q. Are weeds or other foreign material tangled on propeller?
A. Remove and clean propeller.
- Q. Are outboard motor mounting bolts loose?
A. Tighten bolts or have serviced by a Yamaha dealer.
- Q. Is steering pivot loose or damaged?
A. Have serviced by a Yamaha dealer.

EMU29436

Temporary action in emergency

EMU29442

Impact damage

EWM00871



The outboard motor can be seriously damaged by a collision while operating or trailering. Damage could make the outboard motor unsafe to operate.

If the outboard motor hits an object in the water, follow the procedure below.



- (1) Stop the engine immediately.

- (2) Check the control system and all components for damage. Also, check the boat for damage.
- (3) Whether damage is found or not, return to the nearest harbor slowly and carefully.
- (4) Have a Yamaha dealer check the outboard motor before operating it again.

EMU29454

Running single engine (twin engines)

When using only one engine in an emergency, be sure to keep the unused one tilted up and operate the other engine at low speed.

ECM00371

NOTICE

If the boat is operated with one engine in the water but not running, water may run into the exhaust pipe due to wave action, causing engine trouble.

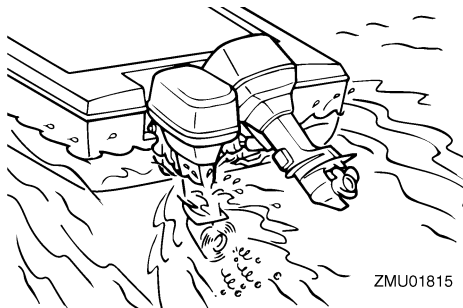

TIP:

When you are maneuvering at low speed, such as near a dock, it is recommended that both engines be running with one in neutral gear if possible.

Trouble Recovery

EMU46604

Replacing fuse

EWM00632



WARNING

Substituting an incorrect fuse or a piece of wire could allow excessive current flow. This could cause electric system damage and a fire hazard.

If a fuse has blown, replace the fuse according to the following procedure.

- (1) Turn the main switch to the "OFF" (off) position.
- (2) Remove the fuse box cover.
- (3) Remove the fuse using the fuse puller, and then install a spare fuse of the proper amperage.

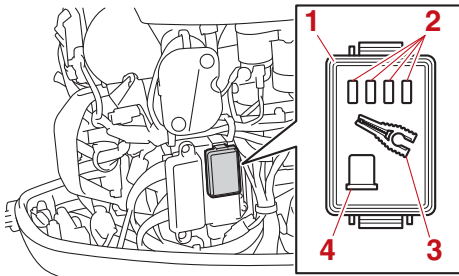

1. Fuse box cover
2. Spare fuse (10 A, 15 A, 20 A, 30 A)
3. Fuse puller
4. Spare engine main fuse (60 A)

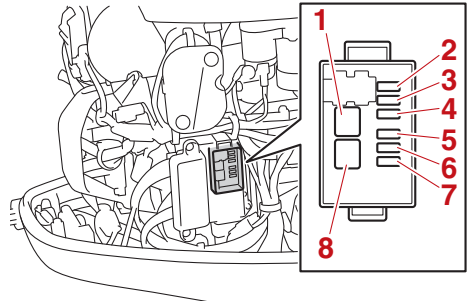

1. Engine main fuse (60 A)
2. Main switch / PTT switch fuse (20 A)
3. Electric throttle valve fuse (10 A)
4. Fuel feed pump fuse (10 A)
5. Fuel pump fuse (15 A)
6. Starter relay fuse (30 A)
7. Ignition coil / Fuel injector / Variable camshaft timing / ECM (Electronic Control Module) fuse (30 A)
8. Isolator fuse (60 A)

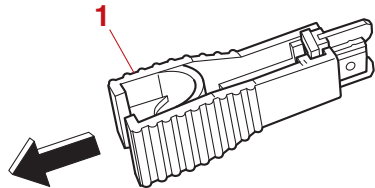

1. Fuse puller

Consult your Yamaha dealer if the new fuse immediately blows again.

ZMU08320

EMU29529

Power trim and tilt will not operate

EWM02331



WARNING

Never get under the engine while it is tilted. Severe injury could occur if the outboard motor accidentally falls.

Trouble Recovery

If the outboard motor cannot be tilted up/down using the power trim and tilt unit, e.g. because of a discharged battery or a failure with the unit itself, the outboard motor can be tilted manually.

- (1) Stop the engine.
- (2) Loosen the manual valve screw by turning it counterclockwise until it stops.

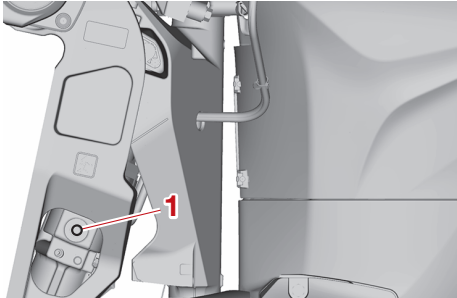

1. Manual valve screw

- (3) Adjust the outboard motor to a navigable angle, tighten the manual valve screw clockwise, and secure the outboard motor.

EMU49421

Hydraulic Steering system will not operate

If the Hydraulic Steering system does not operate, the outboard motor can be steered manually.

To steer the outboard motor manually

- (1) Remove the clamp bracket cover by removing the bolts.

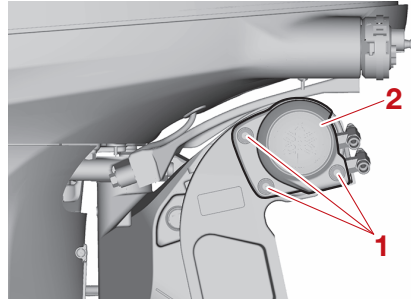

1. Bolt
2. Clamp bracket cover

- (2) Loosen the manual valve screw until it stops.

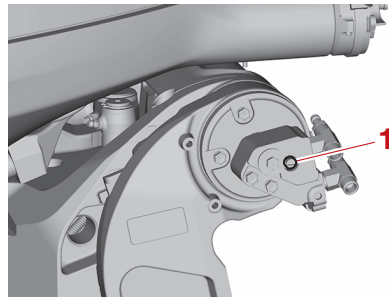

1. Manual valve screw

- (3) Steer the outboard motor manually.
- (4) Tighten the manual valve screw until it stops.

EMU44372

Water separator-alert is activated after leaving port

EWMO1501

WARNING

Gasoline is highly flammable, and its vapors are flammable and explosive.

- Do not perform this procedure on a hot or running engine. Allow the engine to cool.
- There will be fuel in the fuel filter. Keep away from sparks, cigarettes, flames or other sources of ignition.

Trouble Recovery

- This procedure will allow some fuel to spill. Catch fuel in a rag. Wipe up any spilled fuel immediately.
- The fuel filter must be reassembled carefully with the O-ring, filter cup, and hoses in place. Improper assembly or replacement could result in a fuel leak, which could result in a fire or explosion hazard.

If the water separator-alert indicator blinks or the buzzer sounds intermittently, perform the following procedure.

TIP:

The buzzer sounds only when the remote control lever is placed in neutral.

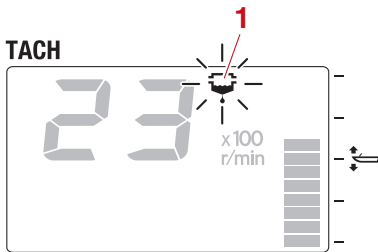

ZMU05441

1. Water separator-alert indicator

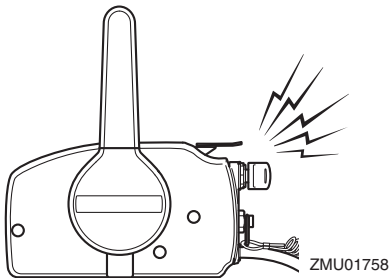

ZMU01758

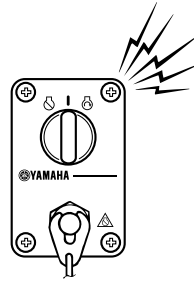

ZMU07012

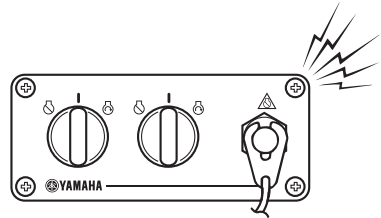

ZMU07859

- (1) Stop the engine.
- (2) Remove the top cowling.
- (3) Disconnect the water detection switch coupler. **NOTICE: Be careful not to get any water on the water detection switch coupler, otherwise a malfunction could occur.** [ECM01951]

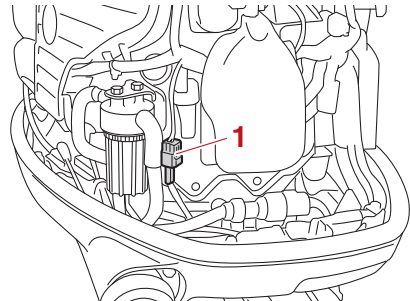

1. Water detection switch coupler
- (4) Remove the filter cup from the filter housing, and then remove the O-ring from the filter cup. **NOTICE: Be careful**

not to twist the water detection switch lead when unscrewing the filter cup.

[ECM01961]

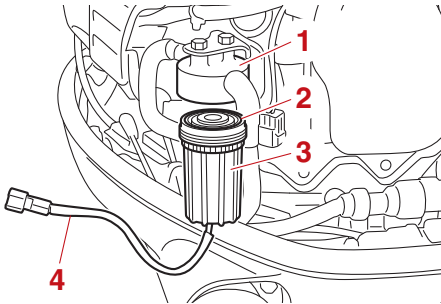

1. Filter housing
2. O-ring
3. Filter cup
4. Water detection switch lead

- (5) Drain the water in the filter cup by soaking it up with a rag.
- (6) Put the O-ring on the filter cup in its original position, and then install the filter cup onto the filter housing. **NOTICE: Be careful not to twist the water detection switch lead when screwing the filter cup onto the filter housing.** [ECM01971]

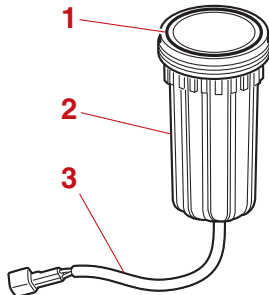

1. O-ring
2. Filter cup
3. Water detection switch lead

- (7) Connect the water detection switch coupler securely until a click is heard.
- (8) Install the top cowling.

- (9) Turn the main switch to the "ON" (on) position and check that the water separator-alert indicator remains off and the buzzer does not sound. If the water separator-alert indicator blinks or the buzzer sounds, have your Yamaha dealer check the outboard motor. **NOTICE: Although the buzzer will stop when the engine is started and the remote control lever is moved to the forward or reverse position, do not use the outboard motor. Otherwise, serious engine damage could occur.** [ECM02391]

EMU33502

Treatment of submerged motor

If the outboard motor is submerged, immediately take it to a Yamaha dealer. Otherwise some corrosion may begin almost immediately. **NOTICE: Do not attempt to run the outboard motor until it has been completely inspected.** [ECM00402]

Consumer information (For North America)

EMU29837

YAMAHA FOUR-STROKE OUTBOARD MOTOR THREE-YEAR LIMITED WARRANTY

Yamaha Motor Corporation, U.S.A. and Yamaha Motor Canada Ltd. ("Yamaha") hereby warrant that new Yamaha four-stroke outboard motors will be free from defects in material and workmanship for the period of time stated herein, subject to certain stated limitations.

PERIOD OF WARRANTY. Any new Yamaha four-stroke outboard motor purchased from an authorized Yamaha dealer in the customer's country of residence (United States or Canada) and registered with Yamaha will be warranted against defects in material or workmanship, subject to exclusions noted herein, for the following applicable period determined by type of use:

- Pleasure use – three (3) years from the date of purchase.
- Commercial application – one (1) year from the date of purchase. A commercial application is defined as any use of the outboard motor to generate income (excluding tournament fishing) or support business operations in any way during the warranty period, without regard to the type or percentage of commercial use. Yamaha reserves the right to modify incorrect registration data and reduce the warranty period to reflect commercial use.
- Yamaha peripheral equipment included with the motor, such as gauges, fuel tanks, and hoses, remote control boxes, and wiring external from the motor unit, will be warranted for one (1) year from the date of purchase for either pleasure or commercial use.

Replacement parts used in warranty repairs will be warranted for the balance of the applicable warranty period.

The second and third year of warranty (if applicable) shall be limited to covering the cost of parts and labor for major components only. The major components covered are:

Power Unit Section

- Power Head
- Intake Manifold
- Carburetor Assembly and its Related Components
- Fuel Injection System and its Related Components
- Fuel and Oil Pump Assemblies
- Ignition System (Standard and Microcomputer)

Lower Unit Section Bracket Section

- Exhaust System
- Bracket System
- Upper Casing
- Power Trim and Tilt Assembly
- Lower Unit Assembly

WARRANTY REGISTRATION. To be eligible for warranty coverage, the outboard motor must be registered with Yamaha in the country of residence. Warranty registration can be accomplished by any authorized Yamaha Outboard Motor Dealer.

OBTAINING REPAIRS UNDER WARRANTY. During the period of warranty, any authorized Yamaha Outboard Motor Dealer in the country of residence will, free of charge, repair or replace, at Yamaha's option, any parts adjudged defective by Yamaha due to faulty workmanship or material from the factory. All replaced parts will become the property of Yamaha. If the customer is temporarily using a U.S.-registered outboard motor in Canada, or a Canada-registered outboard motor in the United States, and it needs warranty repairs, the owner should contact a nearby authorized Yamaha Outboard Motor Dealer for assistance. The local dealer will contact Yamaha on the owner's behalf so that needed repairs can be made as quickly as possible.

CUSTOMER'S RESPONSIBILITY. Under the terms of this warranty, the customer will be responsible for ensuring that the outboard motor is properly operated, maintained, and stored as specified in the applicable Owner's Manual. The owner of the outboard motor shall give notice to an authorized Yamaha Outboard Motor Dealer of any and all apparent defects within ten (10) days of discovery and make the motor available at that time for inspection and repairs at the dealer's place of business.

ZMU07048

Consumer information (For North America)

GENERAL EXCLUSIONS FROM WARRANTY. This warranty will not cover the repair of damage if the damage is a result of abuse or neglect of the product. Examples of abuse and neglect include, but are not limited to:

1. Racing or competition use, modification of original parts, abnormal strain.
2. Lack of proper maintenance and off season storage as described in the Owner's Manual; installation of parts or accessories that are not equivalent in design and quality to genuine Yamaha parts.
3. Operation of the motor at an rpm other than specified, use of lubricants or oils that are not suitable for outboard motor use.
4. Damage as a result of accidents, collisions, contact with foreign materials, or submersion.
5. Growth of marine organism on motor surfaces.
6. Normal deterioration.

SPECIFIC PARTS EXCLUDED FROM WARRANTY. Parts replaced due to normal wear or routine maintenance such as oil, spark plugs, shear pins, propellers, hubs, fuel and oil filters, brushes for the starter motor and power tilt motor, water pump impellers, and anodes, are not covered by warranty. Charges for removal of the motor from a boat and transporting the motor to and from an authorized Yamaha Outboard Motor Dealer are excluded from warranty coverage.

Specific parts excluded from the second and third year of warranty (if applicable) are:

- Top and Bottom Cowling
- Electric Components (other than ignition system)
- Rubber Components (such as hoses, tubes, rubber seals, fittings, and clamps)

EMISSION CONTROL WARRANTY (United States only). Yamaha warrants to the ultimate purchaser and any subsequent owner, that the emission control components on this engine are designed, built and equipped so as to conform at the time of sale with applicable regulations under section 213 of the Clean Air Act and that this engine is covered against defects in materials and workmanship which cause said engine to fail to conform with applicable exhaust emission regulations for five (5) years from the date of purchase or 175 hours of operation, whichever comes first. Evaporative components (e.g., hoses, fuel tank, fuel cap) are two (2) years from the date of purchase. Some states have different emission control warranty provisions. As these vary from state to state, consult your Yamaha dealer or contact Yamaha Customer Relations at 1-866-894-1626 for more information.

TRANSFER OF WARRANTY Transfer of the warranty from the original purchaser to any subsequent purchaser is possible by having the motor inspected by an authorized Yamaha Outboard Motor Dealer and requesting the dealer to submit a change of registration to Yamaha within ten (10) days of the transfer.

YAMAHA MAKES NO OTHER WARRANTY OF ANY KIND, EXPRESSED OR IMPLIED. ALL IMPLIED WARRANTIES OF MERCHANTABILITY AND FITNESS FOR A PARTICULAR PURPOSE WHICH EXCEED THE OBLIGATIONS AND TIME LIMITS STATED IN THIS WARRANTY ARE HEREBY DISCLAIMED BY YAMAHA AND EXCLUDED FROM THIS WARRANTY. SOME STATES/PROVINCES DO NOT ALLOW LIMITATIONS ON HOW LONG AN IMPLIED WARRANTY LASTS, SO THE ABOVE LIMITATIONS MAY NOT APPLY TO YOU. ALSO EXCLUDED FROM THIS WARRANTY ARE ANY INCIDENTAL OR CONSEQUENTIAL DAMAGES INCLUDING LOSS OF USE. SOME STATES/PROVINCES DO NOT ALLOW THE EXCLUSION OR LIMITATION OF INCIDENTAL OR CONSEQUENTIAL DAMAGES, SO THE ABOVE EXCLUSION MAY NOT APPLY TO YOU.

THIS WARRANTY GIVES YOU SPECIFIC LEGAL RIGHTS, AND YOU MAY ALSO HAVE OTHER RIGHTS WHICH VARY FROM STATE TO STATE/PROVINCE TO PROVINCE.

ZMU07047

Consumer information (For North America)

EMU29846

IMPORTANT WARRANTY INFORMATION IF YOU USE YOUR YAMAHA OUTSIDE THE U.S.A. OR CANADA

Welcome to the Yamaha Family!

Congratulations on the purchase of your new Yamaha products. Yamaha is committed to exceptional customer satisfaction and we want your ownership experience to be a satisfying one. Please read the following warranty information to help ensure satisfaction with your Yamaha.

This model was manufactured with specifications appropriate for sale and use in the U.S.A. and Canada. Please note the following information:

1. As explained in the Limited Warranty Statement, the Yamaha warranty covers your Yamaha when it is registered and used in your country of residence. If you are temporarily using a U.S.-registered outboard motor in Canada, or a Canada-registered outboard motor in the United States, and it needs warranty repairs, you should contact a nearby authorized Yamaha Outboard Motor Dealer for assistance. The local dealer will contact Yamaha on the owner's behalf so that needed repairs can be made as quickly as possible.
2. If you need repairs while temporarily using your Yamaha in another country, contact the local authorized Yamaha distributor for that country. Yamaha will work with that distributor to make the needed repairs as quickly as possible. If you have to pay for a repair that you believe your warranty would have covered at home, present all repair orders, receipts, or other related documents to your local dealer when you return home. He will be able to contact Yamaha on your behalf to see if any refund can be provided.

TIP:

Your Yamaha model may not be sold in some countries. Therefore, a Yamaha dealer outside the United States or Canada may not have all of the replacement parts or technical information available to provide proper service. This may unavoidably delay repairs. Thank you for your understanding should this happen.

3. If your Yamaha is registered or used primarily outside the United States or Canada, the warranty printed in this manual does not apply to you. Contact the dealer who sold the Yamaha marine power unit to you for customer support information.

ZMU05199

6Y8 Multifunction meters.....	45	Cowling lock lever.....	35
A		Cruising in salt water or other conditions.....	72
Accident reporting.....	4	D	
Alcohol and drugs.....	2	Digital speedometer.....	38
Alert system.....	49	Digital tachometer.....	37
Anode(s), inspecting and replacing.....	94	E	
Anti-fouling paint.....	21	EC Declaration of Conformity (DoC).....	10
Approval label of emission control certificate.....	22	Electric shock.....	1
Avoid collisions.....	3	Emergency equipment.....	22
B		Emergency, running single engine in an.....	101
Basic boating rules (Rules of the road)...	6	Emergency, temporary action in.....	101
Battery.....	60	Emission control information.....	22
Battery, checking (electric start models).....	95	Engine data recording.....	14
Battery, connecting.....	95	Engine oil.....	57
Battery, disconnecting.....	97	Engine oil, changing.....	85
Battery requirements.....	17	Engine oil, filling.....	55
Boat education and training.....	4	Engine oil requirements.....	19
Boat horsepower rating.....	16	Engine shut-off cord (lanyard).....	1, 57
Boating organizations.....	5	Engine shut-off cord (lanyard) and clip.....	31
Boating safety.....	2	F	
Boating safety publications.....	5	Filling fuel.....	60
Breaking in engine.....	55	First-time operation.....	55
C		Flushing cooling water passage.....	75
Carbon monoxide.....	2	Flushing device.....	35, 58
CE Marking / UKCA Marking.....	10	Flushing with the flushing attachment.....	74
Checks after engine warm up.....	64	Free accelerator.....	30
Checks after starting engine.....	63	Fuel consumption meter.....	41
Checks before starting engine.....	56	Fuel economy.....	41
CL5 Display.....	43	Fuel filter.....	36
Cleaning and anticorrosion measures.....	75	Fuel filter, checking.....	57
Cleaning the outboard motor.....	76	Fuel flow meter.....	41
Clock.....	39	Fuel gauge.....	39
Collisions with floating or submerged objects.....	3	Fuel leaks, checking for.....	56
Compliance mark label.....	11	Fuel level.....	56
Components diagram.....	25	Fuel level-alert indicator.....	40
Control functions, checking.....	57	Fuel management meter.....	40
Cooling water.....	63	Fuel requirements.....	19

INDEX

- Fuel system 56
Fuse, replacing 102
- G**
Gasoline..... 2, 19
Gasoline Additives..... 21
Gasoline exposure and spills..... 2
Gear oil, changing..... 93
Greasing 82
- H**
Hot parts..... 1
Hour meter..... 37
Hydraulic steering fluid requirements... 19
Hydraulic Steering system will not operate 103
- I**
Identification numbers record..... 10
Idle speed, inspecting 85
Impact damage..... 101
Installation requirements 16
- K**
Key number 10
- L**
Laws and regulations..... 5
Low battery voltage-alert indicator..... 40
Low oil pressure alert 50
Low oil pressure-alert indicator..... 38
Lubrication..... 75
- M**
Main switch 32
Maintenance chart 1 78
Maintenance chart 2..... 81
Maintenance interval guidelines 77
Modifications 2
Mounting height..... 53
Mounting outboard motor 16
Mounting the outboard motor 53
Muddy or acidic water 21
- N**
Neutral interlock trigger 29
Neutral throttle lever 29
- O**
Operating engine 61
Outboard motor, checking 58
Outboard motor disposal requirements 22
Outboard motor (painted surface), checking 76
Outboard motor safety 1
Outboard motor serial number 10
Overheat alert 49
Overheat-alert indicator 38
Overloading 3
- P**
Passenger training 5
Passengers 2
People in the water 2
Periodic maintenance 77
Personal flotation devices (PFDs)..... 2
Power trim and tilt 1
Power trim and tilt switch (bottom cowling) 33
Power trim and tilt switch (remote control) 32
Power trim and tilt switches (twin binnacle type) 33
Power trim and tilt system 59
Power trim and tilt will not operate..... 102
Propeller 1
Propeller (counter rotation models) 18
Propeller, inspecting 91
Propeller, installing 92
Propeller, removing..... 92
Propeller selection 18
- R**
Read manuals and labels 12
Remote control box 28
Remote control lever 29
Remote control requirements 16

Replacement parts	77	W	
Replacing the engine oil filter	90	Warming up engine.....	64
Rotating parts	1	Warning labels	12
Rules when encountering vessels	6	Warranty information (use outside the U.S.A. or Canada).....	108
S		Warranty, limited.....	106
Sending fuel.....	61	Water separator alert	51
Shallow water	71	Water separator-alert indicator.....	43
Shifting.....	64	Water separator-alert is activated after leaving port	103
Shifting (checks after engine warm up)	64	Weather	4
Spark plug, inspecting.....	84	Wiring and connectors, inspecting	91
Specifications	15	Y	
Speedometer	38	Yamaha Security System (Y-COP/Optional).....	27
Star labels.....	23	Yamalube.....	90
Starting engine	61		
Start-in-gear protection.....	18		
Steering and sailing rules and sound signals	6		
Stop switches	64		
Stopping boat.....	65		
Stopping engine	66		
Storing outboard motor	73		
Submerged outboard motor.....	105		
T			
Tachometer	37		
Throttle friction adjuster.....	30		
Tilt support lever	34		
Tilting up and down	68		
Top cowling, installing	58		
Top cowling, removing	56		
Transporting and storing outboard motor	73		
Trim meter	37		
Trim tab with anode.....	34		
Trimming outboard motor.....	66		
Trip meter	39		
Troubleshooting.....	98		
Twin-engine speed synchronizer.....	42		
V			
Voltmeter	40		

For your best ownership experience, think **Genuine Yamaha!**

Genuine Yamaha Parts — Genuine Yamaha replacement parts are the exact same parts as the ones originally equipped on your vehicle, providing you with the performance and durability you have come to expect. Why settle for aftermarket parts that may not provide full confidence and satisfaction?

Genuine Yamaha Accessories — Yamaha only offers accessories that meet our high standards for quality and performance. Buy with confidence, knowing your Genuine Yamaha Accessories will fit right and perform right — right out of the box.

Yamalube — Take care of your Yamaha with legendary Yamalube oils, lubricants, and care products. They're formulated and approved by the toughest judges we know: the Yamaha engineering teams that know your Yamaha from the inside out.

Genuine Yamaha Service Manuals — Get the same factory manual for your vehicle that the technicians at your authorized Yamaha dealer use. Service manuals are available through your Yamaha dealer or you can order them directly through yamahapubs.com (USA only).

Genuine Yamaha products are available only from your Yamaha dealer.

Find out more at www.yamaha-motor in your country of residence.



Printed in Japan
November 2022-0.7 × 1 CR