

OWNER'S MANUAL

TOHATSU
Outboards

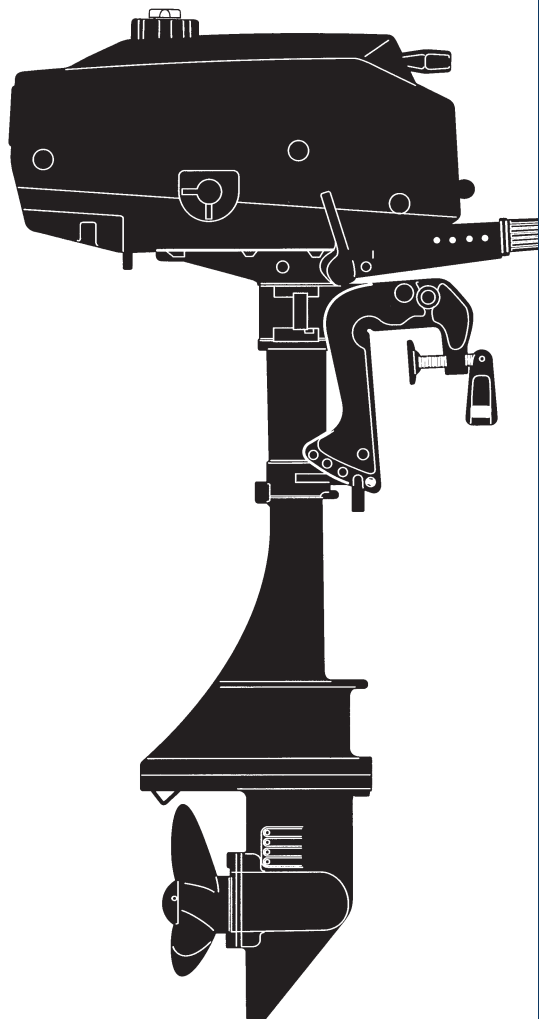

M 2.5A2
3.5A2
3.5B

OB No.003-11045-6

⚠ READ THIS MANUAL BEFORE USING THE OUTBOARD MOTOR. FAILURE TO FOLLOW THE INSTRUCTIONS AND SAFETY PRECAUTIONS IN THIS MANUAL CAN RESULT IN SERIOUS INJURY OR DEATH. KEEP THIS MANUAL IN A SAFE LOCATION FOR FUTURE REFERENCE.

Copyright © 2011 Tohatsu Corporation. All rights reserved. No part of this manual may be reproduced or transmitted in any form or by any means without the express written permission of Tohatsu Corporation.

YOUR TOHATSU OUTBOARD MOTOR

OWNER REGISTRATION AND IDENTIFICATION

Upon purchasing this product, be sure that the WARRANTY CARD is correctly and completely filled out and mailed to the addressee noted there on. This WARRANTY CARD identifies you as the legal owner of the product and serves as your warranty registration.

TO THE EXTENT PERMITTED BY APPLICABLE LAW, YOUR OUTBOARD MOTOR WILL NOT BE COVERED BY THE APPLICABLE LIMITED WARRANTY, IF THIS PROCEDURE IS NOT FOLLOWED.

PRE-DELIVERY CHECK

Be sure that the product has been checked by an authorized TOHATSU dealer before you take delivery.

Limited Warranty

Please refer to the TOHATSU outboard motor Limited warranty provided to you with this product, the terms and conditions of which, as amended from time to time, are incorporated by reference into the manual.

Serial Number

In the space below, please record the outboard motor's serial number (indicated both on the swivel bracket and on the cylinder block). The serial number will be needed in the event of theft or to quickly identifying the outboard motor type.

Serial Number :

To You, Our Customer

Thank you for selecting a TOHATSU outboard motor. You are now the proud owner of an excellent outboard motor that will service you for many years to come.

This manual should be read in its entirety and the inspection and maintenance procedures described later in this manual should be followed carefully. Should a problem arise with the outboard motor, please follow the troubleshooting procedures listed at the end of this manual. If the problem persists, contact an authorized TOHATSU service shop or dealer.

We hope you will enjoy your outboard motor and wish you good luck in your boating adventures.

TOHATSU CORPORATION

CONTENTS

GENERAL SAFETY INFORMATION	8
1 SPECIFICATIONS	10
2 NAMES OF PARTS	11
3 INSTALLATION	12
1. Mounting the outboard motor on boat	12
4 PRE-OPERATING PREPARATIONS	14
1. Recommended gasoline types	14
2. Recommended engine oil	16
3. Break-in	18
5 ENGINE OPERATION	19
1. Starting	19
2. Warming up the engine	22
3. Forward and reverse	23
4. Stopping	26
5. Trim angle	27
6. Tilt up and tilt down	28
7. Outboard motor position in tilt up	29
8. Mooring the boat	29
6 REMOVING AND CARRYING THE OUTBOARD MOTOR	30
1. Removing the outboard motor	30
2. Carrying the outboard motor	30
3. Storing the outboard motor	31
7 TRAILERING	32
8 ADJUSTMENT	33
1. Steering friction	33
9 INSPECTION AND MAINTENANCE	34
1. Daily inspection	35
2. Periodic inspection	41
3. Off-season storage	43
4. Pre-season check	43
5. Motor submerged in water	44
6. Cold weather precautions	44
7. Checking after striking underwater object	44
10 TROUBLESHOOTING	45
11 TOOL KIT AND SPARE PARTS	47
12 OPTIONAL ACCESSORIES	48
13 PROPELLER TABLE	49

INDEX

GENERAL SAFETY INFORMATION

1. SPECIFICATIONS

1

2. NAMES OF PARTS

2

3. INSTALLATION

3

4. PRE-OPERATING PREPARATIONS

4

5. ENGINE OPERATION

5

6. REMOVING AND CARRYING THE OUTBOARD MOTOR

6

7. TRAILERING

7

8. ADJUSTMENT

8

9. INSPECTION AND MAINTENANCE

9

10. TROUBLESHOOTING

10

11. TOOL KIT AND SPARE PARTS

11

12. OPTIONAL ACCESSORIES

12

13. PROPELLER TABLE

13

GENERAL SAFETY INFORMATION

NOTICE : DANGER/WARNING/CAUTION/Note

Before installing, operating or otherwise handling your outboard motor, be sure to thoroughly read and understand this Owner's Manual and carefully follow all of the instructions. Of particular importance is information preceded by the words "DANGER," "WARNING," "CAUTION," and "Note." Always pay special attention to such information to ensure safe operation of the outboard motor at all times.

DANGER

Failure to observe will result in severe personal injury or death, and possibly property damage.

WARNING

Failure to observe could result in severe personal injury or death, or property damage.

CAUTION

Failure to observe could result in personal injury or property damage.

Note

This instruction provides special information to facilitate the use or maintenance of the outboard motor or to clarify important points.

EMERGENCY STOP SWITCH

The Emergency Stop Switch will stall the outboard motor when the stop switch tether is pulled off. This stop switch tether can be attached to the operator of the outboard motor to minimize or prevent injuries from the propeller in case the operator falls overboard.

We highly recommend use of the Emergency Stop Switch tether.

WARNING

Accidental activation of the Emergency Stop Switch (such as the tether being pulled out in heavy seas) could cause passengers to lose their balance and even fall overboard, or it could result in loss of power in heavy seas, strong currents, or high winds. Loss of control while mooring is another potential hazard.

To minimize accidental activation of the Emergency Stop Switch, the 500 mm (20 inch.) stop switch tether is coiled and can extended to a full 1,300 mm (51 inch.).

SAFE OPERATION OF BOAT

As the operator/driver of the boat, you are responsible for the safety of those aboard and those in other boat around yours, and for following local boating regulations. You should be thoroughly knowledgeable on how to correctly operate the boat, outboard motor, and accessories. To learn about the correct operation and maintenance of the outboard motor, please read through this manual carefully. It is very difficult for a person standing or floating in the water to take evasive action should he or she see a power boat heading in his /her direction, even at a slow speed. Therefore, when your boat is in the immediate vicinity of people in the water, the outboard motor should be shifted to neutral and shut off.

WARNING

SERIOUS INJURY IS LIKELY IF A PERSON IN THE WATER MAKES CONTACT WITH A MOVING BOAT, GEAR HOUSING, PROPELLER, OR ANY SOLID DEVICE RIGIDLY ATTACHED TO A BOAT OR GEAR HOUSING.

SERVICING, REPLACEMENT PARTS & LUBRICANTS

We recommend that only an authorized service shop perform service or maintenance on this outboard motor. Be sure to use genuine parts, genuine lubricants, or recommended lubricants.

MAINTENANCE

As the owner of this outboard motor, you should be acquainted with correct maintenance procedures. It is the operator's responsibility to perform all safety checks and to ensure that all lubrication and maintenance instructions are complied with for safe operation. Please comply with all instructions concerning lubrication and maintenance. You should take the engine to an authorized dealer or service shop for periodic inspection at the prescribed intervals.

Correct periodic maintenance and proper care of this outboard motor will reduce the chance of problems and limit overall operating expenses.

MOUNTING

Outboard motor mounting must be performed by trained service person(s) using lift or hoist with sufficient capacity.

SPECIFICATIONS

2.5A2, 3.5A2, 3.5B2

Item	MODEL	2.5A2	3.5A2	3.5B2
	Overall Length	mm (in)	550 (21.7)	
Overall Width	mm (in)	195 (7.7)		220 (8.7)
Overall Height S-L	mm (in)	955 (37.6) · 1,082 (42.6)		
Transom Height S-L	mm (in)	435 (17.1) · 562 (22.1)		
Weight	S kg (lb)	12.5 (28)		13.0 (29)
	L kg (lb)	13.0 (29)		13.5 (30)
Output	kW (Hp)	1.8 (2.5)	2.6 (3.5)	
Max. Operating Range	rpm	3,800-5,200	4,200-5,300	
Idle Speed in Forward Gear	rpm	1,100		
Idle Speed in Neutral Gear	rpm	-		1,300
Engine Type		2 stroke		
Number of Cylinder		1		
Piston Displacement	mL (Cu in)	74.6 (4.55)		
Bore x Stroke	mm (in)	47 x 43 (1.85 x 1.69)		
Exhaust System		Underwater exhaust		
Lubrication Engine		Fuel Mixture		
Fuel Mixing Ratio		50 : 1		
Cooling System		Forced water cooling		
Starting System		Recoil starter & pull rope		
Ignition System		Flywheel Magneto C.D. Ignition		
Spark Plug		NGK BP6HS-10/BPR6HS-10		
Trim Position		4		
Engine Oil		Genuine motor oil or recommended one (TCW-III)		
Gear Oil		Genuine Gear Oil or API GL5, SAE #80 to #90, approx 3.5B2:180mL, 3.5A2 & 2.5A2:90mL		
Fuel Tank Capacity	L (US gal)	Approx. 1.4 (0.37) integral tank		
Fuel Consumption (at full throttle) L/H (US gal/Hr)		1.4 (0.37)	1.7 (0.45)	
Gear Reduction Ratio		1.85 (13 : 24)		2.15 (13 : 28)
Clutch		Forward		F-N
Propeller (Blade x Diameter x Pitch)		F-6 (3 x 188 x 145)		I-7 (3 x 188 x 178)
Fuel		Unleaded regular gasoline pump posted 87 Octane (research octane rating of 91)		

Remark : Specifications subject to change without notice.

■ NAMES OF PARTS

2.5A2, 3.5A2, 3.5B2

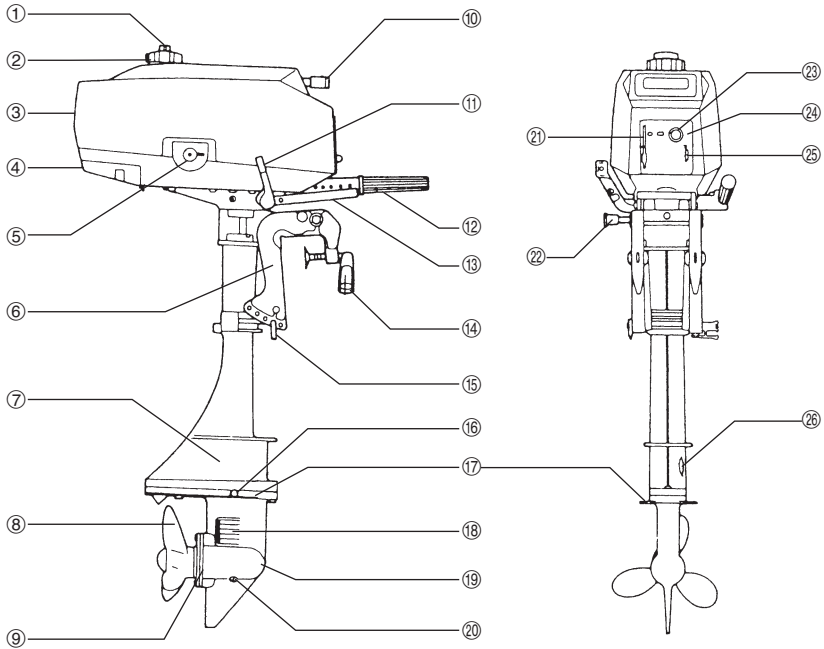

- | | |
|----------------------------|--|
| ① Air Vent Screw | ⑭ Clamp Screw |
| ② Fuel Tank Cap | ⑮ Thrust Rod |
| ③ Top Cowl | ⑯ Oil Plug (Upper) |
| ④ Plug Cap Cover | ⑰ Anti Ventilation Plate |
| ⑤ Fuel Cock | ⑱ Water Inlet (3.5B2 only) |
| ⑥ Clamp Bracket | ⑲ Gear Case |
| ⑦ Drive Shaft Housing | ⑳ Oil Plug (Lower) |
| ⑧ Propeller | ㉑ Throttle Lever |
| ⑨ Water Inlet (3.5B2 only) | ㉒ Tilt Stopper |
| ⑩ Starter Handle | ㉓ Stop Switch |
| ⑪ Shift Lever | ㉔ Carburetor Cover |
| ⑫ Handle Grip | ㉕ Choke Lever |
| ⑬ Carrying Handle | ㉖ Drive Shaft Housing Grommet (3.5B2 only) |

INSTALLATION

1. Mounting the outboard motor on boat

WARNING

Most boats are rated and certified in terms of their maximum allowable horsepower, as shown on the boat's certification plate. Do not equip your boat with an outboard motor that exceeds this limit. If in doubt, contact your dealer.

Do not operate the outboard motor until it has been securely mounted on the boat in accordance with the instructions below.

Installation...Above keel line

Set engine at center of boat.

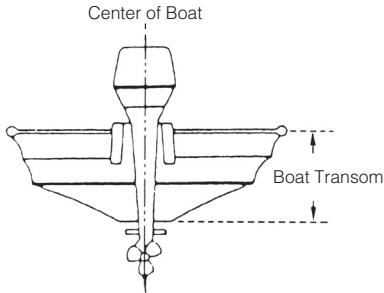

Transom matching

- ① Be sure that the anti ventilation plate of the outboard motor is 30-50mm (1.2-2 in) below the water surface.

If the above condition cannot be met due to the shape of the bottom of your boat, please consult your authorized dealer.

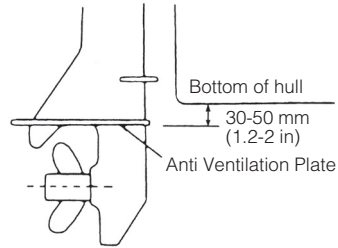

- ② To attach the outboard motor to the boat, tighten the clamp screws by turning their handles. Also, retighten the screws from time to time to ensure safety. Secure the outboard motor with a rope to prevent loss overboard.

Note

A rope is not included in the standard accessories.

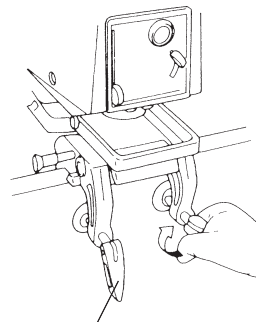

Clamp screw

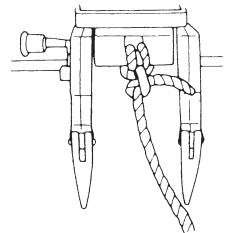

⚠ CAUTION

- Before beginning the running test, check that the boat with maximum capacity loading floats on the water in a proper attitude. Check the position of water surface on the driveshaft housing. If the water surface is near the bottom cowling, in high waves, water may enter the engine cylinders.
- Incorrect outboard motor mounting height or existence of underwater object(s), such as hull bottom design, bottom surface conditions or underwater accessories, can cause water spray possibly reaching the engine through an opening of the bottom cowling during cruising. Exposing the engine to such conditions for extended periods can lead to severe engine damage.

⚠ WARNING

If the length of security line being used is long enough to allow the outboard to disengage off the boat transom but is too short to not allow the outboard to submerge behind the boat and stop running, the outboard could continue running and propeller it self back into the boat with the propeller rotating under power. This exposes the occupants to serious injury or death.

⚠ WARNING

- Mounting the outboard motor without following this manual can lead to unsafe conditions such as poor maneuverability, lack of control or fire.
- Loose clamp screws and/or mounting bolts can lead to the release or displacement of the outboard motor, possibly resulting in lost of control and/or serious personal injury. Be sure that fasteners are tightened to the specified torque (30 Nm (3.0kgf) 13ft-lb). Check the fasteners for tightness from time to time.
- Be sure to use outboard mounting fasteners included in the outboard motor package or their equivalents in terms of size, material, quality and strength.
Tighten fasteners to the specified torque (30 Nm (3.0kgf) 13ft-lb). Test cruise to check if fasteners are tightened securely.
- Outboard motor mounting must be performed by trained service person(s) using lift or hoist with sufficient capacity.

PRE-OPERATING PREPARATIONS

DANGER

Consult an authorized dealer for details on handling of gasoline, if necessary.

Gasoline and its vapors are very flammable and can be explosive.

When carrying a fuel tank containing gasoline:

- Close the air vent screw of fuel tank cap, or gasoline vapor will be emitted through the air vent screw, creating a fire hazard.
- Do not smoke.

When or before refueling :

- Stop the engine, and do not start the engine during refueling.
- Do not smoke.
- Be careful not to overfill fuel tank. Wipe up any spilled gasoline immediately.

When or before cleaning the gasoline tank :

- Dismount fuel tank from the boat.
- Place the fuel tank away from every source of ignition, such as sparks or open flames.
- Do the work outdoors or in well ventilated area.
- Wipe up any spilled gasoline immediately.

After cleaning gasoline tank :

- Wipe up any spilled gasoline immediately.
- If the fuel tank is disassembled for cleaning, reassemble carefully. Imperfect assembly may cause a fuel leak, possibly leading to fire or explosion.
- Dispose of aged or contaminated gasoline in accordance with local regulations.

1. Recommended gasoline types

CAUTION

Use of low-quality gasoline results in a short engine life as well as starting difficulties and other engine problems. We recommend use for Fuel stabilizer.

Use of unleaded gasoline

Use a major brand of automotive unleaded gasoline with a minimum posted octane rating of 91RON. Automotive gasoline that contain fuel injector cleaner are preferred for added internal engine cleanliness. Leaded gasoline is acceptable in areas where unleaded gasoline is not available.ere unleaded gasoline is not available.

Use of alcohol free gasoline

 CAUTION
<p>Use of gasoline containing alcohol can cause engine starting and/or operating difficulties, wear of and damages to engine parts, and deterioration of chemical parts, which may lead to shortening of your outboard motor's life.</p>

<p>Note</p> <p>The adverse effect caused by the alcohol content is more severe with methanol than with ethanol.</p>
--

TOHATSU recommend the use of gasoline if its ethanol content is less than 10% or methanol content is less than 5%, only in case alcohol free gasoline is not available.

The alcohol component of the gasoline absorbs moisture from the air, which may disturb regular fuel flow in the fuel system, and also accelerate rusting of engine parts.

Mixing of the moisture in the engine oil can also deteriorate the properties of the lubricant.

If the use of gasoline containing alcohol is inevitable, or presence of alcohol is suspected in the gasoline, it is strongly recommended to add a filter that has water separating capability, and check the fuel system for leaks and mechanical parts for corrosion and abnormal wear more frequently.

And, in case any of such abnormality is found, discontinue the use of such gasoline and contact our dealer immediately.

Damages resulting from the use of gasolines that contain alcohol are not covered under the limited warranty.

Fuel tank capacity : 1.4 liters (0.37 U.S. gal)

Fuel Tank : When using a fixed fuel tank in place of genuine fuel tank, it is recommended to select a one with a structure facilitating interior cleaning.

 WARNING
<p>Do not fill the fuel tank over capacity. The rise of gasoline temperature may cause gasoline to expand which, if overfilled, may leak through air vent screw when it is open. Leaking gasoline is a dangerous fire hazard.</p>

2. Recommended engine oil

Use a genuine engine oil or recommended one. Refer to your Distributor.
Will not recommend use of other two stroke engine oil.

CAUTION

Do not mix different brands of oil. Mixing different brands of oil, or different types of oil even if the brand is the same, may cause gelling, resulting in possible filter screen blockage. This could result in serious engine damage because of impaired lubrication performance.

Note

Use of engine oils that do not meet these requirements will result in reduced engine life, and other engine problems.

Add engine oil into fuel oil tank. The mixing ratio with gasoline is 1 : 50 (one part oil and 50 parts gasoline). Mix well by hand. The mixing ratio during break-in running is 1 : 25.

Mixing Ratio

	Engine Oil : Gasoline
During break-in	1 : 25
After break-in	1 : 50

4

Fuel by Oil Mixing (1:25, 1:50)

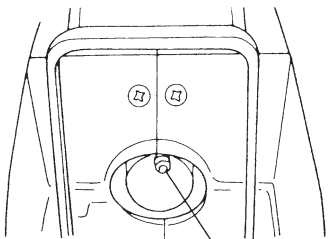
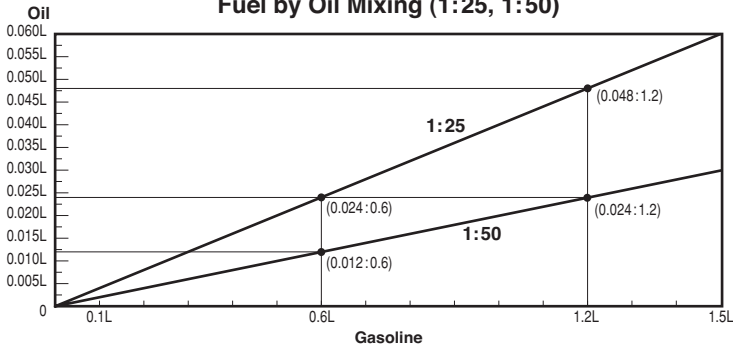

Fuel drain plug of carburetor

Notes

- Always use fresh gasoline. Fuel kept in the fuel tank for a long period will produce varnish and gum, which can damage the outboard and create problems in running.
- Use only fuel in which the gasoline and oil have been well-mixed.
- When Filling the fuel tank, be careful that no dust, water or other foreign matter enters the tank.
- Do not fill the fuel tank up to the top of the mouth ring.
- After filling the tank, close the tank cap securely.
- When carrying the fuel tank, close the air vent screw and fuel cock securely, and drain the fuel in the carburetor oil chamber completely by removing the drain plug with a screwdriver.

Engine oil – gasoline mixing procedure

For quantities of engine oil and gasoline to be pre-mixed, refer to table in previous page.

CAUTION

- Do not use other than two stroke engine oil with specified grade, or the engine may be damaged.
- Do not use fuel prepared in other than specified mixing ratio.
 - Lack of engine oil can cause severe engine trouble such as piston seizure.
 - Excess of engine oil can shorten spark plug life, and/or cause increase of noxious exhaust.

■ When portable fuel tank is used for operation of outboard motor(s):

- ① Pour engine oil into fuel tank, and then, gasoline.
- ② Put cap on the tank, and close tightly.
- ③ Close air vent plug tightly.

WARNING

Loose cap or air vent plug can cause leak of fuel during shaking the tank.

- ④ Shake the tank to mix engine oil and gasoline well and even.

■ When fuel tank built in the boat is used for operation of outboard motor(s):

- ① Prepare separate fuel container for pre-mixing.

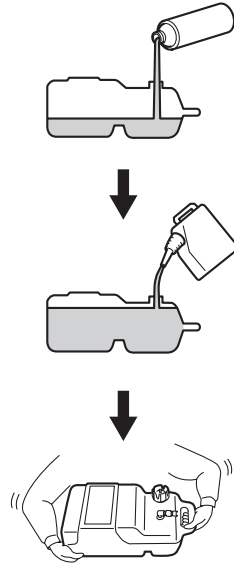

- ② Pour engine oil into fuel container, and then, gasoline.
- ③ Put cap on the container, and close tightly.
- ④ Shake the container to mix engine oil and gasoline well and even.
- ⑤ Pour the mixture into fuel tank.

Notes

- It is recommended to pre-mix by using separate fuel container. Attempting to pre-mix in the fuel tank built-in the boat can make the mixture uneven.
- If built-in fuel tank is used for mixing, pour engine oil into the tank little by little while putting gasoline into the tank.

3. Break-in

Your new outboard motor and lower unit require break-in for the moving components according to the conditions described in the following time table.

	0 – 10 min	10 min – 3 hrs	3 – 5 hrs	After 5 hrs
Throttle Position	Idle	Less than 1/2 throttle	Less than 3/4 throttle	Full throttle available
Speed	① Cruising at minimum speed	② Approx. 500 – 3,500 rpm	③ Approx. 4,000 rpm.	④ Available to operate at wide open throttle

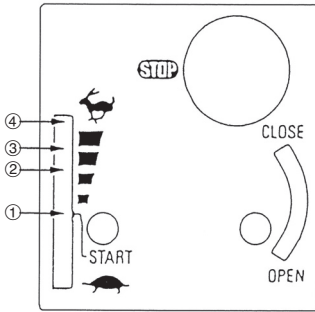

⚠ CAUTION

Operating the outboard motor without break-in can shorten service life of the product.

If any abnormality is experienced during the break-in:

- Discontinue the operation immediately.
- Have the dealer check the product and take proper action(s) if necessary.

○ Note

Proper break-in allows outboard motor to deliver it full performance for longer service life.

⚠ CAUTION

- During the break-in period, never run the engine continuously at high speed.
- After running-in is completed, select the correct propeller so that the engine speed is the recommended range at the wide-open throttle.
- After completing 5 hours of break-in, replace the gear oil with new oil. Refer to “Changing the gear oil” in subsection (2), Periodic Inspection.

Fuel mix ratio for break-in

Gasline 25: Genuine Engine Oil 1

- 25:1 when using genuine engine oil or the recommended one (TCW3).

⚠ DANGER

Do not operate the outboard motor in closed area or area with no forced ventilation.

Exhaust gas emitted by this outboard motor contains carbon monoxide that will cause death if inhaled continuously. Inhaling the gas initially causes symptoms such as feeling of sickness, drowsiness and headache.

During operation of the outboard motor:

- Keep peripheral area well ventilated.
- Always attempt to stay on the windward side of emission.

ENGINE OPERATION

1. Starting

Note

The engine will not start unless the switch lock has been properly connected **into the emergency stop switch**.

! WARNING

Do not operate the engine with gear case out of water.
Severe personal injury, or engine damage will result.

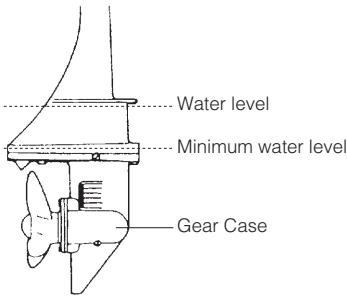

- ① Fill the fuel tank with the correct fuel mixture. The tank has a capacity of approx. 1.4 liters, permitting the engine to be operated for 30 to 40 minutes. Be careful not to spill any fuel on board. If any fuel or gasoline is spilled, wipe it up thoroughly for safety.

- ② Loosen the air vent screw on the tank cap.

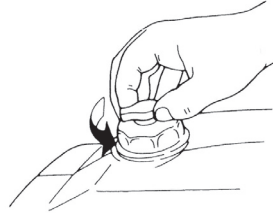

- ③ Make sure that the shift lever is in the "NEUTRAL" position. (3.5B2 only)

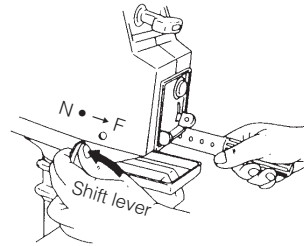

! WARNING

In case engine starts in gear, do not start cruising. Stop engine immediately and consult an authorized dealer.

- ④ Turn the fuel cock-lever to the “OPEN” position.

Note
If fuel is not supplied immediately to the carburetor (new engine or after cleaning), wait for about 15 seconds for the proper quantity of fuel to flow into the carburetor after opening the fuel cock.

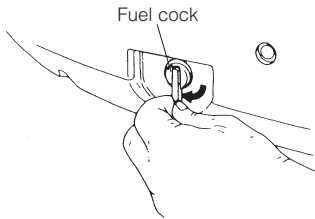

- ⑤ Set the choke lever to the “CLOSE” position.

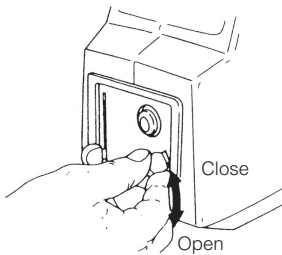

Notes

- If the engine is still warm from previous running, set the choke lever to the “OPEN” position to restart.
- When restarting the engine just after the engine has stopped, never set the choke lever to the “CLOSE” position. If the choke lever is set to the “CLOSE” position, excess fuel will be supplied to the carburetor leading to difficulty in starting the engine.

- ⑥ Set the throttle lever to the “START” position.

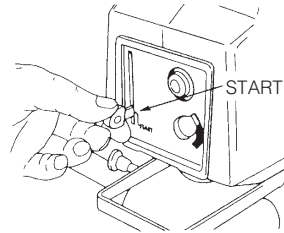

- ⑦ Ease out the recoil starter grip slowly until you feel the ratchet engage, then give it a sharp tug.

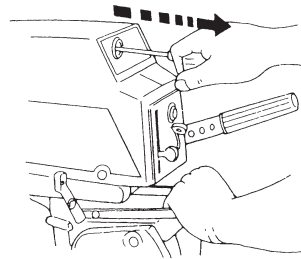

Note
Return the recoil starter grip slowly when the engine has started. Releasing the starter grip at the extended position may cause a trouble in the starting system.

Note
In cold weather, pull the starter handle 2 or 3 times while moving up the choke lever to choke the engine.

- ⑧ When the engine has started, immediately return the choke lever to the "OPEN" position then move the throttle lever downward to slow speed.

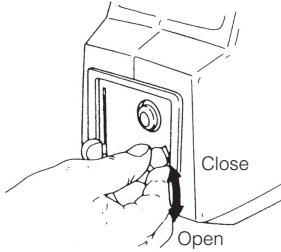

CAUTION

When the shift lever is at the "NEUTRAL" position, never move the throttle lever to medium or high speeds. This may cause serious damage to the engine by rotating it at excessively high speed. (3.5B2)

Note

If the engine stops soon after having been started with the choke lever at the "CLOSE" position, set the choke lever to the "OPEN" position and perform the starting procedure again.

If the recoil starter fails to operate

- Remove the top cowl by releasing the screws, and remove the recoil starter from the top of the fuel tank. Wrap a rope around the starter pulley about 3 times then pull quickly to start.
- Use a 10 mm socket wrench as a rope handle.

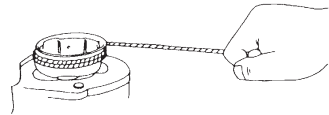
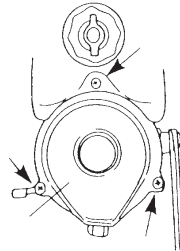
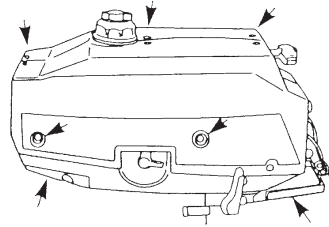

WARNING

Be careful that your clothes or other items do not get caught in the rotating engine parts.

To prevent accident and injury, do not re-attach the recoil starter after the engine has been started using the emergency starter rope. Be sure to put the top cowl back on.

Immediately contact an authorized dealer when reaching shore.

WARNING

- Be sure that no bystander(s) is within 2 meters from back of starting operator.
- Do not operate the outboard motor with top cowl removed from the power unit, or contacting turning flywheel which can lead to serious personal injury.

⚠ WARNING

- When the engine cover and recoil starter have been removed for emergency starting, take extreme care that the operator's clothes or other items do not get caught the rope or other engine pans once the engine starts running.
- Never touch the spark plug or high-tension cable when the engine is running, since they are carrying high-voltage electricity.
- Avoid high-speed running for safety. A medium or low speed is recommended, taking care not to splash water on the fuel tank or electrical parts.
- Once the engine has been started, never attach the engine cover, etc. to avoid danger.
- If the recoil starter is out of order, have it repaired immediately by your dealer. Emergency rope starting should be performed only in the case of emergency.

⚠ CAUTION

- Never remove the carburetor cover.
- Do not leave the connectors of the electrical lead wires in a disconnected condition. The engine cannot be stopped if the lead wire of the stop switch is disconnected. Never disconnect the lead wire connector or touch the lead wires while the engine is running.
- When removing the engine cover, place the screws, etc. in a bag to avoid losing them.
- Take care not to drop the plug cap cover. It is recommended to remove it first.
- When starting using an emergency starting rope, make sure that nobody else is in the vicinity of the engine.

2. Warming up the engine

Warm the engine at low engine speeds for about three minutes. This allows the lubricating oil to circulate to all parts of the engine. Operating the engine without warm up shortens the engine's life.

Be sure to check that cooling water is coming out of the cooling water check port during warm up.

⚠ CAUTION

If the engine is operated without water discharging from the check port or idle port, the engine may over heat.

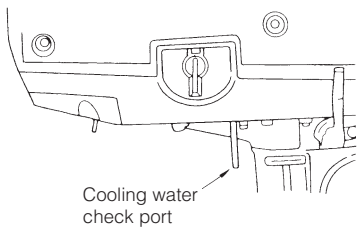

⚠ CAUTION

Be sure to stop engine immediately if cooling water check port is not discharging water, and check if cooling water intake is blocked. Operating engine could lead to overheating potentially leading to engine damage. Consult an authorized dealer if the cause cannot be found.

Engine speed

Idling speed after warming up.
 Remark: In case of cold engine starting, idling speed is increased about 300 rpm for several minutes.

Model	Clutch in (In gear)	Clutch off (Out of gear)
2.5A2	1,100 rpm	—
3.5A2	1,100 rpm	—
3.5B2	1,100 rpm	1,300 rpm

Propeller selection

Propeller must be selected that will allow the engine to reach recommended rpm when cruising at wide-open throttle.

Model	Wide-open throttle rpm range
2.5A2/3.5A2	3,800 - 5,200 rpm
3.5B2	4,200 - 5,300 rpm

Genuine propellers are listed on PROPELLER TABLE of this manual.

3. Forward and reverse

 **WARNING**

Before shifting into forward or reverse, make sure that boat is properly moored and outboard motor can be steered fully to the right and left. Make sure that no swimmer(s) is ahead or astern of the boat.

 **WARNING**

- Attach other end of emergency stop switch tether to the operator's clothing or arm and keep it attached during cruising.
- Do not attach the tether to a part of clothing that can be torn easily when pulled.
- Arrange the tether so that will not be caught by any object when pulled.
- Be careful not to pull the tether accidentally during cruising. Unintentional stop of engine can cause loss of control of outboard motor. Rapid loss of engine power can lead to falling down or causing passenger(s) to be thrown overboard.

 **CAUTION**

The shear pin breaks when the propeller is shocked, otherwise, the shear pin may break if shifting is done at a high motor speed.

Note

When moving astern, be sure to operate the motor at a low speed without unnecessary increase of the motor speed.

WARNING

Severe damage, and personal injury, may occur if shifting at high engine speed. Engine must be in the slow idle position before shifting is attempted.

5

Shifting to Forward (3.5B2 only)

Reduce the engine speed by the throttle lever down, and move the shift lever quickly to the “FORWARD” (F) position when the engine speed has reached the lowest rpm.

It may be dangerous to attempt shifting at high RPM. Be sure to slow down to trolling or idling rpm before shifting.

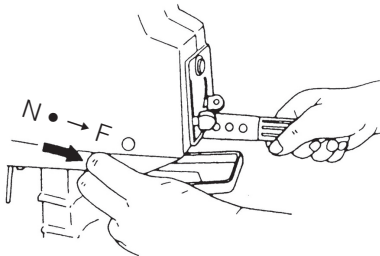

Reversing

Return the throttle lever to the “SLOW” position and when the engine speed has reached the lowest rpm, move the shift lever to the “NEUTRAL” (N) position. Stand the steering handle upright and turn the motor 180°. Move the shift lever to “FORWARD” (F) for reverse running. (3.5B2 only needs to operate shift lever)

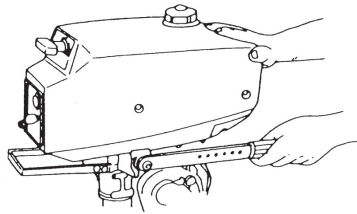

CAUTION

- Before shifting “FORWARD”, reduce the engine speed to the idling (low) speed. (3.5B2 only)
- It is dangerous to run at high speed while reversing. Be sure to operate the engine at low speed.
- If the motor hits an obstruction while reversing, the shock is directly applied to the motor and the boat. This may result in the driver and passengers being thrown out of the boat and may damage both the engine and the boat. Operate the engine carefully to avoid hitting any obstruction when reversing.

WARNING

Before shifting, make sure that no swimmer(s) or obstacle(s) is ahead or astern of the boat.

Speed Control

The speed is controlled by operating the throttle lever. Moving the throttle lever upward increases the speed, and moving it downward decreases the speed.

Driving in Shallow Water

When driving in shallows, operate the motor at the lowest speed paying careful attention to the depth of the water and obstacles.

WARNING

During shallow water operation, be careful not to place your hand between the swivel bracket and the stern bracket. Be sure to tilt the outboard down slowly.

WARNING

- Run at lowest possible speed during cruising using shallow water drive.
- When driving shallow water, be careful not to strike outboard motor against sea bottom, or propeller may be pushed out of water, resulting in loss of control.

WARNING

Do not tilt up or down outboard motor when swimmer(s) or passenger is near to prevent them from being caught between outboard motor body and clamp bracket in case the outboard motor body falls.

CAUTION

Do not tilt up outboard motor while engine operates, or no cooling water may be fed, leading to engine seizure due to overheating.

Note

Idle speed may be higher during warming up of engine. If shifted to Forward or Reverse during warming up, it may be difficult to shift back to neutral. In such case, stop engine, shift to neutral, and restart engine to warm up.

Note

Frequent shifting to forward or reverse can accelerate wear or degradation of parts. In such case, replace gear oil earlier than the period specified.

4. Stopping

- ① Reduce the engine speed to idling rpm, and release the lock of the stop switch or push the stop switch until the engine stops completely.

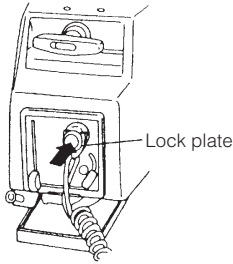

- ② Close the fuel cock and air vent screw on the fuel tank cap.

⚠ WARNING

Avoid serious injury or death from a gasoline fire or explosion. Ensure that is ②.

○ Notes

- After stopping the engine, close the air vent screw on the tank cap.
- Close the fuel cock. (Integral fuel tank)

⚠ WARNING

- This stop switch is provided for the safety of the driver. If the lock is released from the stop switch, the engine will stop. The engine will not start if the lock is in released condition. The emergency stop line should be connected to the driver's wrist, so that the engine will shut down if the emergency stop line is disconnected from the switch in the event of an accident such as the driver being thrown overboard or the boat capsizing.
- Be careful not to entangle the emergency stop line when operating the handle or while running in reverse. If the lock is released when running at high speed, the engine and the boat will stop suddenly. This is dangerous and may cause injury to the driver and passengers.

⚠ CAUTION

- The stop switch should be installed only by your dealer.
- Confirm that the stop switch works properly every the before boating.

5. Trim angle

The trim angle of the outboard motor can be adjusted to suit the transom angle of the hull, and load conditions. Choose an appropriate trim angle that will allow the anti ventilation plate to run parallel to the water surface during operation.

Proper trim angle

The position of the thrust rod is correct if the hull is horizontal during operation.

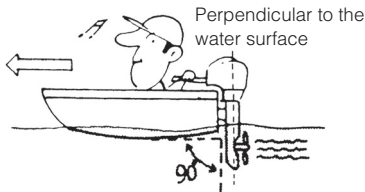

Improper trim angle

Set the thrust rod lower if the bow of the boat rises above horizontal.



Improper trim angle

Set the thrust rod higher if the bow of the boat is below horizontal.

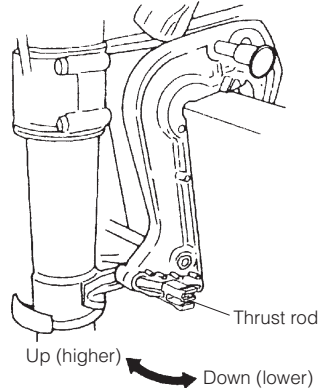

! WARNING

- Do not put hand or finger in between outboard motor body and clamp bracket when adjusting trim angle to prevent injury in case the outboard motor body falls.
- Unsuitable trim position can cause loss of control of boat. When testing a trim position, run boat slow initially to see if it can be controlled safely.

! WARNING

Excessive trim up or down may lead to unstable boat operation, potentially causing the steering difficulty that leads to accident during cruising.

- Do not cruise at high speed if improper trim position is suspected. Stop the boat and readjust trim angle before continuing cruise.

6. Tilt up and tilt down

WARNING

When tilting up or down, be careful not to place your hand between the swivel bracket and the clamp bracket. Be sure to tilt the outboard motor down slowly.

Note

Stop the engine before tilt-up or tilt-down operation.

5

Tilt up

- ① Close the fuel cock and air vent screw on the fuel tank cap.

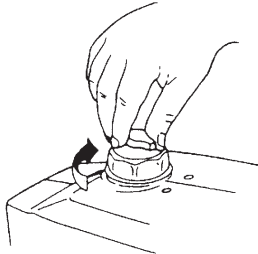

- ② After stopping the engine, tilt the outboard motor up fully toward you by hand and lock the tilt stopper knob in the tilt-up position on the clamp bracket.

CAUTION

Do not tilt up outboard motor during operation, or engine may be damaged from overheating due to lack of sufficient cooling water.

Tilt down

Pull the outboard motor fully toward you and release the tilt stopper knob from the tilt-up position.

WARNING

Do not tilt up or down outboard motor when swimmer(s) or passenger is near to prevent them from being caught between outboard motor body and clamp bracket in case the outboard motor body falls.

7. Outboard motor position in tilt up

When the outboard motor is in the tiltup position, the tilt handle side must be in the upward direction.

CAUTION

The outboard motor is set in the correct tilt-up position in the usual condition, however, the outboard motor may be set in the wrong tilt-up position if the motor direction is sharply changed in course of tilting up.

If the outboard motor is set in a wrong position, try to tilt it up once more to set it in the correct position.

8. Mooring the Boat

WARNING

When tilting up or down, be careful not to place your hand between the swivel bracket and the clamp bracket.

Be sure to tilt the outboard motor down slowly.

If the engine will not be operated for a period of time or the boat is moored in shallow water, tilt up the motor to prevent damage to the propeller, gear case, etc. due to hitting rocks in the water or low tide.

CAUTION

Tilt the motor up so that the propeller is facing upwards and secure the motor with the tilt stopper knob.

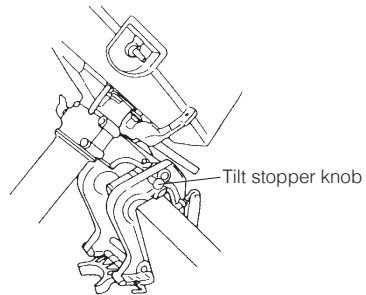

Be sure to close the fuel valve and tank cap breather before tilting up.

REMOVING AND CARRYING THE OUTBOARD MOTOR

1. Removing the outboard motor

- ① Stop the engine.
- ② Close the fuel cock and air vent screw.
- ③ Remove the outboard motor from boat and completely drain the water from the gear case.

CAUTION

Engine may be hot immediately after operating and could cause burns if touched. Allow Engine to cool down before attempting to carry the outboard.

2. Carrying the outboard motor

Keep the outboard motor in a vertical position when carrying.

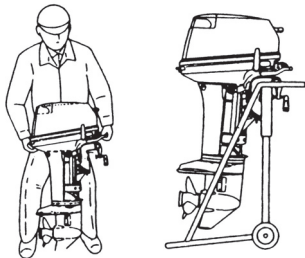

WARNING

Close air vent screw of fuel tank and fuel cock before carrying or storing outboard motor and fuel tank, or fuel may leak, potentially catching fire.

3. Storing the outboard motor

Outboard motor should be stored in a vertical position.

Note

If the outboard motor must be laid down be sure the tiller handle faces down as shown in the drawing below. Elevate power unit 2 inches to 4 inches if traveling to avoid oil spillage.

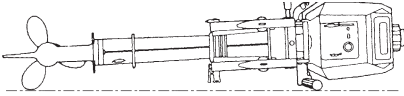

CAUTION

Do not carry or store outboard motor in any of positions described below. Otherwise, engine damage or property damage could result from leaking oil.

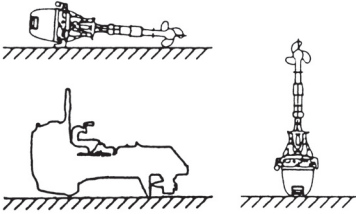

TRAILERING

! WARNING

Do not go under outboard motor tilted up even if it is supported by support bar, or accidental fall of outboard motor could lead to severe personal injury.

! WARNING

Close air vent screw of fuel tank and fuel cock before carrying or storing outboard motor and fuel tank, or fuel may leak, potentially catching fire.

! WARNING

When taking outboard motor from package or removing outboard motor from the boat, never release the lock lever. If the lock lever is released, it will very easy for the clamp bracket to spring up to the tilting direction because it is not fixed.

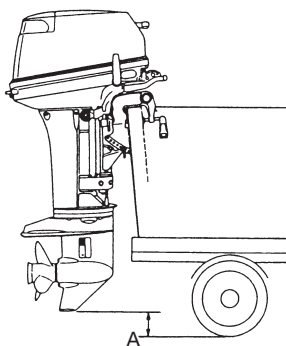

A: Ground clearance should be provided sufficiently.

! CAUTION

The tilt support device supplied on your outboard motor is not intended for towing. It is intended to support the outboard motor while the boat is docked, beached, etc.

ADJUSTMENT

1. Steering friction

The steering friction can be adjusted in accordance with your preference by turning the adjusting screw.

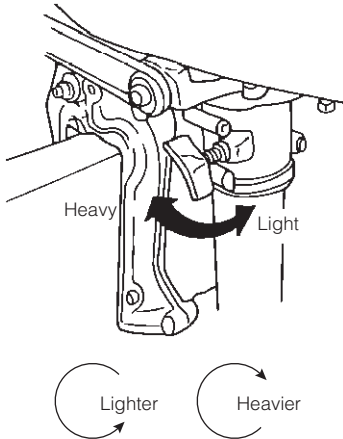

Note

The steering adjust screw is used to adjust the friction load of the steering, but not to fix the steering. Excess tightening of the adjustment screw may cause damage to the swivel bracket.

WARNING

Do not overtighten the throttle grip or remote control tensioner or it could result in difficulty of movement resulting in the loss of control causing an accident and could lead to severe injury.

INSPECTION AND MAINTENANCE

Care of your outboard motor

To keep your outboard motor in the best operating condition, it is very important that you perform daily and periodic maintenance as suggested in the maintenance schedules that follow.

CAUTION

- Your personal safety and that of your passengers depends on how well you maintain your outboard motor. Carefully observe all of the inspection and maintenance procedures described in this section.
- The maintenance intervals shown in the checklist apply to an outboard motor in normal use. If you use your outboard motor under severe conditions such as frequent full-throttle operation, frequent operation in brackish water, or for commercial use, maintenance should be performed at shorter intervals. If in doubt, consult your dealer for advice.
- We strongly recommend that you use only genuine replacement parts on your outboard motor. Damage to your outboard motor arising from the use of other than genuine parts is not covered under the warranty.

1. Daily inspection

Perform the following checks before and after use.



WARNING

Do not use outboard motor if any abnormality is found during pre-operation check or it could result in severe damage to the motor or severe personal injury.

Item	Points to Check	Action
Fuel System	<ul style="list-style-type: none"> • Check the amount of fuel in the tank. • Check for debris or water in the fuel filters. 	Replenish Clean or replace
Electrical Equipment	<ul style="list-style-type: none"> • Check that the stop switch functions normally and make sure the lock plate is there. • Check cords for loose connections and damage. • Check the spark plugs for dirt, wear and carbon build-up. 	Remedy or replace Correct or replace Clean or replace
Recoil Starter	<ul style="list-style-type: none"> • Check the rope for wear and chafing. • Check the ratchet engagement. 	Replace Correct or replace
Clutch and Propeller System	<ul style="list-style-type: none"> • Visually Check propeller for bent or damaged blades. • Check the propeller nut is tightened and the split pin is present. 	Replace
Installation of Motor	<ul style="list-style-type: none"> • Check all the bolts attaching the motor to the boat. • Check the thrust rod installation. 	Tighten Adjust
Cooling Water	<ul style="list-style-type: none"> • Check that cooling water is discharged from the cooling water check port after the engine has started. 	Repair
Tools and Spares	<ul style="list-style-type: none"> • Check that there are tools and spare parts for replacing spark plugs, the propeller, etc. • Check that you have the spare rope. 	
Anode	<ul style="list-style-type: none"> • Check if the anode is securely installed. • Check the anode for corrosion and deformation. 	Repair or Replace

Washing outboard motor

When the engine has been used in salt water or polluted water, wash the exterior and flush the cooling water passage with fresh water. The cooling water passage is flushed by placing the propeller section of the outboard in a bucket filled with fresh water, and operating the engine for about 3 minutes to circulate the water in the passage.

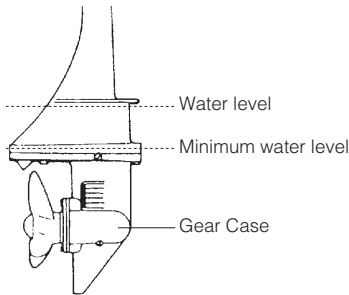

CAUTION

Keep cooling water passage free of clogs, or lack of cooling water flow could lead to engine overheating, potentially resulting in engine trouble.

Note

It is recommended to check chemical properties of water on which your outboard motor is regularly used.

WARNING

Do not start engine without removing propeller, or accidentally turning propeller could cause personal injury.

WARNING

Never start or operate the engine indoors or in any space which is not well ventilated. Exhaust gas contains carbon monoxide, a colorless and odorless gas which can be fatal if inhaled for any length of time.

CAUTION

- Set the shift lever to the “NEUTRAL” position before washing. (3.5B2 Only)
- When removing the propeller, remove the plug cap from the spark plug beforehand for safety.
- Wash the exterior of the outboard before long-term storage.
- Keep engine at idle speed during flushing.

■ Use flushing plug.

- ① Remove propeller (refer to Propeller Replacement). Remove the water plug from the outboard motor, and screw in the flushing plug.
- ② Attach a water hose to the flushing plug. Turn on the water and adjust the flow. (Be sure to seal the water inlet and sub water inlet, located in the gear case, with tape)
- ③ Insert a hose connected to a water tap into the flushing plug and let the water running.
- ④ Put the shift lever in the neutral position and start the engine.
- ⑤ Make sure of cooling water flowing out of water pump indicator hole and continue engine running for 3 to 5 minutes.
- ⑥ Stop the engine and water supply. Remove the flushing plug and tape, and then reinstall the water plug and the propeller.

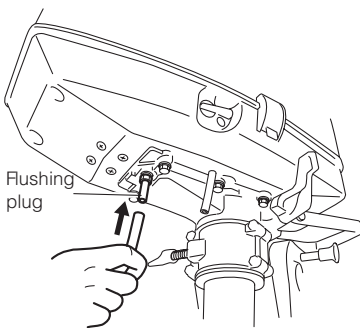
**⚠ CAUTION**

Keep engine at idle speed during flushing.

Replacing the propeller and shear pin

A worn-out or bent propeller will lower the motor's performance, and cause engine trouble.

Before removing the propeller, remove the spark plug caps from the spark plugs to protect against personal injury.

⚠ WARNING

Do not begin propeller removal and installation procedure with spark plug caps attached, shift in forward or reverse, main switch at other than "OFF", engine stop cord attached to the switch, and starter key attached, or engine could accidentally start leading to serious personal injury. Disconnect battery cable if possible.

- ① Pull out the split pin from the propeller boss and remove the propeller from the shaft.
- ② Remove the shear pin from the shaft.
- ③ Install a new shear pin.

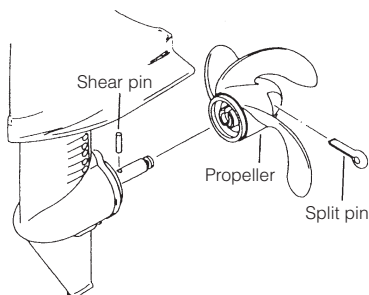

⚠ WARNING

Do not hold propeller with hand(s) when loosening or tightening propeller nut. Put a piece of wood block between propeller blade and anti ventilation plate to hold propeller.

○ Notes

- When removing the plug cap cover, take care not to drop it into the water.
- In order to protect propeller and gears from damage, shear pin is designed so as to be broken when propeller gets strong impact or when the shear pin is used for a longer period of time.
- Always carry a spare split pin and shear pin. When the spare has been used, supply a new one. A damaged or worn split pin or shear pin should be replaced with a new one.

⚠ CAUTION

- Do not reuse split pin.
- After installing split pin, spread the pin apart to prevent it from falling out which could lead to the propeller coming off during operation.

Replacing the spark plugs

WARNING

- Do not reuse spark plug with damaged insulation, or sparks can leak through crack, potentially leading to electric shock, explosion and/or fire.
- Do not touch spark plugs immediately after stopping engine as they will be hot and could cause severe burns if touched. Allow motor to cool down first.

If the spark plug(s) is fouled, has carbon build up, or is worn, it should be replaced.

When reusing spark plugs, remove dirt from the electrodes and adjust spark gap to specification.

Note

When inspecting the plug, always clean the gasket surface and use a new gasket. Wipe off any dirt from the threads and screw in the spark plug to the correct torque.

- ① Stop the engine.
- ② Remove the top cowl.
- ③ Remove the spark plug caps.
- ④ Remove the spark plugs by turning it counter-clockwise, using a 21 mm (13/16 in) socket wrench and handle.

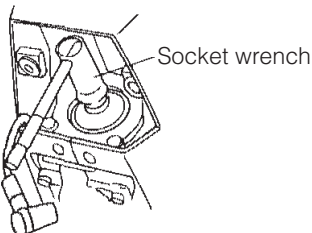

- ⑤ Attach spark plug and tighten to specified torque.

Use spark plugs (NGK BP6HS-10 or BP6RHS-10) or recommended ones.

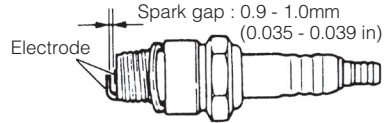

Note

Tighten the spark plug by 1/2 - 3/4 turn to secure it after it touches the washer on the cylinder head.

Note

- Spark plug torque :
27.0 Nm (20.0 ft-lb) (2.7 kgf-m)
- If a torque-wrench is not available when you are fitting a spark plug, a good estimate of the correct torque is 1/4 to 1/2 a turn past finger-tight. Have the spark plug adjusted to the correct torque as soon as possible with a torque-wrench.

WARNING

Never remove the plug cap cover when the engine is running. It is dangerous to touch the high-tension cable inside the plug cap cover.

Replacing the anode

A sacrificial anode protects the outboard motor from galvanic corrosion. Anode is located on the gear case, clamp bracket and the cylinder. When the anode is eroded more than 2/3, replace it.

Notes

- Never grease or paint the anode.
- At each inspection re-tighten the anode attaching bolt. As it is likely to be subjected to electrolytic corrosion.

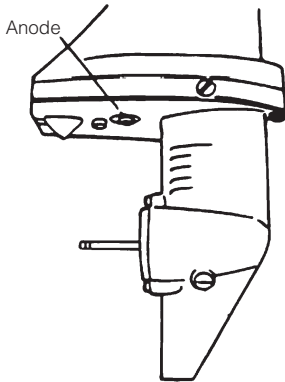

WARNING

- Be sure that outboard motor is secured to transom or service stand, or accidental drop or fall of outboard motor could lead to severe personal injury.
- Be sure to lock outboard motor if it is tilted up, or accidental fall of outboard motor could lead to severe personal injury.
- Do not go under outboard motor tilted up and locked, or accidental fall of outboard motor could lead to severe personal injury.

2. Periodic inspection

It is important to inspect and maintain your outboard motor regularly. At each interval on the chart below, be sure to perform the indicated servicing. Maintenance intervals should be determined according to the number of hours or number of months, whichever comes first.

Item		Servicing Interval			Action	Remarks
		10 hours or 1 month	50 hours or 3 months	Every 100 hours or 6 months		
Fuel system	Carburetor*	●		●	Clean, and adjust.	
	Fuel filter	●	●	●	Check and clean or Replace.	
	Piping			●	Check and Replace.	
	Fuel tank	●	●	●	Clean.	
Ignition	Spark plugs	●	●	●	Check gaps. Remove carbon deposits or Replace.	
Starting system	Starter rope	●	●	●	Check for wear or chaffing.	
Lower unit	Propeller	●	●	●	Check for bent blades, damage, wear.	
	Shear pin & Split pin	●	●	●	Check and Replace.	
	Gear oil	●	●	●	Replace or Fill gear oil and check for water leaks.	
	Water pump*			●	Check for wear or damage.	
Bolt and nuts		●	●	●	Retighten.	
Sliding and rotating parts. Grease Nipples			●	●	Apply and pump in grease.	
Outer equipment		●	●	●	Check for corrosion.	
Anode			●	●	Check for corrosion and deformation.	

*Have this handled by your dealer.

Note

Your outboard motor should receive careful, and complete, inspection at 300 hours. This is the best time for major maintenance procedures to be carried out.

Replacing gear oil

⚠ WARNING

- Be sure that outboard motor is secured to transom or service stand, or accidental drop or fall of outboard motor could lead to severe personal injury.
- Be sure to lock outboard motor if it is tilted up, or accidental fall of outboard motor could lead to severe personal injury.
- Do not go under outboard motor tilted up and locked, or accidental fall of outboard motor could lead to severe personal injury.

- ① Remove the oil plugs (upper and lower), and completely drain the gear oil into a pan.
- ② Insert the oil tube nozzle into the lower oil plug hole, and fill with gear oil by squeezing the oil tube until oil flows out of the upper plug hole.
- ③ Install the upper oil plug, and then remove oil tube nozzle and install the lower oil plug.

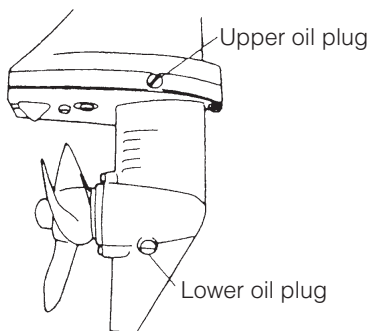

⚠ CAUTION

Do not reuse oil plug gasket. Always use new gasket and tighten oil plug properly to prevent entry of water into lower unit.

⚠ CAUTION

Treat the drained gear oil in the proper way as an industrial waste.

○ Note

If water in the oil, giving it a milky colored appearance. Contact your dealer.

○ Note

Use genuine gear oil or the recommended one (API GL-5: SAE #80 to #90).

Required volume

: approx. 180 mL (6.08 U.S. fluid oz)
3.5B2

: approx. 90 mL (3.04 U.S. fluid oz)
2.5A2/3.5A2

3. Off-season storage

Before you put your outboard motor in storage, it is a good opportunity to have it serviced and prepared by your dealer.

CAUTION

Before servicing the motor for storage:

- Remove the spark plug caps from the spark plugs.
- Do not run the motor out of the water.

- ① Wash the engine exterior and Flush the cooling water system thoroughly with fresh water. Allow the water to drain completely. Wipe off any water on the surface with an oil rag.
- ② Drain all fuel from the fuel pipes, fuel cock and carburetor, and clean the parts including the mesh in the fuel cock.
- ③ Disassemble the carburetor, remove any internal dust, and clean it using gasoline and air.
- ④ Remove the spark plug and feed engine oil or storage fogging oil through the spark plug hole. Pull the recoil starter handle a few times to circulate the oil to the internal parts.
- ⑤ Apply grease to the propeller shaft.
- ⑥ Change the gear oil in the gear case.

- ⑦ Apply grease to all sliding parts, bolts and nuts.
- ⑧ Wipe off any water and salt on the electrical components using a dry cloth.
- ⑨ Stand the outboard vertically in a dry and ventilated place.

WARNING

Be sure to use cloth to remove fuel remaining in the cowl and dispose of it in accordance with local fire prevention and environment protection regulations.

Note

Treat the fuel and oil drained from the fuel tank, carburetor, gear case, etc. in the proper way.

4. Pre-season check

- ① When using the outboard motor for the first time after a long period of storage, it is recommended to:
 - warm-up the engine for about 3 minutes.
 - run the engine at slow speed for about 5 minutes, then.
 - run the engine at medium speed for about 10 minutes.
- ② Use fresh fuel mixed at a ratio of 25:1.

5. Motor submerged in water

After taking your outboard motor out of the water, immediately take it to your dealer.

The following are the emergency measures to be taken for a submerged outboard motor, if you can not take it your dealer right away.

- ① Take it out of the water immediately and wash it with fresh water to remove all traces of salt and dirt.
- ② Remove the spark plug, and drain the engine completely of water. Turn the flywheel several times by pulling the starter rope handle to drain any remaining water in the engine.
Drain the fuel line and the carburetor.
Inject a plentiful amount of engine oil or storage fogging oil into the engine through the spark plug hole and the air silencer.
- ③ After the above steps, it may be possible to start the engine. However, the electrical components and carburetor will soon deteriorate and become inoperative. Therefore, be sure to have the engine overhauled by your dealer as soon as possible.

 **CAUTION**

Do not attempt to start submerged outboard motor immediately after it is recovered, or engine could be severely damaged.

6. Cold weather precautions

If you moor your boat in cold weather at temperatures below 0°C (32°F), there is the danger of water freezing in the cooling water pump, which may damage the pump, impeller, etc. To avoid this problem, submerge the lower half of the outboard motor into the water, or tilt the motor up above water level and pull the recoil starter several times to drain the water completely.

7. Checking after striking underwater object

Striking the sea bottom or an underwater object may severely damage the outboard motor. Immediately bring the outboard motor to the dealer and ask for the following checks.

- ① Looseness or damage of power unit installation bolts, gear case and extension case bolts, propeller shaft housing bolts, propeller or propeller shaft upper and lower mount rubber bolts, and/or mount bracket bolts.

Ask an authorized dealer to tighten any loose bolts and nuts, and to replace damaged parts.
- ② Damage to mount rubber, the tilt stopper, thrust rod, gears and clutch, and/or propeller.

Ask an authorized dealer to replace damaged or defective parts.

TROUBLESHOOTING

If you encounter a problem, consult the check list below to determine the cause and to take the proper action.

An authorized dealer will always be happy to provide any assistance and information.

		Engine failing to start	Engine starting but stopping soon	Poor idling	Engine speed abnormally high	Engine speed abnormally low	High engine speeds not possible	Overheating of engine	Possible cause
FUEL SYSTEMS	●	●							Empty fuel tank
	●	●							Incorrect connection of fuel system
	●	●	●		●	●	●		Air entering fuel line
	●	●	●		●	●	●		Deformed or damaged fuel pipe
	●	●	●		●	●	●		Closed air vent on fuel tank
	●	●	●		●	●	●		Clogged fuel filter, fuel pump, or carburetor
			●		●	●	●		Use of improper engine oil
	●		●		●	●	●		Use of improper gasoline
			●		●	●			Excessive oil in mixture
							●		Shortage of oil in mixture
	●								Excessive supply of fuel
	●	●	●		●	●	●		Poor carburetor adjustment

		Engine failing to start	Engine starting but stopping soon	Poor idling	Engine speed abnormally high	Engine speed abnormally low	High engine speeds not possible	Overheating of engine	Possible cause
ELECTRIC SYSTEMS	●	●	●		●	●	●	Spark plugs other than specified	
	●	●	●		●	●		Dirt, soot, etc. on spark plugs	
	●	●	●		●	●		No spark or weak spark	
	●							Short circuit of engine stop switch	
	●							Lock plate not fitted to stop switch	
OTHERS				●				Sheared shearpin	
					●	●	●	Insufficient cooling water flow, clogged or defective pump	
				●		●	●	Cavitation or ventilation	
				●	●	●	●	Incorrect propeller selection	
			●	●	●	●	●	Damaged and bent propeller	
				●		●	●	Improper thrust rod position	
				●	●	●	●	Unbalanced load on boat	
			●	●	●	●	Transom too high or too low		

■ TOOL KIT AND SPARE PARTS

The following a list of the tools and spare parts provided with the motor.

Items		Quantity	Remark
Service Tools	Tool Bag	1	21mm No. 2
	Pliers	1	
	Socket Wrench	1	
	Socket Wrench Handle	1	
	Phillips Screwdriver	1	
Spare Parts*	Spark Plug	1	NGK BPR6HS-10
	Shear pin	1	
	Split Pin	1	
	Rope	1	

* Not provided with the motor in some markets.

OPTIONAL ACCESSORIES

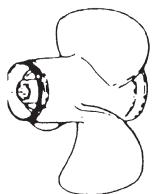

Propeller

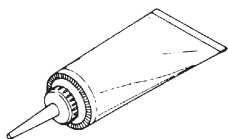

Genuine gear oil (500mL)



Flushing plug



Touch-up Paint

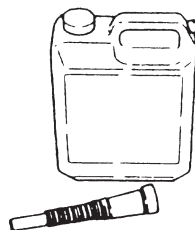

Genuine Engine Oil (0.4L, 1L, 4L, 20L)

■ PROPELLER TABLE

Use a genuine propeller.

A propeller must be selected so that the engine rpm measured at wide open throttle while cruising is within the recommended range.

Model	2.5A2	3.5A2	3.5B2
Propeller 4.5 (Plastic)	OP	–	–
Propeller 6 (Plastic)	STD	STD	OP
Propeller 6 (Aluminum)	OP*	OP*	OP*
Propeller 7 (Plastic)	–	OP	STD

O : Option / STD : Standard

* A stainless steel shear pin must be used.



OWNER'S MANUAL
M 2.5A2
3.5A2
3.5B

TOHATSU CORPORATION

Address : 5-4, 3-chome, Azusawa, Itabashi-ku,
TOKYO, 174-0051 JAPAN

Phone : TOKYO (03)3966-3117

FAX : TOKYO (03)3966-2951

Website : www.tohatsu.co.jp