





Genuine Yamaha parts and accessories. Why choose anything else?

Yamaha is a name synonymous with performance, quality and reliability - and behind it is a reputation earned from years of creating outboard engines and marine products which incorporate the most advanced and innovative technology. In fact, millions of water sports enthusiasts and professionals the world over choose Yamaha, simply because it's the name they know and trust - and because they know we apply the very same high standards and attention to detail to everything we make. So it's no surprise that they also choose Yamaha when it comes to their parts and accessories. What's more, all our products are designed to work seamlessly with each other, which means not just co-ordinated design, looks and styling, but more dependable performance and a comforting feeling of peace of mind.

There's an impressively wide range too, extending from exciting watersport accessories, smart steering wheels and high-performance props - to hi-tech marine lubricants, ingenious security locks and protective covers for engines and watercraft. Not to mention remote controls and steering systems, switches, filters, fuel tanks and other practical things! Check out too, our line-up of Digital Network Gauges and electronic control systems - with its integral, centrally-managed system of command and control, comes a revolution in boating comfort and enjoyment.

So whatever you may need to enhance your fun and enjoyment on the water, we've got it covered - with products that are designed to perform and built to last. Just as you'd expect from Yamaha.



Propellers

Propeller Information	2
Series description	3
Selection guide by model	6

Outboard Rigging & Accessories

Helm Master	14
Instruments	18
Remote controls	22
Switch panels	28
Rigging Kits	30
Harnesses	36
Tiller handle	39
YCOP & accessories	40
Steering & Steering Systems	41
Filters & Fuel Accessories	44
Other Rigging & Accessories	47
Anodes, Impellers, Thermostats	54
Fuel & Oil Filters, Spark Plugs	55

Rigging Order Guide	58
---------------------	----

Yamalube	91
----------	----

WaveRunner Accessories	106
------------------------	-----

Fun on the Water	110
------------------	-----

Apparel

Marine WaveRunner wetsuits	112
Marine WaveRunner apparel	113
Marine race wetsuits	114
Marine Casual	115
REVS	117
Merchandize	121
Yamaha Motor Dealer Shop Wear	125

Propellers and Propeller Accessories



PROPELLER INFORMATION

THE PROPELLER MAKES ALL THE DIFFERENCE.

If you haven't tried one of Yamaha's comprehensive range of propeller solutions, you're not getting the most out of your outboard. In fact, the right Yamaha propeller can maximize your outboard's acceleration, top speed, fuel economy and lifespan, all while providing a quieter ride and better handling. No matter what your application, there's a genuine Yamaha propeller that can help you achieve peak performance.

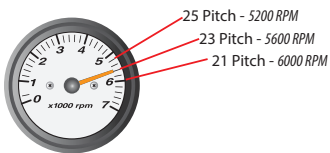

PITCH

Pitch is the 'theoretical' distance (in inches) a propeller would travel in one full revolution, if it were travelling through solid matter. A prop with low pitch will deliver better acceleration/hole shot and pushing power but a lower top speed, while a higher pitch prop will provide less thrust, but with a higher top speed. The correct propeller will allow your engine to reach the upper portion of the W-O-T range specified by the manufacturer with a normal-to-heavy load, but without exceeding it. Each inch of pitch is equal to approximately 150 +/- 50 RPM.

DIAMETER

Diameter means the total width of the "circle" at the blade tips as the propeller spins. Larger diameter props push more water and reach deeper down into the water, so they're typically used on large, heavy boats or ones with higher-placed engine mountings. A smaller diameter prop is usually used on lighter boats, where the prop operates closer to the surface of the water - or when you need a higher engine RPM.

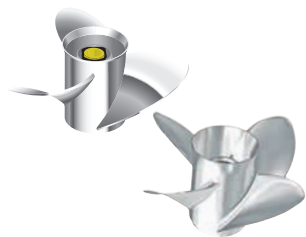
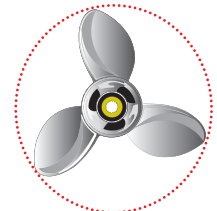

NUMBER OF BLADES

Three-bladed propellers are the most common, offering good overall performance, top speed, and efficiency for most applications. While a four-bladed prop will provide increased bow and stern-lift and reduce prop ventilation, this normally means more drag on the engine, resulting in lower top speeds and different handling characteristics.

BLADE GEOMETRY

Blade geometry refers to the actual shape of the blade (or ear). By manipulating the blade's shape, diameter and pitch progression, different performance characteristics can be created for each different type and style of propeller.

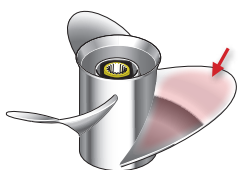
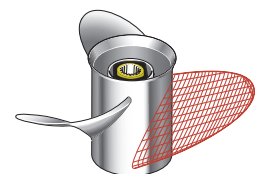

BLADE SURFACE AREA

Blade surface area refers to the total surface of the blades. The greater the blade surface area, the more water the prop pushes, for better hole shot and increased planing efficiency. However, too much blade area can create significantly more drag, potentially restricting engine RPM and causing negative boat-handling issues.

CUP

Cup is the small curved lip on the blade tip and/or trailing edge. Used in proper amounts, cup helps reduce ventilation and propeller slippage, allowing for higher engine mounting and greater bow lift. However, too much cup may cause excessive steering torque and bow lift - and limit the engine's ability to develop and maintain proper RPM at a certain pitch.

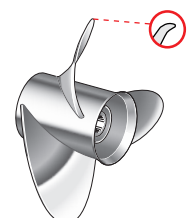

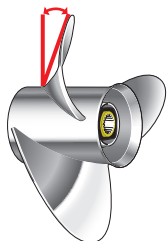

RAKE

Rake is the angle of the blade in relation to the propeller's barrel, or centre, and is expressed in degrees. A high rake propeller is best suited to applications where the engine is mounted high, to help reduce ventilation and increase bow lift. However, too much rake can strain the engine, decrease hole shot and produce negative performance and handling results. A propeller with a low rake angle will cause less strain on the engine, resulting in potentially better hole shot and higher operating rpm at W-O-T.

SDS - SHIFT DAMPENER SYSTEM

Reducing the annoying shift shock and noise normally associated with moving between gears, Yamaha's unique Shift Dampening System (SDS) uses a splined aft washer and a splined rubber hub to absorb noise and vibration. This carefully engineered solution brings smoother, quieter gear shifts.

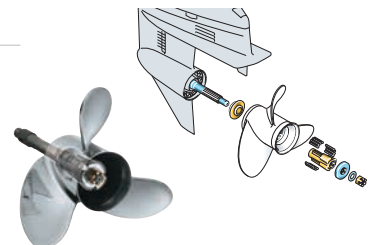

PROPELLER SERIES

ALUMINUM/PLASTIC SERIES

Offering Yamaha design, quality and performance in a low-cost, lightweight propeller. this is a good all-around choice for your Yamaha outboard. Available in a wide variety of sizes and pitches for Yamaha outboards between 2 and 225 horse power, in right-hand and select left-hand rotation.



DUAL THRUST SERIES

Specially designed for sailboats and other large-displacement craft, Yamaha's patented Dual Thrust propellers are built to handle the job of pushing heavy loads through water. The hub is carefully designed to redirect exhaust flow away from the blades, so Dual Thrust models cut through "clean water" for higher efficiency and better acceleration. It is recommended that you contact an authorised Yamaha Dealer for advice on installation.



TALON GP SERIES (WITH SDS)

Designed for outboards from F70 to F130. Our Talon – SDS propeller with our exclusive Shift Dampener System (SDS™) brings a better top speed while offering a comfortable ride. The smooth shifting and quiet, in-gear operation, even at trolling speeds, will be particularly beneficial on smaller, in-line outboards.



TALON SERIES (WITH SDS)

Specially engineered to reduce ventilation and enhance bow lift, Yamaha's TALON aluminum 3-bladed propellers offer excellent holding power in turns, with enhanced "grip" for improved control. In addition, they feature better overall performance and greater cruising efficiency in a planed trim position than conventional 3-bladed aluminum propellers. TALON props are especially effective on mid-sized deep- and mod-V aluminum boats, particularly in applications with the potential for aerated water beneath the boat. The Yamaha SDS mechanism is integrated to reduce shifting vibration and noise. Can be used with standard spacer.





BLACK STAINLESS STEEL SERIES

An excellent general-purpose choice, these props are made from stainless steel, with a cost-effective black paint coating, allowing for a blade that is thinner, more efficient and more durable than an aluminum propeller. Available in a wide variety of sizes and pitches for Yamaha outboards between 25 and 300 horse power, in right-hand and select left-hand rotation.



RELIANCE SERIES (WITH SDS)

Reliance is CAD-designed to increase performance. Designed primarily for use with Yamaha's F150 and F200 in-line 4 outboards, it also provides excellent all-around performance. Faster at all RPM ranges and having better anti-ventilation characteristics (grip) in most applications than Yamaha's proven Black Stainless Steel props, Reliance Series props are highly-polished stainless steel, featuring impressive cast-in naming on the barrel and excellent corrosion resistance. Now available with Yamaha's exclusive Shift Dampener System (SDS).



SALTWATER SERIES II (WITH SDS)

A powerful choice for today's larger offshore boats, Saltwater Series II propellers are a highly-polished, larger diameter design. Aggressive rake and extra cupping on the blades provide superior midrange fuel efficiency, along with excellent anti-ventilation characteristics. For offshore fishermen, that translates to longer cruising range and better handling in rough seas. Also available with the Yamaha Shift Dampener System (SDS).



SALTWATER SERIES HS4 (WITH SDS)

A polished stainless steel propeller with 4 blades, for certain V6 4-stroke engines. Compared with the conventional 3-bladed propeller, the 4-blade configuration has a larger blade surface area, which can catch much more water and obtain higher thrust performance. As a result, this propeller will obtain better acceleration and be more stable in operation under rough water. However, top speed performance is generally slightly less than a 3-blade design. L/H rotation propellers are available.



SALTWATER SERIES XL

A premium prop designed exclusively for the V8 5.3L 4-stroke Yamaha outboards. Designed to harness the awesome power of these engines and convert it into massive amounts of thrust, Saltwater XL propellers have more diameter and 21% more blade area than even our largest Saltwater Series II propellers. This helps the F350 generate up to 45% more thrust than other 250hp-class outboards, and provides large offshore boats with plenty of power to plane quickly, as well as great acceleration and top-end speed. Available with the SDS Shift Dampening System. (Note: deduct two inches of pitch for same or similar performance when converting non-SDS XL propellers to SDS-equipped Saltwater Series XL propellers.)

SALTWATER SERIES XL4 AND XL4-HP (WITH SDS)

Designed exclusively for Yamaha's V8 5.3L F350 outboard, this 4 bladed prop offers incredible thrust and quick-on-the-plane capability, yet with quiet and smooth operation thanks to Yamaha's unique SDS Shift Dampener System. Two XL4 prop types are available: XL4 (15" and 17") designed for very large, heavy offshore boats - and the XL4-HP (22" and 24") designed for lighter, high-performance multi-engined offshore boats.



XTO OS™ (SDS) PROPELLERS

With diameters from 16 to 17 1/8 inches and increased blade surface, XTO OS™ propellers are engineered to complement the torque potential of our V8 XTO Offshore™ outboard on 50-foot-plus boats. Features our patented, Shift Dampener System (SDS) for a smoother ride.



Propellers

ALUMINUM SERIES

Outboard Model	Part Number	Diameter	Pitch	Blade	Hub	Rotation	Price	Remark
2A/2B/2C	6A1-45943-00-00	7 1/4	4	3	A	RH		
	646-45944-01-00	7 1/4	4 1/2	3	A	RH		
	6F8-45942-01-00	7 1/4	5	3	A	RH		
	646-45942-01-00	7 1/4	5 1/2	3	A	RH		
F2,5A 3A	6L5-45949-00-00	7 1/4	5	3	BS	RH		
	6L5-45952-00-00	7 1/2	5 1/2	3	BS	RH		
	6L5-45943-00-00	7 1/4	6	3	BS	RH		
	6L5-45945-00-00	7 1/4	7 1/4	3	BS	RH		
	6L5-45947-00-00	7 1/4	8 1/4	3	BS	RH		
4A / 5C (-1991)	644-45941-01-00	7 1/4	5	3	B	RH		
	654-45941-01-00	7 1/4	6 1/2	3	B	RH		
	6E0-45943-09-00	7 1/2	7	3	B	RH		
	654-45943-01-00	7 1/4	7 1/4	3	B	RH		
	6E0-45941-09-00	7 1/2	8	3	B	RH		
	6E0-45947-00-00	7 1/4	8 1/4	3	B	RH		
F4A / F4B / F5A / F6C 4A / 5C (1992--)	6E0-45949-00-00	7 1/4	6 1/2	3	BA	RH		
	6E0-45943-01-00	7 1/2	7	3	BA	RH		
	6E0-45941-01-00	7 1/2	8	3	BA	RH		Spline engagement
	6E0-45952-00-00	7 1/4	8 1/4	3	BA	RH		
	6E0-45954-00-00	7 1/2	9	3	BA	RH		
6A / 6B / 8A / 8B / E8D	655-45949-00-00	7 1/4	5	3	C	RH		
	655-45947-01-00	9	5 3/4	3	C	RH		
	655-45945-00-00	9	6 1/2	3	C	RH		
	647-45943-00-00	9	7	3	C	RH		
	655-45943-00-00	9	7 1/2	3	C	RH		
	647-45947-00-00	9	9	3	C	RH		
	647-45941-00-00	9 1/4	9 1/4	3	C	RH		
F6A / F8C / F9,9F / F9,9J 6C / 8C	6G1-45947-00-00	8 1/2	6 1/2	3	N	RH		
	6G1-45943-00-00	8 1/2	7 1/2	3	N	RH		
	6G1-45952-00-00	8 1/2	8	3	N	RH		
	6G1-45941-00-00	8 1/2	8 1/2	3	N	RH		
	6G1-45954-00-00	8 1/2	9 1/4	3	N	RH		
F8B / F9,9B / F9,9C / F15A / F15C 9,9D / 15D / 9,9F / 15F	683-45949-00-00	9 1/2	6 1/2	3	J	RH		
	63V-45947-00-00	9 1/4	8	3	J	RH		
	683-45952-00-00	9 1/4	9 3/4	3	J	RH		
	683-45943-00-00	9 1/4	10 1/2	3	J	RH		
F8B / F9,9B / F9,9C / F15A / F15C / F20B / 9,9D / 15D / 9,9F / 15F	683-45941-00-00	9 1/4	12	3	J	RH		
	63V-45945-10-00	9 1/4	9	3	J1	RH		
	63V-45952-10-00	9 1/4	10	3	J1	RH		
	63V-45943-10-00	9 1/4	11	3	J1	RH		
	63V-45941-10-00	9 1/4	12	3	J1	RH		
F25A / F25D / F25G 20C / 20D / 25B / 25D / 25N / 25V / 30A / 30D / 30G	664-45943-01-00	9 7/8	8	3	F	RH		
	664-45941-01-00	9 7/8	9	3	F	RH		
	62C-45941-00-00	9 7/8	10	3	F	RH		
	664-45945-00-00	9 7/8	10 1/2	3	F	RH		
	664-45947-01-00	9 7/8	11 1/4	3	F	RH		
	664-45954-01-00	9 7/8	12	3	F	RH		
	664-45949-02-00	9 7/8	13	3	F	RH		
F30A / F30B / F40A / F40B / F40F / F50A / F50F / F50H / F60A / F60C / F60F 40H / 40V / 40Q / 40X / 50D / 50G / 50H / PRO 50 / 55B	664-45952-00-00	9 7/8	14	3	F	RH		
	63D-45941-00-00	12 1/4	8	3	G	RH		
	663-45956-01-00	12 1/4	9	3	G	RH		
	663-45954-01-00	11 3/4	10	3	G	RH		G-series all-rounder
	663-45958-01-00	11 1/4	14	3	G	RH		
	663-45949-01-00	10 3/4	16	3	G	RH		
	69W-45947-00-00	11 5/8	11	3	G	RH		
	69W-45952-00-00	11 3/8	12	3	G	RH		
	69W-45945-00-00	11 1/8	13	3	G	RH		G-series commercial & durable propeller
	69W-45958-00-00	11 1/4	14	3	G	RH		
	69W-45943-00-00	11	15	3	G	RH		
6H5-45952-00-00	6H5-45952-00-00	10 5/8	12	3	G	RH		
	6H5-45945-00-00	10 3/8	13	3	G	RH		
	6H5-45958-00-00	10 1/4	14	3	G	RH		G-series for light boat
	6H5-45943-00-00	10	15	3	G	RH		

ALUMINUM SERIES

F70A / F80A / F80B /	6E5-45954-00-00	14	11	3	K	RH		
F100A / F100D / F100F /	6E5-45949-00-00	13 5/8	13	3	K	RH		
F115A / F115B	6E5-45958-00-00	13 5/8	14	3	K	RH		
60F / 70B / 75A / 75C	6E5-45947-00-00	13 1/2	15	3	K	RH		
/ PRO75 / 80A / 85A /	6E5-45945-01-00	13 1/4	17	3	K	RH		
90A / 100A / PRO V 100	6E5-45941-00-00	13	19	3	K	RH		
/ 115A / 115B / 115C /	6E5-45943-00-00	12 5/8	21	3	K	RH		
130A / 130B / 140A /	6E5-45952-00-00	13	23	3	K	RH		
140B / 140C	6E5-45956-00-00	13	25	3	K	RH		
F150A / F150D / F175A	6G5-45941-00-00	15 1/4	15	3	M	RH		
/ F200A / F200C / F200F	6G5-45952-00-00	14 5/8	16	3	M	RH		
/ F200G	6G5-45947-01-00	14 1/2	17	3	M	RH		
150A / 150C / 150F /	6G5-45945-01-00	14	19	3	M	RH		
Z150P / 175A / 175B /	6G5-45943-01-00	13 3/4	21	3	M	RH		
175D / Z175G / 200A /	6G5-45949-00-00	13 1/2	23	3	M	RH		
200B / 200F / Z200N								
FL150A / FL150D /	6K1-45947-00-00	14 1/2	17	3	ML	LH		
FL200C / FL200F /								
FL200G / L150A / L150C /	6K1-45945-00-00	14	19	3	ML	LH		
L150F / LZ150P / L200A /								
L200B / L200F / LZ200N								

DUAL THRUST SERIES (ALUMINUM)

Outboard Model	Part Number	Diameter	Pitch	Blade	Hub	Rotation	Price	Remark
6C / 8C	6G1-W4592-00-00	9	5	3	N	RH		
F6A / F8C / F9,9F / F9.9J	6G1-W4591-01-00	9	7	3	N	RH		
F8B / F9,9B / F9,9C / F15A / F15C /	683-W4592-02-00	9 3/4	6 1/2	3	J	RH		
F20B / 9,9D / 15D / 9,9F / 15F	683-W4591-02-00	9 3/4	8	3	J	RH		
FT8D	69G-45941-00-00	11 3/4	5 3/4	3	R	RH		
	69G-45943-00-00	11 3/4	7	3	R	RH		
FT9.9A/D/G/L	6G8-45947-00-00	11 3/4	9 1/4	3	R	RH		
F25A/G	6J8-W4591-00-00	10 5/8	8 1/2	3	F	RH		
FT25B / FT25F	68U-45941-00-00	12 1/4	9	3	G	RH		
FT50B / FT50C / FT50G / FT50J /	68S-45941-00-00	14	11	3	K	RH		
FT60B / FT60D / FT60G								

TALON GP SERIES - SDS (ALUMINUM)

Outboard Model	Part Number	Diameter	Pitch	Blade	Hub	Rotation	Price	Remark
	6FP-45941-00-00	13 5/8	14	3	K	RH		2017
	6FP-45943-00-00	13 1/2	15	3	K	RH		2017
F70A / F80A / F80B / F100A / F100D /	6FP-45945-00-00	13 1/4	16	3	K	RH		2017
F100F / F115A / F115B / F130A	6FP-45947-00-00	13 1/8	17	3	K	RH		2017
	6FP-45949-00-00	13	18	3	K	RH		2017

TALON SERIES (ALUMINUM)

Outboard Model	Part Number	Diameter	Pitch	Blade	Hub	Rotation	Price	Remark
60F / 70B / 75A / 75C / PRO75 / 80A /	6EK-45941-00-00	13 1/2	9	3	K	RH		
85A / 90A / 100A / PRO V 100 / 115A	6EK-45943-00-00	13 1/2	10 1/2	3	K	RH		
/ 115B / 115C / 130A / 130B / 140A /	6EK-45945-00-00	13 1/2	12	3	K	RH		
140B / 140C	6EK-45947-00-00	13 1/2	14	3	K	RH		
F70A / F80A / F80B / F100A / F100D /	6EK-45949-00-00	13 1/2	16	3	K	RH		
F100F / F115A / F115B								

STAINLESS STEEL SERIES

Outboard Model	Part Number	Diameter	Pitch	Blade	Hub	Rotation	Price	Remark
F25A / F25D / F25G	664-45972-00-00	9 1/8	12	3	F	RH		
20C / 20D / 25B / 25D / 25N / 25V /	664-45970-00-00	9 1/8	13	3	F	RH		
30A / 30D / 30G								

Propellers

BLACK STAINLESS STEEL SERIES

Outboard Model	Part Number	Diameter	Pitch	Blade	Hub	Rotation	Price	Remark
	663-45972-60-00	12	11	3	G	RH		
F30A / F30B / F40A / F40B / F40F / F50A / F50F / F50H / F60A / F60C / F60F	663-45970-60-00	11 3/4	12	3	G	RH		
	663-45974-02-00	10 5/8	13	3	G	RH		
	663-45974-60-00	11 1/2	13	3	G	RH		
40H / 40V / 40Q / 40X / 50D / 50H / 50G / PRO50 / 55B	663-45930-00-98	10 1/4	14	3	G	RH		
	663-45976-00-00	10 1/4	15	3	G	RH		
	663-45978-00-98	10 1/4	16	3	G	RH		
	688-45932-60-00	13 1/2	14	3	K	RH		
F70A / F80A / F80B / F100A / F100D / F100F / F115A / F115B	688-45978-60-00	13 1/2	16	3	K	RH		
	688-45930-02-00	13	17	3	K	RH		
60F / 70B / 75A / 75C / PRO75 / 80A / 85A / 90A / 100A / PROV100 / 115A / 115B / 115C / 130A / 130B / 140A / 140B / 140C	688-45970-03-00	13	19	3	K	RH		
	688-45972-02-00	13	21	3	K	RH		
	688-45974-02-00	13	23	3	K	RH		
	688-45976-01-98	13	25	3	K	RH		
FL115A / FL115B	6L6-45930-01-00	13	17	3	KL	LH		
L130A / L130B / L140B / L140C	6L6-45970-00-00	13	19	3	KL	LH		
	6L6-45972-00-00	13	21	3	KL	LH		
	6G5-45932-00-00	15 3/4	13	3	M	RH		
F150A / F150D / F200A / F200C / F225A / F225B / F250A / F250B	6G5-45970-02-00	15 1/4	15	3	M	RH		
	6G5-45978-03-00	13 3/4	17	3	M	RH		
150A / 150C / 150F / Z150P / 175A / 175B / 175D / Z175G / 200A / 200B / 200F / Z200N / 220A / 225A / 225B / 225D / 250A / 250B / 250G / Z250D	6G5-45974-03-00	13 3/4	19	3	M	RH		
	6G5-45972-02-00	13 3/4	21	3	M	RH		
	6G5-45976-01-00	13 3/8	23	3	M	RH		
	6G5-45930-00-00	13 3/8	25	3	M	RH		
FL150A / FL150D / FL200A / FL200C / FL225A / FL225B / FL250A / FL250B	6K1-45970-01-00	15 1/4	15	3	ML	LH		
	6K1-45978-02-00	13 3/4	17	3	ML	LH		
L150A / L150C / L150F / LZ150P / L200A / L200B / L200F / LZ200N / L250A / L250B / L250G / LZ250D	6K1-45974-02-00	13 3/4	19	3	ML	LH		
	6K1-45972-01-00	13 3/4	21	3	ML	LH		
	6K1-45976-00-00	13 3/8	23	3	ML	LH		

RELIANCE SERIES - SDS

Outboard Model	Part Number	Diameter	Pitch	Blade	Hub	Rotation	Price	Remark
	68F-45932-10-00	14 1/2	13	3	M	RH		
	68F-45930-10-00	14 1/2	14	3	M	RH		
F150A / F150D / F175A / F200A / F200C / F200F / F200G / F225A / F225B / F225C / F225F / F250A / F250B / F250D / F300B	68F-45970-10-00	14 1/2	15	3	M	RH		
	68F-45972-10-00	14 1/4	17	3	M	RH		
	68F-45978-10-00	14 1/4	18	3	M	RH		
	68F-45974-10-00	13 3/4	19	3	M	RH		SDS spacer (6CE-45997-00-00) required for 68F/68G SDS propellers.
	68F-45976-10-00	13 3/4	21	3	M	RH		
	68G-45930-10-00	14 1/2	14	3	ML	LH		
FL150A / FL150D / FL200A / FL200C / FL200F / FL200G / FL225A / FL225B / FL225F / FL250A / FL250B / FL250D / FL300B	68G-45970-10-00	14 1/2	15	3	ML	LH		
	68G-45972-10-00	14 1/4	17	3	ML	LH		
	68G-45978-10-00	14 1/4	18	3	ML	LH		
	68G-45974-10-00	13 3/4	19	3	ML	LH		
	68G-45976-10-00	13 3/4	21	3	ML	LH		

RELIANCE SERIES - SDS - GENERATION 2

Outboard Model	Part Number	Diameter	Pitch	Blade	Hub	Rotation	Price	Remark
	68F-45932-20-00	14 1/2	13	3	M	RH		
	68F-45930-20-00	14 1/2	14	3	M	RH		
F150A / F150D / F175A / F200A / F200C / F200F / F200G / F225A / F225B / F225C / F225F / F250A / F250B / F250D / F300B	68F-45970-20-00	14 1/2	15	3	M	RH		
	68F-45972-20-00	14 1/4	17	3	M	RH		
	68F-45978-20-00	14 1/4	18	3	M	RH		
	68F-45974-20-00	13 3/4	19	3	M	RH		SDS spacer (688-45997-01-00) required for 68F/68G SDS propellers.
	68F-45976-20-00	13 3/4	21	3	M	RH		
	68G-45930-20-00	14 1/2	14	3	ML	LH		
FL150A / FL150D / FL200A / FL200C / FL200F / FL200G / FL225A / FL225B / FL225F / FL250A / FL250B / FL250D / FL300B	68G-45970-20-00	14 1/2	15	3	ML	LH		
	68G-45972-20-00	14 1/4	17	3	ML	LH		
	68G-45978-20-00	14 1/4	18	3	ML	LH		
	68G-45974-20-00	13 3/4	19	3	ML	LH		
	68G-45976-20-00	13 3/4	21	3	ML	LH		

SALTWATER SERIES II - SDS

Outboard Model	Part Number	Diameter	Pitch	Blade	Hub	Rotation	Price	Remark
F200A / F200C / F225A / F225B / F225C / F225F / F250A / F250B / F250D / F300B	6CE-45930-00-00	15 3/4	13	3	T	RH		
	6CE-45976-00-00	15 3/4	15	3	T	RH		
	6CE-45938-00-00	15 1/2	16	3	T	RH		
	6CE-45978-00-00	15 1/2	17	3	T	RH		
	6CE-45934-00-00	15 1/4	18	3	T	RH		
	6CE-45970-10-00	15 1/4	19	3	T	RH		
	6CE-45932-00-00	15	20	3	T	RH		
	6CE-45972-10-00	15	21	3	T	RH		
	6CE-45936-00-00	14 3/4	22	3	T	RH		
	6CE-45974-00-00	14 3/4	23	3	T	RH		
	6CF-45930-00-00	15 3/4	13	3	TL	LH		
	6CF-45976-00-00	15 3/4	15	3	TL	LH		
	6CF-45978-00-00	15 1/2	17	3	TL	LH		
	6CF-45934-00-00	15 1/4	18	3	TL	LH		
FL200A / FL200C / FL225A / FL225B / FL225F / FL250A / FL250B / FL250D / FL300B	6CF-45970-10-00	15 1/4	19	3	TL	LH		
	6CF-45932-00-00	15	20	3	TL	LH		
	6CF-45972-10-00	15	21	3	TL	LH		
	6CF-45936-00-00	14 3/4	22	3	TL	LH		
	6CF-45974-00-00	14 3/4	23	3	TL	LH		

SALTWATER SERIES II SDS - GENERATION 2

Outboard Model	Part Number	Diameter	Pitch	Blade	Hub	Rotation	Price	Remark
F200A / F200C / F225A / F225B / F225C / F225F / F250A / F250B / F250D / F300B	6CE-45930-20-00	15 3/4	13	3	T	RH		
	6CE-45976-20-00	15 3/4	15	3	T	RH		
	6CE-45938-20-00	15 1/2	16	3	T	RH		
	6CE-45978-20-00	15 1/2	17	3	T	RH		
	6CE-45934-20-00	15 1/4	18	3	T	RH		
	6CE-45970-20-00	15 1/4	19	3	T	RH		
	6CE-45932-20-00	15	20	3	T	RH		
	6CE-45972-20-00	15	21	3	T	RH		
	6CE-45936-20-00	14 3/4	22	3	T	RH		
	6CE-45974-20-00	14 3/4	23	3	T	RH		
	6CF-45930-20-00	15 3/4	13	3	TL	LH		
	6CF-45976-20-00	15 3/4	15	3	TL	LH		
	6CF-45978-20-00	15 1/2	17	3	TL	LH		
	6CF-45934-20-00	15 1/4	18	3	TL	LH		
FL200A / FL200C / FL225A / FL225B / FL225F / FL250A / FL250B / FL250D / FL300B	6CF-45970-20-00	15 1/4	19	3	TL	LH		
	6CF-45932-20-00	15	20	3	TL	LH		
	6CF-45972-20-00	15	21	3	TL	LH		
	6CF-45936-20-00	14 3/4	22	3	TL	LH		
	6CF-45974-20-00	14 3/4	23	3	TL	LH		

SALTWATER SERIES HS4 - SDS

Outboard Model	Part Number	Diameter	Pitch	Blade	Hub	Rotation	Price	Remark
F200A / F200C / F225A / F225B / F225C / F225F / F250A / F250B / F250D / F300B	6CE-45B70-00-00	15	21	4	T	RH		
	6CE-45B72-00-00	15	22	4	T	RH		
	6CE-45B74-00-00	15	23	4	T	RH		
FL200A / FL200C / FL225A / FL225B / FL225F / FL250A / FL250B / FL250D / FL300B	6CF-45B70-00-00	15	21	4	TL	LH		
	6CF-45B72-00-00	15	22	4	TL	LH		
	6CF-45B74-00-00	15	23	4	TL	LH		

SALT WATER SERIES HS4 SDS - GENERATION 2

Outboard Model	Part Number	Diameter	Pitch	Blade	Hub	Rotation	Price	Remark
F200A / F200C / F225A / F225B / F225C / F225F / F250A / F250B / F250D / F300B	6CE-45B70-20-00	15	21	4	T	RH		
	6CE-45B72-20-00	15	22	4	T	RH		
	6CE-45B74-20-00	15	23	4	T	RH		
FL200A / FL200C / FL225A / FL225B / FL225F / FL250A / FL250B / FL250D / FL300B	6CF-45B70-20-00	15	21	4	TL	LH		
	6CF-45B72-20-00	15	22	4	TL	LH		
	6CF-45B74-20-00	15	23	4	TL	LH		

Propellers

SALTWATER SERIES XL - SDS GENERATION 2

Outboard Model	Part Number	Diameter	Pitch	Blade	Hub	Rotation	Price	Remark
F350A (2011--)	6AW-45970-20-00	16 1/4	15	3	X	RH		
	6AW-45972-20-00	16 1/4	17	3	X	RH		
	6AW-45974-20-00	15 1/2	19	3	X	RH		
	6AW-45976-20-00	15 1/4	21	3	X	RH		F350A (until to 2015 MY)
	6AW-45978-20-00	15 1/4	23	3	X	RH		F350A (until to 2015 MY)
FL350A (2011--)	6AX-45970-20-00	16 1/4	15	3	XL	LH		Need Spacer
	6AX-45972-20-00	16 1/4	17	3	XL	LH		6AW-45997-00-00
	6AX-45974-20-00	15 1/2	19	3	XL	LH		
	6AX-45976-20-00	15 1/4	21	3	XL	LH		
	6AX-45978-20-00	15 1/4	23	3	XL	LH		

SALTWATER SERIES XL4 & XL4-HP - SDS GENERATION 2

Outboard Model	Part Number	Diameter	Pitch	Blade	Hub	Rotation	Price	Remark
F350A	6AW-45B70-20-00	16 1/8	15	4	X	RH		
	6AW-45B72-20-00	16 1/8	17	4	X	RH		
	6AW-45B76-20-00	15 3/8	22	4	X	RH		F350A (until to 2015 MY)
	6AW-45B74-20-00	15 3/8	24	4	X	RH		F350A (until to 2015 MY)
FL350A	6AX-45B70-20-00	16 1/8	15	4	XL	LH		Need Spacer
	6AX-45B72-20-00	16 1/8	17	4	XL	LH		6AW-45997-00-00
	6AX-45B76-20-00	15 3/8	22	4	XL	LH		
	6AX-45B74-20-00	15 3/8	24	4	XL	LH		

E-DRIVE PROPELLER

E-Drive Model	Part Number	Diameter	Pitch	Blade	Hub	Rotation	Price	Remark
M15	XEA-45941-00-00	---	---	plastic	---	RH		
M12 / M18 ---2009	MKY-00137-81-21	---	---	plastic	---	RH		
M12 / M18 2010---	MKY-00206-11-22	---	---	plastic	---	RH		
M20 / M26 ---2009	MKY-00137-81-22	---	---	plastic	---	RH		
M20 2010---	MKY-00209-11-60	---	---	plastic	---	RH		
M26 2010---	MKY-00137-81-70	---	---	plastic	---	RH		
M32	MKY-00137-81-29	---	---	plastic	---	RH		

«HYDRA-DRIVE» DIESEL STERN DRIVE BLACK STAINLESS STEEL PROPELLER

Drive Model	Part Number	Diameter	Pitch	Blade	Hub	Rotation	Price	Remark
Single propeller, right-hand rotation	6U3-45971-00-00	18	13	3	WR	RH		
	6U3-45973-00-00	17 1/2	15	3	WR	RH		
	6U3-45975-00-00	17	17	3	WR	RH		
	6U3-45977-00-00	16 3/4	19	3	WR	RH		
	6U3-45979-00-00	16 3/8	21	3	WR	RH		
Single propeller, counter rotation	6U3-45971-10-00	18	13	3	WL	LH		
	6U3-45973-10-00	17 1/2	15	3	WL	LH		
	6U3-45975-10-00	17	17	3	WL	LH		
	6U3-45977-10-00	16 3/4	19	3	WL	LH		
	6U3-45979-10-00	16 3/8	21	3	WL	LH		
TRP (Twin Rotation Propellers) Front	6U4-45942-00-00	15	22	3	(front)	TRP		
	6U4-45946-00-00	15	23	3	(front)	TRP		
	6U4-45951-00-00	15	24	3	(front)	TRP		
	6U4-45955-00-98	15	26	3	(front)	TRP		
	6U4-45959-00-98	15	28	3	(front)	TRP		
TRP (Twin Rotation Propellers) Rear	6U4-45944-00-00	15	22	3	(rear)	TRP		
	6U4-45948-00-00	15	23	3	(rear)	TRP		
	6U4-45953-00-00	15	24	3	(rear)	TRP		
	6U4-45957-00-98	15	26	3	(rear)	TRP		
	6U4-45961-00-98	15	28	3	(rear)	TRP		

PROPELLER SPARE PARTS

Type	Outboard Model	Propeller Mark	Front Spacer	Rear Spacer	Washer	Nut	Cotter pin
Regular Model	F2.5A	BS	6EE-G5987-00-00	N/A (Not Required)	90201-08M54-00	6EE-G5616-00-00	91409-25030-00
	F4B/F5A/F6C	BA	6EE-G5978-00-00				
	F8C/F8F	N	6N0-G5978-10-00				
	F9.9J	N	6G1-45987-02-00	90201-10M01-00	90171-10M01-00	91490-30020-00	
	F15C/F20B	J	6E7-45987-01-00				
	F25D	F	6L2-45987-01-00	689-45997-00-00	92990-14200-00	90171-14013-00	914-90300-30-00
	F30B/F40F	G	663-45987-02	66T-45997-00-00	90389-22M01-00	90171-16011-00	914-90300-30-00
	F50H/F60F	G			90389-22M01		
	F70A	K	688-45987-01-00	67F-45997-00-00	90389-25M00-00	90171-18M04-00	91490-40030-00
	F80B/F100D	K			90389-25M00		
	F(L)115A/F(L)115B/F130A	K, KL					
	F(L)150A/F(L)150D	M, ML	63P-45987-00-00				
	F175A/F(L)200F	M/T, ML/TL		688-45997-01-00	92990-18200-00		
F(L)225F/F(L)250D/F(L)300B (4,2L V6)	T, TL	69J-45987-00-00					
F(L)350A (V8)	X, XL	6AW-45987-00-00	6AW-45997-00	90201-19M01-00			
Dual Thrust Model	FT8D/FT8G	R	6G8-45987-02-00	6G8-45997-00 00	90201-10M02-00	90171-10M07-00	
	FT9.9L	R					914-90300-30-00
	FT25F	G	663-45987-02	68U-45997-00-00	92990-16200-00	90171-16011-00	
FT50J, FT60G	K	688-45987-01-00	67F-45997-00-00	90389-25M00-00			

XTO PROPELLERS

Outboard Model	Part Number	Diameter	Pitch	Blade	Hub	Rotation	Price	Remark
XF425/XF375	6GR-45970-10-00	17 1/8	15	3	Y	RH		
	6GR-45972-10-00	16 7/8	17	3	Y	RH		
	6GR-45974-10-00	16 5/8	19	3	Y	RH		
	6GR-45976-10-00	16 3/8	21	3	Y	RH		
	6GR-45978-10-00	16 1/8	23	3	Y	RH		
	6GR-45930-10-00	16	25	3	Y	RH		
XF425/XF375	6GS-45970-10-00	17 1/8	15	3	YL	LH		
	6GS-45972-10-00	16 7/8	17	3	YL	LH		
	6GS-45974-10-00	16 5/8	19	3	YL	LH		
	6GS-45976-10-00	16 3/8	21	3	YL	LH		
	6GS-45978-10-00	16 1/8	23	3	YL	LH		
	6GS-45930-10-00	16	25	3	YL	LH		

PROPELLER ACCESSORIES



PROP WRENCH

Specially made to fit the prop nut on a Yamaha V4 (2 strokes) or V6 (2-4 strokes) outboard, it also has a helpful 9/16" square opening on the reverse side, designed for opening garboard drain plugs.

MAR-PRPWR-NC-H1

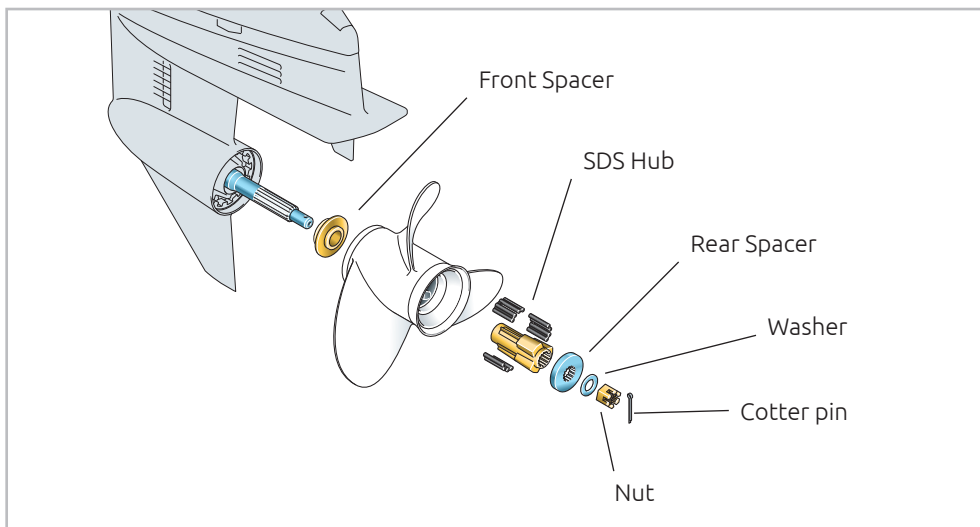

SDS SPACERS

Required for installing an SDS propeller on engines with non-SDS propellers installed - or when the engine in the crate is equipped with a non-SDS spacer.

Part No	Description	QTY	Price
6AW-45997-10-00	For Saltwater XL/XL4 (SDS Gen.1)	1	
6AW-45997-00-00	For Saltwater XL/XL4 (SDS Gen.2 and non-SDS)	1	
6CE-45997-00-00	For F150D/F175A/ F225F/F250D/F300B V6 4.2L, F200F/G SDS GEN 1 SPACER	1	
688-45997-01-00	For F150D/F175A/F200F-G/F225F/F250D/F300B V6 4.2L, (SDS GEN 2 SPACER and NON-SDS)	1	
6GR-45997-00-00	For XTO (425/375)	1	



SDS HUBS

If the damper hub eventually wears on an SDS prop, a replacement hub is available to restore its original shift-dampening efficiency and performance.

Part No	Description	QTY	Price
6AW-45C81-00-00	For F350A V8 SDS propeller (Gen1 from --2014)	1	
6AW-45C81-10-00	For F350A V8 SDS propeller (Gen2 from 2015 --)	1	
6CE-45C81-00-00	For F150D/F175A/F225F/F250D/F300B V6 4.2L, F200F/G, SDS propeller	1	
6EK-45C82-09-00	For TALON aluminium and Stainless Steel propeller	3	
6GR-45C81-10-00	For XTO (425/375)	1	





Latest Helm Master® integrated boat control system now features 3-mode SetPoint™ system and CL7™ display

When you have pioneered the development and production of the most advanced outboard engines in the world - and you offer your customers the widest and most ideal model line-up, with clean, smooth, economical 4-stroke outboard power to suit every possible application, what's the next step? Even greater control over their operation, particularly for multiple installations on larger boats.

With the launch of the very latest Helm Master, Yamaha introduces not only its and unique SetPoint™ system but alongside it, the impressive CL7™ colour display.



THE UNIQUE POWER OF SETPOINT™

The key to SetPoint™ is the inspired concept of linking GPS navigation technology to the well-proven Helm Master system, thus bringing positioning accuracy and boat control to a level never known before and in fact, unparalleled in the leisure marine industry. What is more, this sophisticated system is further refined by the use of a dual-antenna GPS - unique to Yamaha - which delivers more navigational data to the operating system, resulting in even more precise control.

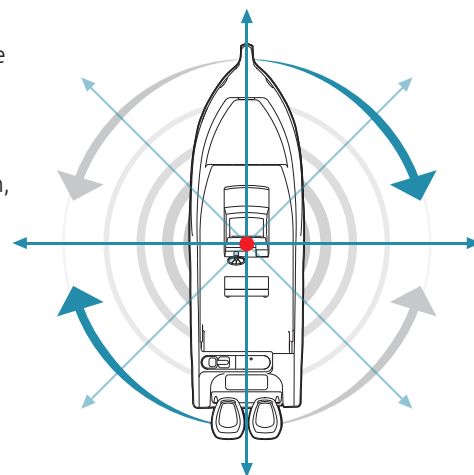

THE THREE SETPOINT MODES: STAYPOINT™ • FISHPOINT™ • DRIFTPOINT™



STAYPOINT HOLDS BOAT NEAR A SELECTED SPOT - MAINTAINING HEADING AND POSITION.
In line for the fuel dock? Or waiting for a bridge to open? This is the job for StayPoint, which uses Helm Master's ability to control thrust and articulation on each engine, independently, to maintain heading and position to within a 75-foot circle of the selected point.



FISHPOINT HOLDS BOAT NEAR A SELECTED SPOT - MAINTAINING POSITION NOT HEADING.
As the name implies, this mode is a great help for fishing - while the Captain's skill and knowledge is needed to keep the bow heading into wind or downwind, FishPoint then maintains boat position, normally only needing to deploy idle RPM to do so. Yamaha's remarkable SDS (Shift Dampener System™) propellers also play a key role in keeping the boat quietly and smoothly in position, so working together, they reduce the chances of scaring away the fish. In stronger winds or currents, this mode will attempt to maintain position using no more than the selected FishPoint RPM (up to 2500).



DRIFTPOINT LETS BOAT DRIFT WITH WIND OR CURRENT - MAINTAINING HEADING NOT POSITION
Ideal for kite or drift fishing, this mode keeps the boat's bow towards the selected compass point, allowing only the wind or current to take effect.

THE HELM MASTER® DEC WITH DRIVE-BY-WIRE JOYSTICK CONTROL

The Helm Master Digital Electronic Control (DEC) with its intuitive joystick, is the gateway to the Drive-by-Wire system - and it's a delight to use, with its mastery of up to 4 outboards - and offers a host of functions, including:

SPEED CONTROL • TRIM ASSIST • SINGLE LEVER • CENTRE ENGINE • FREE THROTTLE • PATTERN SHIFT

The latest DEC Drive-by-Wire controller now has a simple push-button on the top of the joystick to engage and operate the three SetPoint™ modes. Each of the SetPoint functions are user-defined, so boat control is easily customized to each individual owner's needs and preferences. The newest Helm Master® feature allows the operator to troll below standard in-gear trolling speed by shifting into or out of gear to meet a desired target speed. In calm water, resulting minimum speed can be set at less than 0.5 MPH.



Outboard Rigging & Accessories

NOT JUST A JOYSTICK!

Helm Master integrates all these key functions:

- Steering • Throttle • Shifting • Trim • Ignition • Engine & boat data • Security

... AND THERE'S MORE

- Easy-to-read HD 7" touchscreen display • Keyless electronic ignition • Anti-theft system (RFID keyfob) • Speed-sensitive steering friction

STATION SELECTOR

The touch of a button selects 2nd station operation.

SPEED CONTROL

Once the desired rpm is reached, hold it by pressing the Speed Control - then throttle up or down with the touch of a button.

SINGLE LEVER CONTROL

This button synchronises the control of up to three outboards with a single lever.

TRIM ASSIST

Press this button and Helm Master automatically adjusts the engine trim to your preferred setting as you accelerate or decelerate.

FREE THROTTLE

Allows the selected engine to be throttled up when the shift function is disengaged.

CENTRE ENGINE

Press the Center Engine button to run only that engine when trolling - or in no-wake zones. (Triple engine installations only)



TWIN AND TRIPLE SWITCH PANELS

Just one panel controls up to three outboards. Engage all engines with a single key fob and use the 'All Start' button (triple switch panel version only) to start them simultaneously.



KEYLESS START

The swipe of a single, keyless fob engages multiple engines - the ultimate in streamlined convenience. Each Helm Master™ system allows for up to four RFID key fobs



Some restrictions apply. Available on selected twin and triple Yamaha outboard installations and only on new boat packages manufactured by participating boat builders and sold by Authorised Dealers.



360° DIRECTIONAL MOTION AND REAL-TIME RESPONSE

With the central pivot point near the operator and the helm, movement emanates from this location in 360° concentric rings. Place pressure on the joystick in a given direction and the engines respond instantly. A light push or twist of the joystick delivers a slower-paced movement with minimal thrust, while more pressure increases thrust and movement.

MOVING Laterally

Push the joystick to the left or right and your boat will respond effortlessly. This is especially helpful when docking in tight spaces. More force on the joystick will deliver more thrust and directional movement. High and Standard thrust modes allow you to adjust the thrust level quickly - to suit the conditions.

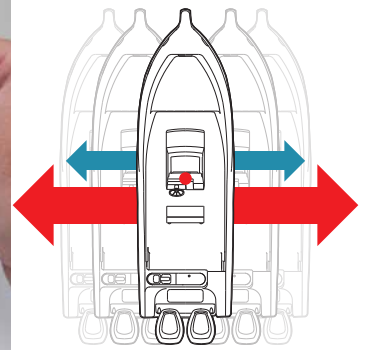

INCLUDING CL7 GAUGE. (SEE INFORMATION ON INSTRUMENTS SECTION)





Instruments

Today's boat owners want more information than ever before - and Yamaha Digital Network Gauges deliver it.

Yamaha is proud to offer a comprehensive line-up of Digital Network Gauges, to bring you more convenience, flexibility, and clear information than you ever thought possible. This really is the leading edge of rigging technology, matched up with the supreme level of innovation and reliability you've come to expect from Yamaha. Experience it.

ALSO NEW IS YAMAHA'S LATEST CL7 DISPLAY, WHICH IS THE POINT-OF-ACCESS FOR SETTING AND CONTROL OF ALL THE SETPOINT FUNCTIONS.

THE CL7 DISPLAY

The CL7 is the primary display unit for the Helm Master system and is also the access point required to configure and operate the new 3-mode SetPoint feature.

Its 7-inch colour display screen offers clear, easy-to-read information even under the most arduous sea conditions - night or day, while the intuitive touch-panel screen has full MFD (Multi-Function Display) capability and connectivity, providing precise engine and boat systems data for up to 4 outboards on one screen.

Other MFD functions, such as maps, fish finder and graphing capabilities are also accessible, thanks to the in-built 10MHz GPS system with its unique dual antenna.



PREMIUM DIGITAL NETWORK GAUGE (6Y9)

Featuring a 5" full-colour, high-resolution LCD display, the 6Y9 Premium Digital Network Gauge II can be configured to display multiple combinations of information based on the operator's preference both for the outboard(s) and the boat status. Available as a convenient Rigging Kit (see page 30)

REGULAR INDICATION:

- Shift position
- Engine speed
- Trim position
- Engine temperature
- Cooling water pressure
- Oil pressure
- Main battery voltage
- Sub-battery voltage
- Boat speed
- Fuel economy
- Fuel consumption
- Fuel flow
- Engine operating hours
- Trip meter
- Available fuel volume
- Connections for up to 4 tanks
- Seawater temperature
- Depth
- Maintenance interval notice
- Trolling speed adjustment (depending on model)



DESCRIPTION	PART NO	PRICE
6Y9 Colour Display	6Y9-83710-13-00	
Replacement Cover	6Y9-87278-00-00	
Replacement Bezel	6Y9-83512-00-00	

ALERT INDICATION:

- Overheat
- Low oil pressure
- Low voltage
- Water in fuel
- Check engine

CONDITION INDICATION:

- Yamaha security system on duty
- Under warming up control
- Under synchronization control

DUAL-PROTOCOL DIGITAL NETWORK GAUGE (6YC)

Full-color 4.3" TFT display with adjustable illumination, low reflection filter and anti-dazzle Night Mode. Dual protocol (6Y8 and 6Y9) capability with easy-operation buttons to select readouts for multiple functions, including warnings, Y-COP activation and boat system control information.

Application: All fuel injection outboard models (F30B and up). Supports single and twin engine applications. (Triple not supported)

INDICATION	UNITS
Engine speed	100 r/min
Trim indication	11 levels (10 segments)
Engine temperature	5 levels
Cooling water pressure	5 levels
Oil pressure	5 levels
Voltage	5 levels or volt
Total operating hour	0-99999 Hr
Trip hour	0.0-999.9 Hr
Immobilizer indicator	Activate/deactivate
Maintenance notification	100 Hrs interval
Illumination control	6 steps
Trolling speed adjustment	50 r/min steps
Boat speed (pitot)*	MPH, km/h or knot
Boat speed (GPS)*	MPH, km/h or knot
2 tank fuel level	11 levels (10 segments)
Fuel flow	GPH, L/h
Fuel Economy	MPG, km/L or nm/L
Fuel consumption	U.S. Gallon or Litter
Depth*	Feet, meter
Sea Temperature*	Fahrenheit or Celsius
Clock*	24 hours
Trip distance*	mile, km or N-mile (0.0-9999)
Diagnosis code	up to 5 codes (each engine)
Alert	Overheat/Low oil press./Water in fuel/Low voltage/Check engine

* Optional function

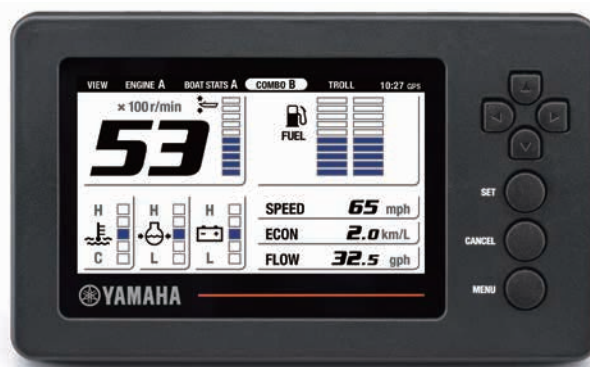

DESCRIPTION	PART NUMBER	PRICE
6YC colour display	6YC-83710-03-00	

DIGITAL NETWORK GAUGES (6Y8 ROUND)

6Y8 Digital Network Gauges are simple, streamlined and sophisticated. The large LCD displays provide easy-to-read information at a glance, allowing you to monitor everything from engine function and fuel management to trim levels, battery voltage, and more. Available as a convenient Rigging Kit (see page 30)

GENERAL FEATURES:

- Each LCD display can show multiple types of information.
- Information is shown in 2 different formats for main (large - on top) and sub-information (small - below).
- Pre-selectable sub-information selection.
- Each LCD display performs a self-function check on start-up.
- Backlighting can be dimmed individually or together (when multiple gauges are installed).

6Y8 TACHOMETER (ROUND)

6Y8-8350T-20-00

- Engine speed • Trim position • Oil pressure • Cooling water pressure (*2)
- Total operating hours • Trip hours • Battery voltage • Engine temperature • Maintenance interval notice • Overheat alert • Low oil pressure alert • Low battery voltage alert • Water in fuel alert • Check Engine alert • Trolling speed adjustment (depends on outboard model) • Diagnosis code



6Y8 SPEED/FUEL COMBINATION METER (ROUND)

6Y8-83500-20-00

- Boat speed (*1) • Trip meter • Clock • Battery voltage • Fuel tank level (up to 2 tanks) • Fuel flow • Fuel consumption • Fuel economy • Seawater temperature (*2) • Seawater depth (*2)



(*1) GPS connection required (NMEA 0813)

(*2) Optional sensor required (see page 47)

OPTIONAL ROUND DASHBOARD

Description	Part Number	Price
DASHBOARD ROUND (2 HOLES)	YMM09D010000	
GAUGE PLATE RINGS (2 PCS)	YMM09PR10000	

Outboard Rigging & Accessories

ANALOG GAUGES

Premium quality analog instruments made to work in perfect harmony with your Yamaha outboard.

	Description	Remarks	Price
1	Speedometer Kit/Speedometer assy	Speed. Trip. Time. Fuel. Battery voltage.	
2	Tachometer kit/Tachometer assy	Engine RPM. Trim angle. Oil level. Hour meter. Water separator warning indicator. Warning lamps. Engine warning indicator. Overheat warning lamp.	
3	Water pressure meter kit	Fuel consumption. Fuel economy. Fuel contamination.	
4	Water temp. meter kit		
5	Fuel meter assy		
6	Fuel meter assy		
7	Voltmeter assy		
8	Trim Gauge		
9	Digital speedometer assy		
10	Digital tachometer assy		
11	Digital fuel meter kit Single		
12/22	Speedometer assy		
13/23	Tachometer assy		
14/24	Water pressure meter assy		
15/25	Water temp. assy		
16/26	Hour meter assy		
17/27	Fuel meter assy		
18/28	Trim meter assy		
19/29	Voltmeter assy		

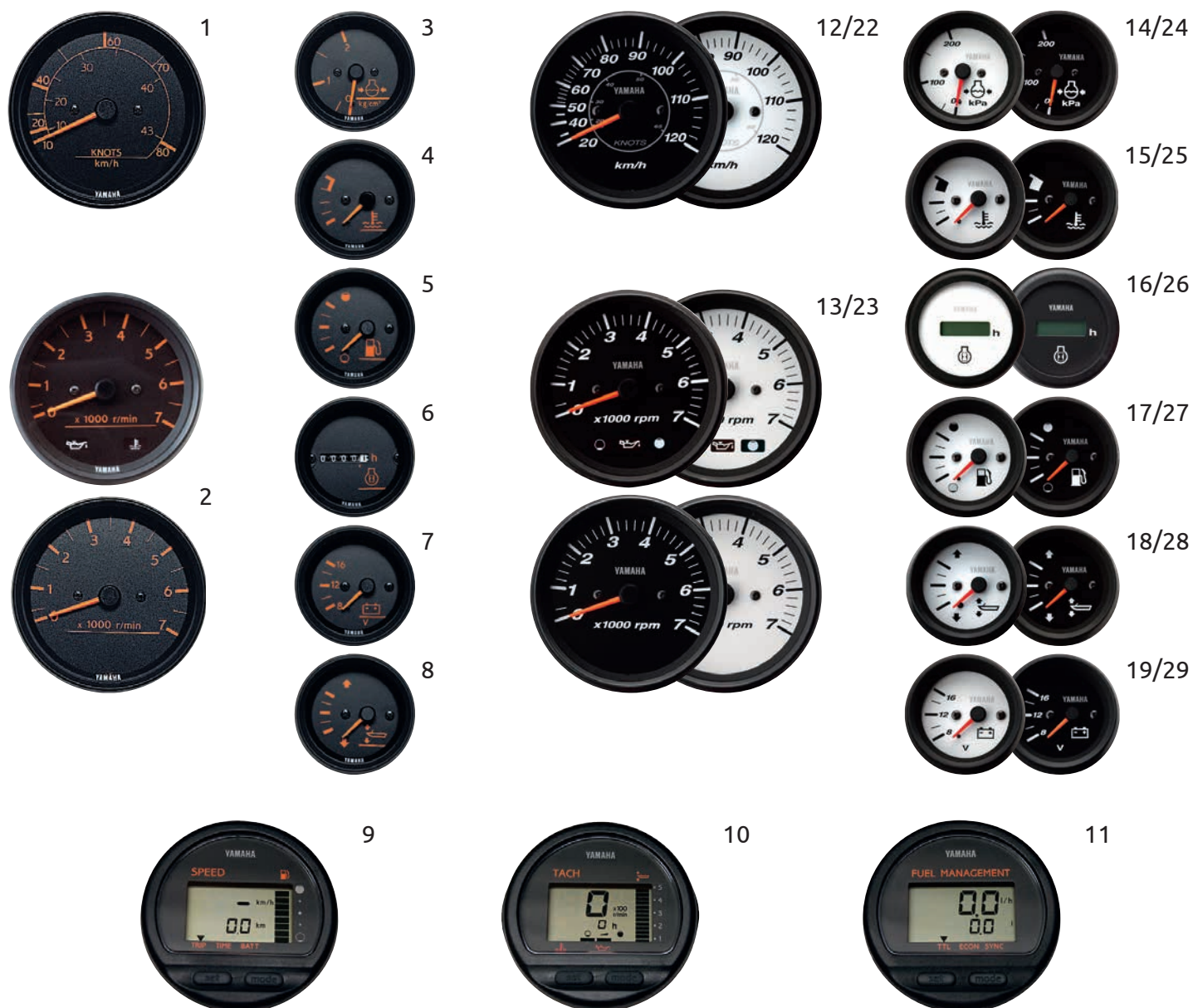

DESCRIPTION	PART NUMBER	COLOUR	DIAM (mm)	6C/D 8C 9,9D/F 15D/F 20C/D 30A/G	30D	40H 50D	40V 50H	40X 55BE	PRO50 50G	60F 70B	75C PRO75 80A 90A	75A 85	All 2 strokes V4/V6	F6A/B F8C FT8D F9,9C FT9,9D F15A	F20A F25A F25B	F30A F40A/B/C F45A F50A/F FT50B/C/G F60A FT60B/D F80A/B F100A/D F150A F115A F30A F225A F250A	REMARKS
1 Speedometer Kit	6Y5W00814000	Black	85	•				•	•			•		•	•		Max 80km/h - 43knots - With sender
Speedometer assy	6Y5835103000	Black	85		•	•	•			•						•	Max 80km/h - 43knots - Without sender
Speedometer Kit	6Y5W00812000	Black	85								•	•	•			•	Max 120km/h - 65knots - Without sender
2 Tachometer kit	6Y5W00800200	Black	85				•		•	•			•				With oil lamp - OM until 1993
Tachometer assy	6Y5835400500	Black	85				•		•	•			•				With oil lamp - OM from 1994 and later
Tachometer kit	6Y5W00801200	Black	85	•	•	•		•				•		•			Without lamp - With harness 6Y5835530000
Tachometer assy	6Y5835402000	Black	85												•	•	With oil lamp & water temp. (4stroke)
* Wire Lead	6Y5835530000	Black			•	•	•	•	•	•	•	•	•	•	•	•	Electric Start engine
3 Water pressure meter kit	6Y5W00880000	Black	52			•	•	•	•	•	•	•	•	•	•	•	With sender
4 Water temp. meter kit	6Y5W00881000	Black	52			•	•	•	•	•	•	•	•	•	•	•	With sender
5 Fuel meter assy	6Y5857501000	Black	52	•	•	•	•	•	•	•	•	•	•	•	•	•	For 33-240 ohm sender
6 Hour meter assy	6Y5835040100	Black	52	•	•	•	•	•	•	•	•	•	•	•	•	•	Mechanical Start engine
7 Voltmeter assy	6Y5835030000	Black	52	•	•	•	•	•	•	•	•	•	•	•	•	•	
8 Trim Gauge	6Y5836700100	Black	52			•	•	•	•	•	•	•	•	•	•	•	OM until 1991 (short shaft)
Trim Gauge	6Y5836701000	Black	52			•	•	•	•	•	•	•	•	•	•	•	OM from 1990 to 1993 (long shaft)
Trim Gauge	6Y5836701100	Black	52			•	•	•	•	•	•	•	•	•	•	•	OM from 1994 to 2000
Trim meter assy	6Y5836701200	Black	52			•	•	•	•	•	•	•	•	•	•	•	Om from 2001 and later
9 Digital speedometer assy	6Y5835005600	Black	85			•	•		•	•			•			•	OM from 1994 and later Without pipe
* Tube	6Y5835571000	Black															Speedo tube. 8m
10 Digital tachometer assy	6Y58350T0400	Black	85				•		•	•	•		•			•	OM from 1994 and later (trim, Hour meter)
11 Digital fuel meter kit Single	6Y5W00885400	Black	85			•	•	•	•	•	•	•	•	•	•	•	Single engine (harness, 1 fuel economy sensor)
Digital fuel meter kit Twin	6Y5W00886500	Black	85			•	•	•	•	•	•	•	•	•	•	•	Twin engines (harness, 2 fuel economy sensor)
* Cord assy 1	6Y5871225000	Black															Optional
* Wire Lead	6Y585721F000	Black															Optional
12 Speedometer assy	6Y7835106000	Black	85	•	•	•	•	•	•	•	•	•	•	•	•	•	Max 80km/h - 43knots - Without sender
Speedometer assy	6Y7835104000	Black	85								•	•	•			•	Max 120km/h - 65knots - Without sender
13 Tachometer assy	6Y7835400000	Black	85				•		•	•			•				With oil lamp - OM from 1994 and later
Tachometer assy	6Y7835402000	Black	85	•	•	•		•						•			Without lamp
Tachometer assy	6Y7835404000	Black	85												•	•	With oil lamp, water temp. (4 stroke)
14 Water pressure meter assy	6Y7836600000	Black	52			•	•	•	•	•	•	•	•	•	•	•	Without sender
* Sender	688836670000	Black															With 10m tube
15 Water temp. assy	6Y7835900000	Black	52			•	•	•	•	•	•	•	•	•	•	•	Without sender
* Thermo unit	688835910000	Black															With 7m harness
16 Hour meter assy	6Y7835040000	Black	52	•	•	•	•	•	•	•	•	•	•	•	•	•	Digital
17 Fuel meter assy	6Y7857501000	Black	52	•	•	•	•	•	•	•	•	•	•	•	•	•	For 33-240 ohm sender
18 Trim meter assy	6Y7836700000	Black	52			•	•	•	•	•	•	•	•	•	•	•	Om from 2001 and later
19 Voltmeter assy	6Y7835030000	Black	52	•	•	•	•	•	•	•	•	•	•	•	•	•	
20 Hour meter	ENGINE-TER4C0100	Black													•	•	2 stroke - 4 stroke
Hour & Tacho meter	ENGINE-TER4C0200	Black													•	•	4 stroke
22 Speedometer assy	6Y7835107000	White	85	•	•	•	•	•	•	•	•	•	•	•	•	•	Max 80km/h - 43knots - Without sender
Speedometer assy	6Y7835105000	White	85								•	•	•			•	Max 120km/h - 65knots - Without sender
23 Tachometer assy	6Y7835401000	White	85				•		•	•			•				With oil lamp - OM from 1994 and later
Tachometer assy	6Y7835403000	White	85	•	•	•		•						•			Without lamp
Tachometer assy	6Y7835405000	White	85												•	•	With oil lamp & water temp. (4stroke)
24 Water pressure meter assy	6Y7836602000	White	52			•	•	•	•	•	•	•	•	•	•	•	Without sender
* Sender	688836670000	White															With 10m tube
25 Water temperature assy	6Y7835901000	White	52			•	•	•	•	•	•	•	•	•	•	•	Without sender
* Thermo unit	688835910000	White															With 7m harness
26 Hour meter assy	6Y7835041000	White	52														Digital
27 Fuel meter assy	6Y7857503000	White	52	•	•	•	•	•	•	•	•	•	•	•	•	•	For 33-240 ohm sender
28 Trim meter assy	6Y7836702000	White	52			•	•	•	•	•	•	•	•	•	•	•	Om from 2001 and later
29 Voltmeter assy	6Y7835031000	White	52	•	•	•	•	•	•	•	•	•	•	•	•	•	

It is possible to install these analog instruments on all V6 - 4.2l F(L)225F/F(L)250D/F(L)300B and V8 F(L)350A (from 2011 onwards) with AGI interface: 6Y98A2D03000 (page 47)

Remote Controls



Yamaha Remote Controls set the standard for operator comfort, convenience and flexibility. Their intuitive ergonomic designs allow for virtually effortless, one-hand control of throttle and shift functions, and allow for surprisingly easy command of horsepower and multiple engine installations.

REMOTE CONTROL TYPE	MODEL	MOUNTING POSITION		NUMBER OF ENGINES			
				Single	Twin	Triple	
DIGITAL (DRIVE-BY-WIRE) (F200G - F350A)	6X6	Top Mount		X	X	X	 Side Mount
	6X7	Flush Mount		X			
	703	Side Mount		X			 Flush Mount
MECHANICAL (F8 - F200F)	704	Top Mount		X	X		 Side Mount
	6X3	Flush Mount		X			

DIGITAL DRIVE-BY-WIRE (DBW) REMOTE CONTROLS

The operation of throttle and shift is controlled electronically by the Digital Network System, providing you with smoother remote control - and with no cable friction! Multiple engine remote controls feature automatic engine RPM synchronization. Thanks to the convenience of our "plug and play" systems, rigging work is now simplicity itself - even 2nd station installation is a breeze.

DBW REMOTE CONTROL BOX FOR SINGLE STATION

#	Part Number	Variation Code	Engine	Mount	Price	Single Station	Dual Station		Remarks
							Main Station	2nd Station	
1	6X6-48205-61-00	A	Single			1			Single station only
2	6X6-48207-61-00	B	Twin	Top mount		1			(no extension for dual-station)
3	6X6-48208-61-00	F	Triple			1	1		
4	6X7-48206-21-00	A	Single	Flush mount		1			With emergency shut-off cord.

For quad engine installation contact your dealer.

CONTROLS

An exclusive suite of binnacle style drive-by-wire remote control boxes. Available in single, twin or triple engine versions and fully compatible with Yamaha's Digital Network Systems.

1 - 6X6 SINGLE ENGINE TOP MOUNT



2 - 6X6 TWIN ENGINE TOP MOUNT



3 - 6X6 TRIPLE ENGINE TOP MOUNT



6Y8 (Round) / 6YC / 6Y9 / CL7

GAUGE



ENGINE



SWITCH



6X6 CONTROL SPACER KITS

Description	Part Number	Price
6X6 Single Control Box Spacer	MARSHIM86500	
6X6 Twin Control Box Spacer	MARSHIM86600	

4 - 6X7 SINGLE ENGINE FLUSH MOUNT

A compact, flush side-mounted digital drive-by-wire remote control box with an integrated lanyard switch. Key switch panel and main wire harness supplied separately.



6Y8 (Round) / 6YC / 6Y9 / CL7

GAUGE



ENGINE



SWITCH



DBW REMOTE CONTROL BOX FOR DUAL STATIONS

#	Part Number	Variation Code	Engine	Mount	Price	Single Station	Dual Station		Remarks	
							Main Station	2nd Station		
1a	6X6-48205-71-00	C	Single	Top mount		1	1		For main station	
1b	6X6-48205-81-00	G							1	For 2nd station
2a	6X6-48207-71-00	D	Twin			1	1			For main station
2b	6X6-48207-81-00	H							1	For 2nd station
3a	6X6-48208-61-00	F	Triple			1	1			For main station
3b	6X6-48208-71-00	K							1	For 2nd station
4a	6X7-48206-31-00	C	Single	Flush mount			1		For main station	
4b	6X7-48206-41-00	G	Single	Flush mount				1	For 2nd station	

Outboard Rigging & Accessories

MECHANICAL REMOTE CONTROLS

Operated by mechanical cable to control throttle and shift mechanism.

1 - 703 SINGLE ENGINE SIDE MOUNT

Designed with broad compatibility in mind, this remote control can be fitted to almost every boat type and is compatible with almost every engine in the Yamaha Outboard range. The 703 delivers all of the basic control functions and open throttle can also be configured in either the push or pull direction.



GAUGE	6Y8 (Round) / 6YC / CL7*		

ENGINE	
--------	--

SWITCH	-
--------	---

2 - 6X3 SINGLE ENGINE FLUSH MOUNT

A right-side flush mounted mechanical remote control with integrated lanyard switch. Push action to open throttle. Single key switch panel (without lanyard switch) and 10-pin wire harness supplied separately.



GAUGE	6Y8 (Round) / 6YC / CL7*		

ENGINE	
--------	--

SWITCH	
--------	--

3 - 704 TOP MOUNT SINGLE

Designed for use with electric start models and ideally fitted to center console boats. Available in single and twin lever configurations for single and twin engine installations. A switch panel and extension wire harness are required to connect to the engine 10-pin harness.



GAUGE	6Y8 (Round) / 6YC / CL7*		

ENGINE		
--------	--	--

SWITCH		
--------	--	--

4 - 704 TOP MOUNT TWIN



SWITCH		
--------	--	--

* EFI outboard models only

MECHANICAL REMOTE CONTROL BOXES

#	Part Number	Engine	Throttle		PTT	Mount	Price	Remarks
			Push	Pull				
1a	703-48207-22-00	Single	1		1	Side mount		For Electric start models.
1	703-48260-20-00			1				For Manual start models.
	703-48206-20-00			1		(replacement of 701 control)		
2	6X3-48206-10-00		1		1	Starboard mount		REMOTE CTRL 6X3 FM (run about)
2b	6X3-48206-21-00					Port mount		REMOTE CTRL 6X3 FM (center console)
3	704-48205-R0-00	Twin	1		1	Top Mount		
4	704-48207-R0-00			1				1

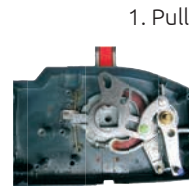

703-48861-11-00

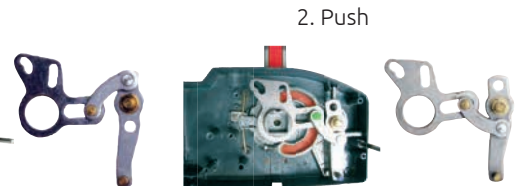

703-48261-01-00

704 CONTROL SPACER KITS

Description	Part Number	Price
For 704 Premium Single	704-48293-20-00	
For 704 Premium Twin	704-48293-30-00	

703 THROTTLE CONVERSION

Description	Part Number	Price
1 703 Conversion Kit (Pull to Push)	703-48261-01-00	
2 703 Conversion Kit (Push to Pull)	703-48261-11-00	



Outboard Rigging & Accessories

REMOTE CONTROL - REMOTE CONTROL ATTACHMENT KITS

The best way to convert your Yamaha outboard throttle and shift cable from manual to remote operation with the least amount of fuss.

- Solid & durable corrosion-resistant construction
- For use with remote controls and control cables
- Steering hook not included

We strongly recommend that all cable specification and installation work be carried out by an Authorised Yamaha Dealer, where further product details and helpful advice are always available.

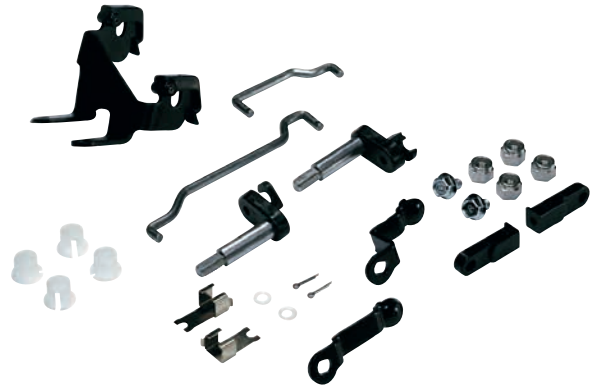

ENGINE	PART NUMBER	PRICE
9.5A/12A/15A	YMM-21201-00-00	
4A/5C	YMM-21202-00-00	
6B/8B	655-48501-02-00	
6C/D/8C	YMM-21204-00-00	
F6A/F6B/F8C/FT8D	6DR-48501-00-00	
9.9D/15D	YMM-21205-00-00	
9.9F/15F	YMM-21206-00-00	
F15C/F20B	6AH-48501-00-00	
F8A/B/F9.9A/B/FT9.9A	6G8-48501-03-00	
F9.9C/FT9.9D/F15A	66M-48501-00-00	
F9.9F/F9.9J	6DR-48501-00-00	
FT9.9G/FT9.9L	6DR-48501-00-00	

ENGINE	PART NUMBER	PRICE
F25A/F20A/ FT25B	65W-48501-00-00	
F25D	6BL-48501-00-00	
F25G	6FM-48501-00-00	
20C/D/V/30A/G/25D	YMM-21207-00-00	
20D/25N ('90--)	6L2-48501-11-00	
30D (--'93)	6J8-48501-02-EJ	
25J/30D ('94--)	6J8-48501-03-4D	
40Q	6R6-48501-00-00	
40X	66T-48501-01-00	

CONNECTORS FOR ATTACHMENT KITS

Connector to motor	YMM-21220-00-00
Gas connector for YMM-21205-00	YMM-21230-00-00
Gas connector for YMM-21201-00, YMM-21202-00, YMM-21204-00, YMM-21206-00 and YMM-21207-00	YMM-21232-00-00
Shift connector for YMM-21205-00	YMM-21231-00-00
Shift connector for YMM-21201-00, YMM-21202-00, YMM-21204-00, YMM-21206-00 and YMM-21207-00	YMM-21233-00-00

ULTRAFLEX AND TELEFLEX CONTROLS

Model	Description	Part Number	Price
Ultraflex B183	Flush Side Mount	YMM-21110-00-00	
Ultraflex B85	Flush Side Mount	YMM-21111-00-00	
Ultraflex B89	Side Mount White (6C-50H)	YMM-21100-00-00	
Ultraflex B90	Side Mount Black (6C-50H)	YMM-21100-10-00	
Teleflex Side Mount	(6C-50H)	YMDRCBOX-00-00	



Ultraflex B183



Ultraflex B85



Ultraflex B89



Ultraflex B90



Teleflex Side Mount

REMOTE CONTROL CABLES

Only the very best cable performs smoothly and reliably enough to be a match for the renowned quality of a Yamaha Remote Control.

Premium PowerMatched control cable (YPM)



- Stainless Steel Rod
- Wiper seal
- 16" max swivel
- Nickel-plated brass sleeve
- Swivel seat
- Rotary swaged stainless steel hub
- Ultraviolet-stabilised high-density polyethylene outer jacket
- Long-lay oil-tempered wires
- High-density polyethylene liner
- Nylon-covered stranded core wire

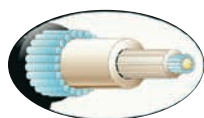

Splines reduce contact area with liner for ultra low friction

STANDARD CABLE (Y32)

Yamaha offers you a choice of remote control cables that are a perfect match for our controls. These well proven original cables have set the standard with advanced technology that reduces friction and delivers excellent performance. The standard-core wires increase strength and reduce binding, allowing for a 4-inch bend radius.

MID-RANGE CABLE (C8)

This mid-range cable offers great efficiency, thanks to high level of flexibility for a reduced cable bend radius. Featuring stainless steel cables and fittings as well as a very high resistance blue outer jacket for protection against abrasion, UV and chemicals.

PREMIUM POWERMATCHED CONTROL CABLE (YPM)

These are top-of-the-line cables, with features and performance that have made them the first choice of professional riggers. The ultra-low-friction inner core wire has splines and a special cover to reduce contact with the liner, allowing rigging to even tighter tolerances; another benefit is reduced 'play' at the cable ends. We strongly recommend the use of Premium PowerMatched cables for boats with severe applications and long cable lengths, on twin-engine installations - and in fact, on any boat where unrivalled smoothness is required. These cables are designed to run smoothly even if installation demands that curves or a radius be applied within the cable run.

FEET	CM	STANDARD (Y32)	PRICE	MID-RANGE (C8)	PRICE	PREMIUM (YPM)	PRICE
5'	152	YMM-21005-00-00		-		-	
6'	183	YMM-21006-00-00		YMM-21006-C8-00		YMM-21006-PM-30	
7'	213	YMM-21007-00-00		YMM-21007-C8-00		YMM-21007-PM-30	
8'	244	YMM-21008-00-00		YMM-21008-C8-00		YMM-21008-PM-30	
9'	274	YMM-21009-00-00		YMM-21009-C8-00		YMM-21009-PM-30	
10'	305	YMM-21010-00-00		YMM-21010-C8-00		YMM-21010-PM-30	
11'	335	YMM-21011-00-00		YMM-21011-C8-00		YMM-21011-PM-30	
12'	366	YMM-21012-00-00		YMM-21012-C8-00		YMM-21012-PM-30	
13'	396	YMM-21013-00-00		YMM-21013-C8-00		YMM-21013-PM-30	
14'	427	YMM-21014-00-00		YMM-21014-C8-00		YMM-21014-PM-30	
15'	457	YMM-21015-00-00		YMM-21015-C8-00		YMM-21015-PM-30	
16'	488	YMM-21016-00-00		YMM-21016-C8-00		YMM-21016-PM-30	
17'	518	YMM-21017-00-00		YMM-21017-C8-00		YMM-21017-PM-30	
18'	549	YMM-21018-00-00		YMM-21018-C8-00		YMM-21018-PM-30	
19'	579	YMM-21019-00-00		YMM-21019-C8-00		YMM-21019-PM-30	
20'	610	YMM-21020-00-00		YMM-21020-C8-00		YMM-21020-PM-30	
21'	640	YMM-21021-00-00		YMM-21021-C8-00		YMM-21021-PM-30	
22'	671	YMM-21022-00-00		YMM-21022-C8-00		YMM-21022-PM-30	
23'	701	YMM-21023-00-00		YMM-21023-C8-00		YMM-21023-PM-30	
24'	732	YMM-21024-00-00		YMM-21024-C8-00		YMM-21024-PM-30	
25'	762	YMM-21025-00-00		YMM-21025-C8-00		YMM-21025-PM-30	
26'	792	YMM-21026-00-00		YMM-21026-C8-00		YMM-21026-PM-30	
27'	823	YMM-21027-00-00		YMM-21027-C8-00		YMM-21027-PM-30	
28'	853	-		YMM-21028-C8-00		YMM-21028-PM-30	
29'	884	-		YMM-21029-C8-00		YMM-21029-PM-30	
30'	914	YMM-21030-00-00		YMM-21030-C8-00		YMM-21030-PM-30	

Yamaha recommends YPM cables. If not applicable for rigging certain types of boats, C8 or Y32 cables may be used.

Outboard Rigging & Accessories

SWITCH PANELS - FOR DRIVE-BY-WIRE (DBW)



1 - SINGLE ENGINE KEY SWITCH WITH LANYARD

2 - TWIN/TRIPLE ENGINE KEY SWITCH WITH LANYARD



3 - TWIN ENGINE START/STOP SWITCH

4 - TRIPLE ENGINE START/STOP SWITCH



5 - ALL START/STOP SWITCH

6 - DUAL STATION SELECTOR



7 - DUAL STATION SINGLE ENGINE START/STOP SWITCH

8 - DUAL STATION LANYARD SWITCH



SWITCHES FOR SINGLE STATION

#	Part Number	Description	Engine			Single Station	Dual Station		Price
			Single	Twin	Triple		Main Station	2nd Station	
1	6X6-82570-33-00	Single engine key switch with lanyard	1			1	1		
2	6X6-82570-40-00	Twin engine key switch with lanyard		1		1	1		
	6X6-82570-50-00	Triple engine key switch with lanyard			1	1	1		
3	6X6-82570-60-00	Twin engine Start/Stop switch - Main Station		1		1	1		
4	6X6-82570-70-00	Triple Engine Start/Stop switch - Main Station			1	1	1		
5	6X6-82570-D0-00	All Start/Stop switch		1	1	1	1		

SWITCHES FOR DUAL STATIONS

#	Part Number	Description	Engine			Single Station	Dual Station		Price
			Single	Twin	Triple		Main Station	2nd Station	
3	6X6-82570-E0-00	Twin engine Start/Stop switch - 2nd Station		1				1	
4	6X6-82570-F0-00	Triple engine Start/Stop switch - 2nd Station			1			1	
6	6X6-82570-B0-00	Station selector - Dual Station	1	1	1		1	1	
7	6X6-82570-80-00	Single engine Start/Stop switch - 2nd Station	1					1	
8	6X6-82570-90-00	Lanyard switch - 2nd Station	1	1	1			1	

TWIN AND TRIPLE INSTALLATION KITS - FOR CL7

#	Part Number	Description	Engine			Single Station	Dual Station		Price
			Single	Twin	Triple		Main Station	2nd Station	
6X6-762B0-00-00 Main Helm Switch Panel twin kit contains:									
2	6X6-82570-40-00	Twin engine key switch with lanyard		1		1	1		
3	6X6-82570-60-00	Twin engine Start/Stop switch - Main Station		1		1	1		
6X6-762B0-10-00 Main Helm Switch Panel triple kit contains:									
2	6X6-82570-50-00	Triple Engine key switch lanyard			1	1	1		
4	6X6-82570-70-00	Triple Engine Start/Stop switch - Main Station			1	1	1		

SWITCH PANELS - FOR MECHANICAL REMOTE CONTROL



1 - SINGLE ENGINE KEY SWITCH WITH LANYARD

2 - SINGLE ENGINE MAIN STATION SWITCH WITH PANEL



3 - TWIN ENGINE KEY SWITCH WITH LANYARD



4 - REPLACEMENT LANYARD CORD



#	P/N	Description	Remote control	Remark	Price
1	704-82570-12-00	Single key switch with lanyard	For 704 single	With choke switch	
2	64D-82570-22-00	Single engine Main Station switch with panel	For 6X3/6X7	w/ 2P coupler for Emergency Stop SW	
3	6Y8-82570-04-00	Twin key switch with lanyard	For 704 twin	For Digital network system (6Y8)	
4	682-82556-00-00	Engine shut-off lanyard cord	---	Replacement lanyard cord	





Rigging Kits

What exactly do you need for your boat and engine?

Even though Yamaha's Digital Network rigging components are sophisticated, powerful and very advanced, they are made to be simple to understand and to use. We know too, that choosing exactly the right rigging components to fit your boat can still be a hassle ... but don't worry! A Yamaha Rigging Kit will make your choice a breeze - and ordering couldn't be simpler.

RIGGING KITS - FOR DBW REMOTE CONTROL

6Y9 SINGLE RIGGING KIT (WITHOUT SWITCH PANEL) 6Y9-W0035-27-00

Parts Number	Description	Qty
6Y9-83710-13-00	MULTI-FUNCTION COLOUR DISPLAY (6Y9)	1
6Y8-81920-01-00	MULTI-HUB ASSY	1
6Y8-82582-11-00	TERMINAL CAP (4 PIN/DEVICE)	2
6Y8-82553-01-00	MAIN BUS HARNESS 6 PIN (0.3 M / 1 FT)	1
6Y8-82521-31-00	PIGTAIL BUS HARNESS 4 PIN (1.8 M / 6 FT)	1
6Y9-83553-40-00	6Y9 DISPLAY CONVERSION HARNESS	1
6Y9-83553-00-00	DBW MAIN BUS WIRE ADAPTOR HARNESS	1
6Y8-83553-01-00	SYSTEM POWER SUPPLY WIRE (2.4 M / 8 FT)	1
6Y9-8356N-01-00	6Y9 GPS WIRE (NMEA 0183)	1
6Y9-8356N-10-00	6Y9 FUEL WIRE	1
6X6-8258A-30-00	DBW MAIN HARNESS 16 PIN (10 M / 32 FT)	1
6Y9-2819K-E0-00	SET-UP MANUAL	1
6Y9-2819U-72-00	OWNERS MANUAL	1
6Y9-2819U-82-00	OWNERS MANUAL	1

* DBW remote control box and switch panels are required separately.



6Y9 TRIPLE RIGGING KIT 6Y9-762G0-40-00

Parts Number	Description	Qty
6Y9-83710-13-00	MULTI-FUNCTION COLOUR DISPLAY (6Y9)	1
6Y8-81920-01-00	MULTI-HUB ASSY	1
6Y8-82582-11-00	TERMINAL CAP (4 PIN/DEVICE)	2
6Y8-82553-01-00	MAIN BUS HARNESS 6 PIN (0.3 M / 1 FT)	1
6Y8-82521-31-00	PIGTAIL BUS HARNESS 4 PIN (1.8 M / 6 FT)	1
6Y9-83553-40-00	6Y9 DISPLAY CONVERSION HARNESS	1
6Y9-83553-00-00	DBW MAIN BUS WIRE ADAPTOR HARNESS	1
6Y8-83553-01-00	SYSTEM POWER SUPPLY WIRE (2.4 M / 8 FT)	1
6Y9-8356N-01-00	6Y9 GPS WIRE (NMEA 0183)	1
6Y9-8356N-10-00	6Y9 FUEL WIRE	1
6X6-82570-50-00	TRIPLE ENGINE MAIN SWITCH PANEL	1
6X6-82570-70-00	TRIPLE ENGINE START/STOP PANEL	1
6X6-8258A-40-00	DBW MAIN HARNESS 16 PIN (12 M / 38 FT)	3
6Y9-2819K-E0-00	SET-UP MANUAL	1
6Y9-2819U-72-00	OWNERS MANUAL	1
6Y9-2819U-82-00	OWNERS MANUAL	1

* DBW remote control box is required separately.



Outboard Rigging & Accessories

RIGGING KITS - FOR DBW REMOTE CONTROL

6YC SINGLE RIGGING KIT (WITHOUT SWITCH PANEL) 6Y8-762G-21-00

Parts Number	Description	Qty
6YC-83710-03-00	6YC MULTI FUNCTION COLOUR DISPLAY	1
6Y8-81920-01-00	MULTI-HUB ASSY	1
6Y8-82582-11-00	TERMINAL CAP (4 PIN/DEVICE)	1
6Y8-82521-11-00	PIGTAIL BUS HARNESS 4 PIN (0.6 M / 2 FT)	1
6Y8-82521-31-00	PIGTAIL BUS HARNESS 4 PIN (1.8 M / 6 FT)	1
6Y8-8356N-01-00	6Y8 GPS/FUEL WIRE (NMEA 0183)	1
6Y8-83553-01-00	SYSTEM POWER SUPPLY WIRE (2.4 M / 8 FT)	1
6X6-8258A-30-00	DBW MAIN HARNESS 16 PIN (10 M / 32 FT)	1
6YC-2819U-70-00	OWNER'S MANUAL	1
6YC-2819U-80-00	OWNER'S MANUAL	1

* DBW remote control box and switch panels are required separately.



6YC TWIN RIGGING KIT 6Y8-762G0-11-00

Parts Number	Description	Qty
6YC-83710-03-00	6YC MULTI FUNCTION COLOUR DISPLAY	1
6Y8-81920-01-00	MULTI-HUB ASSY	2
6Y8-82553-01-00	MAIN BUS HARNESS 6 PIN (0.3 M / 1 FT)	1
6Y8-82582-11-00	TERMINAL CAP (4 PIN/DEVICE)	3
6Y8-82582-01-00	TERMINAL CAP (2 PIN/POWER)	1
6Y8-82521-11-00	PIGTAIL BUS HARNESS 4 PIN (0.6 M / 2 FT)	1
6Y8-82521-31-00	PIGTAIL BUS HARNESS 4 PIN (1.8 M / 6 FT)	2
6Y8-8356N-01-00	6Y8 GPS/FUEL WIRE (NMEA 0183)	1
6Y8-83553-01-00	SYSTEM POWER SUPPLY WIRE (2.4 M / 8 FT)	1
6X6-82570-40-00	TWIN ENGINE MAIN SWITCH PANEL	1
6X6-82570-60-00	TWIN ENGINE START/STOP PANEL	1
6X6-8258A-40-00	DBW MAIN HARNESS 16 PIN (12 M / 38 FT)	2
6YC-2819U-70-00	OWNER'S MANUAL	1
6YC-2819U-80-00	OWNER'S MANUAL	1

* DBW remote control box is required separately.



DBW SINGLE ENGINE SECOND STATION SWITCH KIT 6X6-W0035-70-00

Parts Number	Description	Qty
6X6-82570-B0-00	STATION SELECTOR	2
6X6-82570-80-00	SINGLE ENGINE START/STOP SWITCH	1
6X6-82570-90-00	LANYARD SWITCH	1

* For dual station installation



DBW TWIN ENGINES SECOND STATION SWITCH KIT 6X6-762B0-30-00

Parts Number	Description	Qty
6X6-82570-B0-00	STATION SELECTOR	2
6X6-82570-E0-00	TWIN ENGINES START/STOP SWITCH	1
6X6-82570-90-00	LANYARD SWITCH	1

* For dual station installation



DBW TRIPLE ENGINES SECOND STATION SWITCH KIT 6X6-762B0-40-00

Parts Number	Description	Qty
6X6-82570-B0-00	STATION SELECTOR	2
6X6-82570-F0-00	TRIPLE ENGINES START/STOP SWITCH	1
6X6-82570-90-00	LANYARD SWITCH	1

* For dual station installation



Outboard Rigging & Accessories

RIGGING KITS - FOR MECHANICAL REMOTE CONTROL

6Y8 SINGLE TACHO METER RIGGING KIT (ROUND) 6YR-762G0-80-00

Parts Number	Description	Qty
6Y8-8350T-20-00	TACHOMETER ASSY (ROUND)	1
6Y8-81920-01-00	MULTI-HUB ASSY	1
6Y8-81920-11-00	INLINE HUB ASSY	1
6Y8-82553-21-00	MAIN BUS HARNESS 6 PIN (6.1 M / 20 FT)	1
6Y8-82521-41-00	PIGTAIL BUS HARNESS 4 PIN (2.7 M / 9 FT)	1
6Y8-82521-11-00	PIGTAIL BUS HARNESS 4 PIN (0.6 M / 2 FT)	1
6Y8-82582-11-00	TERMINAL CAP (4 PIN/DEVICE)	2
6Y8-83553-01-00	SYSTEM POWER SUPPLY WIRE (2.4 M / 8 FT)	1
6Y8-2819V-70-00	OWNERS MANUAL	1
6Y8-2819V-80-00	OWNERS MANUAL	1

* Mechanical remote control, switch panel and 10 pin main harness are required separately.



6Y8 SINGLE TACHO + SPEEDO/FMM RIGGING KIT (ROUND) 6YR-762G0-90-00

Parts Number	Description	Qty
6Y8-8350T-20-00	TACHOMETER ASSY (ROUND)	1
6Y8-83500-11-00	SPEEDO & FMM METER ASSY (ROUND)	1
6Y8-81920-01-00	MULTI-HUB ASSY	1
6Y8-81920-11-00	INLINE HUB ASSY	1
6Y8-82553-21-00	MAIN BUS HARNESS 6 PIN (6.1 M / 20 FT)	1
6Y8-82521-31-00	PIGTAIL BUS HARNESS 4 PIN (1.8 M / 6 FT)	1
6Y8-82521-11-00	PIGTAIL BUS HARNESS 4 PIN (0.6 M / 2 FT)	2
6Y8-82582-11-00	TERMINAL CAP (4 PIN/DEVICE)	1
6Y8-8356N-01-00	6Y8 GPS/FUEL WIRE (NMEA 0183)	1
6Y8-83553-01-00	SYSTEM POWER SUPPLY WIRE (2.4 M / 8 FT)	1
6Y8-2819K-R1-00	SET-UP MANUAL	1
6Y8-2819V-70-00	OWNERS MANUAL	1
6Y8-2819V-80-00	OWNERS MANUAL	1

* Mechanical remote control, switch panel and 10 pin main harness are required separately.



6YC SINGLE RIGGING KIT 6Y8-762G0-31-00

Parts Number	Description	Qty
6YC-83710-03-00	6YC MULTI FUNCTION COLOUR DISPLAY	1
6Y8-81920-01-00	MULTI-HUB ASSY	1
6Y8-81920-11-00	INLINE HUB ASSY	1
6Y8-82553-21-00	MAIN BUS HARNESS 6 PIN (6.1 M / 20 FT)	1
6Y8-82521-31-00	PIGTAIL BUS HARNESS 4 PIN (1.8 M / 6 FT)	1
6Y8-82521-11-00	PIGTAIL BUS HARNESS 4 PIN (0.6 M / 2 FT)	1
6Y8-82582-11-00	TERMINAL CAP (4 PIN/DEVICE)	2
6Y8-8356N-01-00	6Y8 GPS/FUEL WIRE (NMEA 0183)	1
6Y8-83553-01-00	SYSTEM POWER SUPPLY WIRE (2.4 M / 8 FT)	1
6YC-2819U-70-00	OWNER'S MANUAL	1
6YC-2819U-80-00	OWNER'S MANUAL	1

* Mechanical remote control, switch panel and 10 pin main harness are required separately.



6YC COUNTER ROTATION RIGGING KIT 6Y8-762R0-01-00

Parts Number	Description	Qty
704-48207-P1-00	704 TWIN TOP MOUNT REMOTE CONTROL	1
6YC-83710-03-00	6YC MULTI FUNCTION COLOUR DISPLAY	1
6Y8-82570-04-00	PANEL SWITCH ASSY	1
6Y8-81920-01-00	MULTI-HUB ASSY	2
6Y8-82553-31-00	MAIN BUS HARNESS 6 PIN (7.6 m / 25 ft)	1
6Y8-82521-11-00	PIGTAIL BUS HARNESS 4 PIN (0.6 M / 2 FT)	1
6Y8-82521-31-00	PIGTAIL BUS HARNESS 4 PIN (1.8 M / 6 FT)	1
6Y8-82521-41-00	PIGTAIL BUS HARNESS 4 PIN (2.7 M / 9 FT)	1
6Y8-82582-11-00	TERMINAL CAP (4 PIN/DEVICE)	3
6Y8-82582-01-00	TERMINAL CAP (2 PIN/POWER)	1
6Y8-8356N-01-00	6Y8 GPS/FUEL WIRE (NMEA 0183)	1
6Y8-83553-01-00	SYSTEM POWER SUPPLY WIRE (2.4 M / 8 FT)	1
6K1-8258A-40-00	10 PIN MAIN HARNESS 8 M (26 FT)	1
61B-8258A-01-00	10 PIN MAIN HARNESS 9.5 M (32 FT)	1
90149-05M05-00	SCREW	4
95380-05600-00	NUT. HEX	4
92990-05600-00	WASHER PLAIN	4
92990-05100-00	WASHER SPRING	4
6YC-2819U-70-00	OWNER'S MANUAL	1
6YC-2819U-80-00	OWNER'S MANUAL	1



Outboard Rigging & Accessories

HARNESSES



DBW MAIN HARNESS (16-PIN)

Part Number	Length	Price
6X6-8258A-50-00	3.7 m (12 ft)	
6X6-8258A-60-00	5.2 m (17 ft)	
6X6-8258A-00-00	6 m (20 ft)	
6X6-8258A-10-00	7 m (23 ft)	
6X6-8258A-20-00	8 m (26 ft)	
6X6-8258A-30-00	10 m (32 ft)	
6X6-8258A-40-00	12 m (38 ft)	



MAIN BUS HARNESS (6-PIN)

Part Number	Length	Price
6Y8-82553-41-00	9.1 m (30 ft)	
6Y8-82553-31-00	7.6 m (25 ft)	
6Y8-82553-21-00	6.1 m (20 ft)	
6Y8-82553-11-00	4.6 m (15 ft)	
6Y8-82553-50-00	3.0 m (10 ft)	
6Y8-82553-01-00	0.3 m (1 ft)	



PIGTAIL BUS HARNESS (4-PIN)

Part Number	Length	Price
6Y8-82521-51-00	3.6 m (12 ft)	
6Y8-82521-41-00	2.7 m (9 ft)	
6Y8-82521-31-00	1.8 m (6 ft)	
6Y8-82521-21-00	0.9 m (3 ft)	
6Y8-82521-11-00	0.6 m (2 ft)	
6Y8-82521-01-00	0.3 m (1 ft)	



SYSTEM POWER SUPPLY WIRE

Supplies electric power from the key switch to the digital network

6Y8-83553-01-00



MULTI-HUB

Distributes the digital signal and electric power to the gauges and the other hubs. (Multi-Hub includes ending resistor cap 6Y8-85371-01)

6Y8-81920-01-00



SINGLE HUB (INLINE HUB)

6Y8-81920-11-00



GREY MAIN BUS CONNECTION CAP WITH RESISTOR (6-PIN)

Ending resistor. Cap for "BUS" on Multi Hub.

6Y8-85371-01-00



RED POWER CONNECTION CAP (2-PIN)

Cap for "POWER" on Multi Hub.

6Y8-82582-01-00



WHITE PIGTAIL CONNECTION CAP (4-PIN)

Cap for "DEVICE" on Multi Hub.

6Y8-82582-11-00

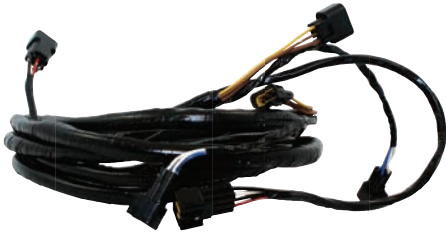

DBW 2ND STATION HARNESS 1

Primary harness (3-4-6 pin)

Part Number	Length	Price
6X6-8258A-G1-00	5 m (16 ft)	
6X6-8258A-H1-00	8 m (26 ft)	
6X6-8258A-J1-00	12 m (38 ft)	



DBW 2ND STATION HARNESS 2

Secondary harness (2-12 pin)

Part Number	Length	Price
6X6-8258A-B1-00	5 m (16 ft)	
6X6-8258A-D1-00	8 m (26 ft)	
6X6-8258A-F1-00	12 m (38 ft)	



6Y9 MULTI SENSOR HARNESS

To connect multi sensor (6Y9) to Hub

6Y9-83553-60-00



6Y9 DISPLAY CONVERSION HARNESS

To connect 6Y9 LCD colour display to Hub

6Y9-83553-40-00



DBW MAIN BUS ADAPTOR HARNESS

To connect DBW control to Hub

6Y9-83553-00-00



6Y9 FUEL WIRE

To connect up to 4 tanks to 6Y9 colour display

6Y9-8356N-10-00



6Y9 GPS WIRE

To connect GPS to 6Y9 colour display

6Y9-8356N-01-00



6Y8 GPS/FUEL WIRE

To connect GPS/Tanks to 6Y8 gauge

6Y8-8356N-01-00

HARNESSES



MAIN HARNESS (7-PIN / 10-PIN)

Pin	Part Number	Length	Price
7-pin	688-82586-50-00	5 m (16 ft)	
10-pin	688-8258A-50-00	5 m (16 ft)	
10-pin	688-8258A-60-00	6 m (19 ft)	
10-pin	688-8258A-70-00	7 m (23 ft)	
10-pin	6K1-8258A-40-00	8 m (26 ft)	
10-pin	61B-8258A-01-00	9.5 m (32 ft)	



MAIN HARNESS EXTENSION (7-PIN / 10-PIN)

Pin	Part Number	Length	Price
7-pin	688-82586-11-00	2 m (7 ft)	
7-pin	688-82586-31-00	3 m (10 ft)	
10-pin	688-8258A-10-00	2 m (7 ft)	
10-pin	688-8258A-30-00	3 m (10 ft)	



703 CONTROL BOX MAIN HARNESS

Pin	Part Number	Length	Price
7-pin	688-82586-21-00	5 m (16 ft)	
10-pin	688-8258A-20-00	5 m (16 ft)	



TRIM & OIL HARNESS

Part Number	Length	Price
6Y5-83653-00-00	5 m (16 ft)	
6Y5-83653-10-00	6 m (19 ft)	
6Y5-83653-20-00	7 m (23 ft)	
6Y5-83653-30-00	8 m (26 ft)	
6Y5-83653-40-00	9 m (29 ft)	
6Y5-83653-50-00	10.5 m (34 ft)	



MULTI-FUNCTION TILLER HANDLE

Our convenient 6X4 Multi-function Tiller Handle is available as an option for mid-range outboard models.

- Ergonomic design and longer, larger-diameter throttle grip
- Contoured, composite-coated lever for smooth, comfortable shifting
- Easy access Power Trim and Tilt switch for on-the-go operation
- Neat and conveniently positioned LED engine warning lamp
- Key switch and STOP switch easily accessible from the handle
- Built-in NEUTRAL switch and buzzer for simple rigging

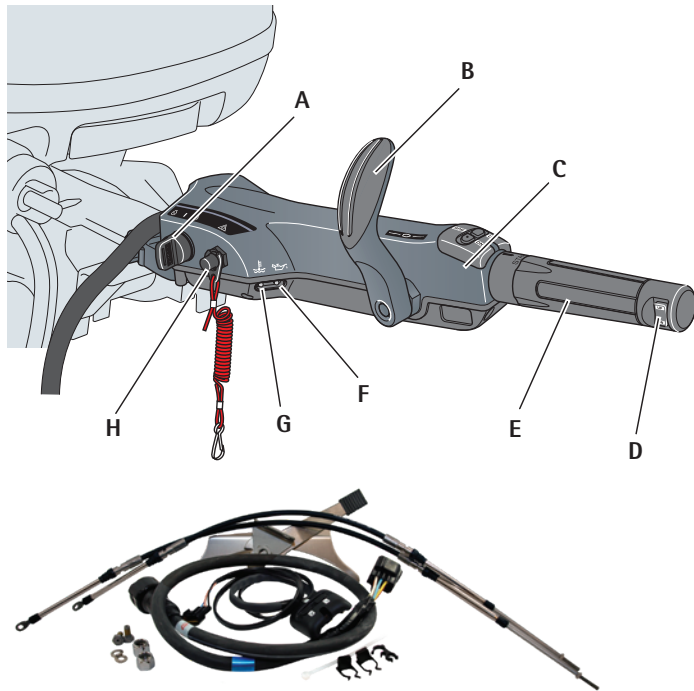

1 - TILLER HANDLE - MAIN BODY

Applicable to F20 – F115.

- A - Engine start/stop
- B - Shift control
- C - Variable trolling switch
- D - PTT Control
- E - Throttle Control
- F - Low oil pressure alert
- G - Overheat alert
- H - Emergency stop lanyard

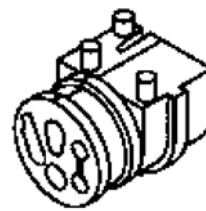

3 - ENGINE GROMMET

Some outboard models require an engine grommet to fit additional wire leads.

2 - FITTING KIT

Fitting kits may differ by outboard model, as shown in the table below

4 - YCOP ATTACHMENT KIT

Required to activate YCOP immobilizer installed with Multifunction Tiller Handle.

Part No	Description	Price	Qty
6Y8-82553-01-00	Main bus harness 0.3 M (1 FT)		1
6Y8-82521-51-00	Pigtail bus harness 3.6 M (12 FT)		1
6Y8-82117-00-00	Pigtail bus with power lead		1
6Y8-81920-11-00	Single hub		2
6Y5-83553-M0-00	Wire harness		1

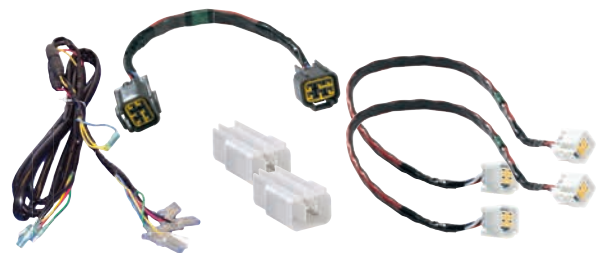

OUTBOARD MODEL	1*		2		3		4	
	TILLER HANDLE - MAIN BODY	PRICE	FITTING KIT	PRICE	ENGINE GROMMET FOR YCOP	PRICE	Y-COP ATTACHMENT KIT	PRICE
F20G			6X4-42102--L0-00					
F20G/F25D/FT25F	6X4-42103-0C-00		Included					
F25G			6X4-42102-F0-00					
F30B/F40F			6X4-42102-82-00		(Not Required)			
F50F/F50H/FT50G/FT50J/ F60C/F60F/FT60D/FT60G			6X4-42102-92-00		6C5-42725-50-00			
F70A	6X4-42103-68-00**				(Not Required)		6Y8-W0035-C0-00	
F80D/F100F			6X4-42102-G1-00					
F80B/F100D			6X4-42102-A2-00		68V-42725-20-00			
F115B/F130A			6X4-42102-C0-00		(Not Required)			

1* F25A/F25D/FT25F are without C/F/G - depending on models - Consult your dealer

** F100F need to install plate 6EK 42121 00 00

Outboard Rigging & Accessories

Y-COP (YAMAHA CUSTOMER OUTBOARD PROTECTION)

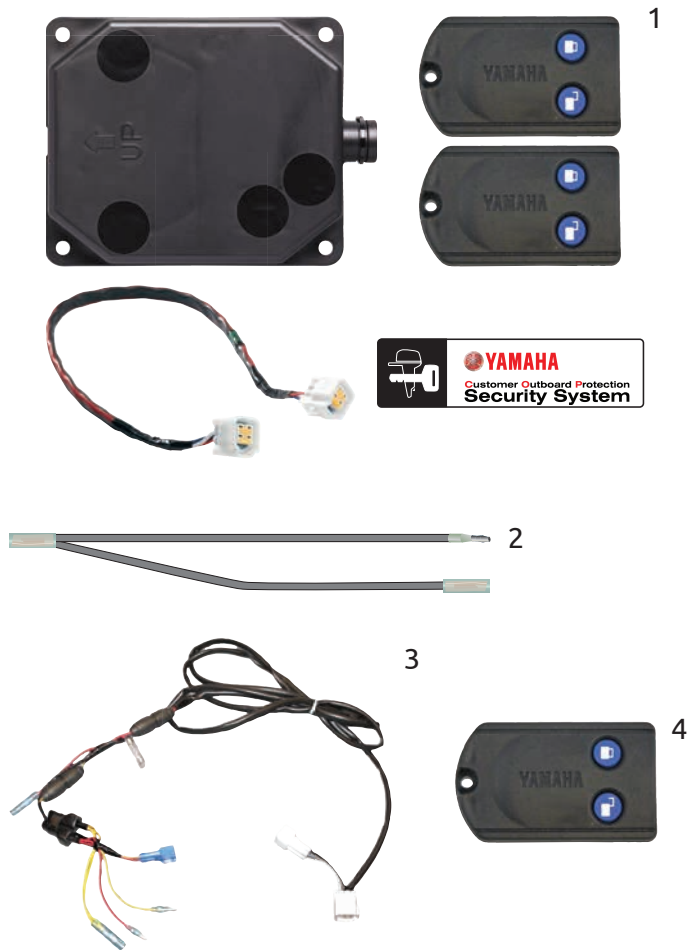

Y-COP (Yamaha Customer Outboard Protection) is a simple, push-button immobilizer for your engine, so that just like your car, it only starts when you want it to. The following table shows the applicable engines:

MODEL	SERIAL NUMBER
F20G/F25G*/F30B/F40F	All engines
F50F	6C1-1030972 -
F50H	All engines
FT50G	6C2-1008760 -
FT50J	All engines
F60C	6C5-1038579 -
F60F	All engines
FT60D	6C6-1013739 -
FT60G	All engines
F70A	All engines
F80D	All engines
F100F	All engines
F115A	68V-1113062 -
FL115A	68W-1004693 -
F115B	All engines
FL115B	All engines
F130A	All engines
F150A	63P-1106291 -
FL150A	64P-1013389 -
F150D	All engines
FL150D	All engines
F175A	All engines
F200F/F200G	All engines
FL200F/FL200G	All engines
F225F/F250D/F300B	All engines
FL225F/FL250D/FL300B	All engines
F350A	6AW-1004795 -
FL350A	6AX-1002906 -
F375	non helmmaster application
F425	non helmmaster application

* Only applicable with Electrical model

PLEASE CONTACT YOUR DEALER TO FIND OUT IF YOUR ENGINE IS ALREADY EQUIPED WITH Y-COP.

	PART NUMBER	DESCRIPTION	QTY	PRICE
1	Y-COP Kit	6Y8-W0035-J2-00	1	
Kit is including below parts:				
	6Y8-86260-02-00	Receiver unit (with remote transmitter)	2	
	90167-06M00-00	Pan-Tapping Screw	4	
	97880-06035-00	Pan-Head Screw	4	
	90201-06M30-00	Plate Washer	8	
	95780-06300-00	Nylon Nut	4	
	6Y8-82521-11-00	Pigtail Bus Harness 4 Pin (0.6 M / 2 FT)	1	
	6Y8-48277-00-00	YCOP decal	4	
	6Y8-28107-96-00	Y-COP Owner's and Installation Manual	1	
	Part Number	Description		Price
2	6H5-81315-00-00	Y-COP power distribution wire (for multiple engines/mechanical control)		
3	6Y8-81315-00-00	Y-COP power distribution wire (for multiple engines/DBW control)		
4	6AA-86261-00-00	Remote transmitter (for replacement)		

Steering & Steering Systems



STEERING WHEELS

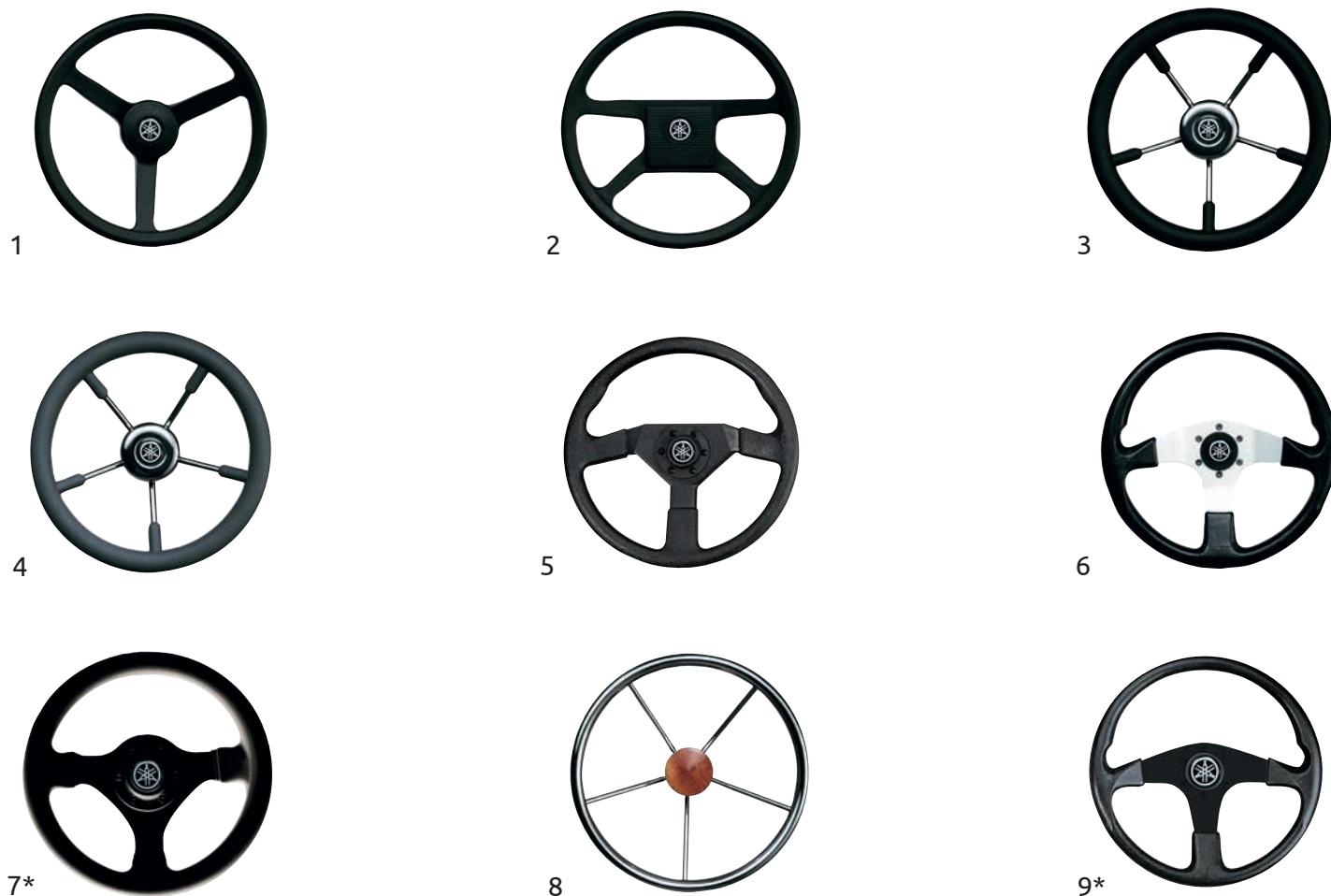

#	PART NUMBER	DIAMETER (MM)		PRICE
1	YMM-24001-00-BK	335	STEERING WHEEL BLACK LONG SPOKE	
2	YMM-24002-00-BK	342	STEERING WHEEL BLACK 4-SPOKE	
3	YMM-24005-00-BK	350	STEERING WHEEL BLACK 5-SPOKE	
4	YMM-24005-00-GY	342	STEERING WHEEL GREY 5-SPOKE	
5	YMM-24003-00-BK	350	STEERING WHEEL BLACK	
6	YMM-24007-00-BS	350	STEERING WHL BLACK/SILVER METAL	
7*	YMM-24004-00-BK	280	STEERING WHEEL BLACK SMALL	
8	YMM-24006-00-CH	345	STEERING WHEEL CHROME 5-SPOKE	
9*	YMM-24007-00-BK	350	STEERING WHEEL BLACK	
* To fit these wheels, the special hub (part number YMM-24000-01-00) is also required.				
-	YMM-24000-01-00	-	HUB FOR STEERING WHEELS (X63)	

MECHANICAL STEERING SYSTEMS



Y12 Helm/Bezel



Y25 Bezel



Y24 Helm/Bezel



Y22 Helm (fast-connect system)



Y23 Helm (non self-centring fast-connect system)

All these systems are highly responsive and are designed and built to our exacting standards of safety, durability and comfort. The Y22 and Y23 helms (or Y20 kit) can be used for all types of applications. Our Y23 helm has a special non self-centring mechanism, which means the wheel won't return automatically to the straight ahead position after a turn. Both these helms have to be installed with a Y25 Bezel, which is available in 20° and 90° versions.

Number of turns lock-to-lock: Y12 - approx 2.5 Y22/Y23 - approx 3.8 Y24 - approx 3

The Y12 (or Y10 kit) is for smaller boats with engines below 40kW (or below 55hp). Y24 can be applied if a simpler, more conventional system is required.

Y10 COMPLETE KIT FOR ENGINES BELOW 40KW (OR BELOW 55HP) INCLUDING Y11, Y12 AND STEERING WHEEL YMM-24003-00-BK

FEET	CM	Part Number	Part Name	Price
8'	244	YMM-22208-00-00	CABLE Y10 STEERING 8	
9'	274	YMM-22209-00-00	CABLE Y10 STEERING 9	
10'	305	YMM-22210-00-00	CABLE Y10 STEERING 10	
11'	335	YMM-22211-00-00	CABLE Y10 STEERING 11	
12'	366	YMM-22212-00-00	CABLE Y10 STEERING 12	
13'	396	YMM-22213-00-00	CABLE Y10 STEERING 13	
14'	427	YMM-22214-00-00	CABLE Y10 STEERING 14	
15'	457	YMM-22215-00-00	CABLE Y10 STEERING 15	

Y11 STEERING CABLE (TO BE USED WITH Y12)

Part Name	Part Number	Price
Y12 Helm/Bezel	YMM-22400-00-00	
Y22 Helm (fast-connect system)	YMM-22500-00-00	
Y23 Helm (non self-centring fast-connect)	YMM-22500-10-00	
Y24 Helm/Bezel	YMM-22510-00-00	
Y25 Bezel (90° version)	YMM-22550-00-00	

FEET	CM	Part Number	Part Name	Price
7'	213	YMM-22007-00-00	CABLE Y11 STEERING 7	
8'	244	YMM-22008-00-00	CABLE Y11 STEERING 8	
9'	274	YMM-22009-00-00	CABLE Y11 STEERING 9	
10'	305	YMM-22010-00-00	CABLE Y11 STEERING 10	
11'	335	YMM-22011-00-00	CABLE Y11 STEERING 11	
12'	366	YMM-22012-00-00	CABLE Y11 STEERING 12	
13'	396	YMM-22013-00-00	CABLE Y11 STEERING 13	
14'	427	YMM-22014-00-00	CABLE Y11 STEERING 14	
15'	457	YMM-22015-00-00	CABLE Y11 STEERING 15	
16'	488	YMM-22016-00-00	CABLE Y11 STEERING 16	
17'	518	YMM-22017-00-00	CABLE Y11 STEERING 17	
18'	549	YMM-22018-00-00	CABLE Y11 STEERING 18	
20'	610	YMM-22020-00-00	CABLE Y11 STEERING 20	

Y20 COMPLETE KIT FOR ALL ENGINES (INCLUDING Y21, Y22, Y25 AND STEERING WHEEL YMM-24007-00-BK

FEET	CM	Part Number	Part Name	Price
10'	305	YMM-22310-00-00	CABLE Y20 STEERING 10	
11'	335	YMM-22311-00-00	CABLE Y20 STEERING 11	
12'	366	YMM-22312-00-00	CABLE Y20 STEERING 12	
13'	396	YMM-22313-00-00	CABLE Y20 STEERING 13	
14'	427	YMM-22314-00-00	CABLE Y20 STEERING 14	
15'	457	YMM-22315-00-00	CABLE Y20 STEERING 15	
16'	488	YMM-22316-00-00	CABLE Y20 STEERING 16	

Y21 STEERING CABLE (TO BE USED WITH Y22/Y23/Y24)

FEET	CM	Part Number	Part Name	Price
8'	244	YMM-22108-00-00	CABLE Y21 STEERING 8	
9'	274	YMM-22109-00-00	CABLE Y21 STEERING 9	
11'	335	YMM-22111-00-00	CABLE Y21 STEERING 11	
13'	396	YMM-22113-00-00	CABLE Y21 STEERING 13	
14'	427	YMM-22114-00-00	CABLE Y21 STEERING 14	
15'	457	YMM-22115-00-00	CABLE Y21 STEERING 15	
16'	488	YMM-22116-00-00	CABLE Y21 STEERING 16	
17'	518	YMM-22117-00-00	CABLE Y21 STEERING 17	
18'	549	YMM-22118-00-00	CABLE Y21 STEERING 18	
19'	579	YMM-22119-00-00	CABLE Y21 STEERING 19	
22'	671	YMM-22122-00-00	CABLE Y21 STEERING 22	
25'	762	YMM-22125-00-00	CABLE Y21 STEERING 25	

ACCESSORIES FOR MECHANICAL SYSTEMS

Some outboard models require additional accessories for the connection between the steering cable and the engine.

Description	Part Number	Price
Clamp block to support steering cables (aluminium and stainless steel)	YMM-22601-00-00	
Splash well mounting support for steering cables (corrosion resistant)	YMM-22602-00-00	
Clamp block to support steering cables (corrosion resistant painted steel)	YMM-22603-00-00	
Clevis for YMM-22601-00-00, YMM-22602-00-00 or YMM-22603-00-00	YMM-22610-00-00	
Clevis for YMM-22601-00-00, YMM-22602-00-00 or YMM-22603-00-00	YMM-22611-00-00	

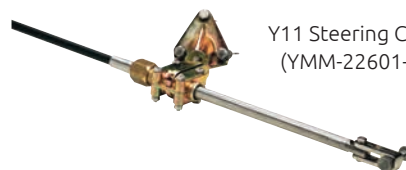

Y11 Steering Cable with Transom Support (YMM-22601-00-00) using Clamp block.



Clevis YMM-22610-00-00



Clevis YMM-22611-00-00

STEERING GUIDE ATTACHMENT KITS

These kits are required for connection between the steering cable end and the outboard's steering hook.

Model	Part Number	Price
F8C(-03/2007)/FT8D(-03/2007)	68T-61350-00-00	
F8C(04/2007-)/FT8D(04/2007-)/F9.9J/FT9.9L	68T-61350-10-00	
9.9F/15F/F9.9C/FT9.9D/F15A	63V-61350-00-00	
FT9.9A/F9.9B	6G8-61350-00-00	
F15C/F20B	6AH-61350-00-00	
20C/20D/25B/25N/25V/30D/30G/40Q	689-61350-02-00	
F25D/FT25F/F30B/F40F	6BG-61350-00-00	
40V/50H/F50A/FT50C	63D-61350-00-00	
F20A/F25A/FT25B/F30A/F40B/C/D/F50F/H/F60A/C/F/FT50G/J/FT60B/D/G/F70A/40X	65W-61350-00-00	
F25G	6FM-61350-00-00	
50G/60F/70B/75C/90A/75A/85A	688-61350-10-00	
F80A/B/F100A/D/F	67F-61350-00-00	
F100F/F115B/F130A	6EK-61350-00-00	
F100B/F115A/F150A/F175A/V4/V6 (2 & 4 stroke)	6E5-61350-02-00	
Tie-Bar Kit		
F115 to F300 (V6) Adjustable distance: 600-800mm	6E5-61301-01-00	



Outboard Rigging & Accessories

STEERING HOOKS

Model	Type	Part Number	Price
6C/D/8C/9.9D/15D/40Q	Ball post type, not for F8B/F9.9A/B/25J	676-48511-02-00	
F6A/F8C/FT8D/F9.9C/FT9.9D/F9.9F/FT9.9G/F9.9J/FT9.9LF15A/9.9F/15F	Steering guide type	63V-48511-01-00	
F8A/B/F9.9A/B/25J/30D ('87-'96)	Ball post type	6G8-48511-10-00	
F8A/B/F9.9A/B/25J/30D ('87-'96)	Steering guide type	6G8-48511-20-00	
F15C/F20B		6AH-48511-01-00	
20C('85-'96) 20D/25B/25D/N/30A/G ('85-'89)	Ball post type/Steering guide type	689-48511-02-00	
20D/25N ('90-'00)	Ball post type/Steering guide type	6L2-48511-00-00	
20D/25N ('01-) 25J/30D ('94-)		6J8-48511-01-4D	
25J/30DETO ('99-'01)	Steering guide type	6J8-48511-52-00	
F20A/F25A/F25D/F25G/FT25B/FT25F/F30A/F30B/F40B/F40F/F50F/F50H/ FT50B/FT50G/FT50J/F60A/F60C/F60F/FT60B/FT60D/FT60G/F70A/40X	Steering guide type	65W-48511-01-00	
25B/50G/60F/70B	Steering guide type	6H3-48511-52-00	
25B/Q/40H/50D/50G/60F/70B/75A/80A/85A/90A/55B ('95--)	Ball post type	688-48511-01-4D	
55B ('92-'94)	Steering guide type	688-48511-51-1D	
55B ('95-'98)	Steering guide type	688-48511-52-00	
55B ('90-'94) 75A/85A ('90-'93)	Ball post type	688-48511-01-4D	
75C/90A	Steering guide type	688-48511-12-00	
25Q/40H/50D	Steering guide type	6H4-48511-51-4D	
40V/Y/F40A/F45A/50H/F50A/B/FT50B/C		63D-48511-01-00	
F80A/F80B/F100A/F100D	Steering guide type	67F-48511-01-00	
F115A	Steering guide type	68V-48511-01-00	

Filters and Fuel Accessories



FUEL FILTERS

Keeping your fuel clean really is an important issue where boating is concerned. Contaminated fuel affects performance and can increase the wear and tear on your engine. The trouble is that countless small dirt particles are already in the fuel before it gets anywhere near your boat - and that's where Yamaha Water Separating Fuel Filters come in. They are designed to be the most efficient systems available for removing dirt before it can enter the pumps and injection system. Without one of these, dirty, unfiltered fuel could block the internal fuel passages, causing the engine to run poorly - or even to fail.

Instead of the standard 35/27-micron filter, the Yamaha 10-micron filter will protect your engine by removing dirt, water and small foreign particles. These superior 10-micron filters are strongly recommended for all engines, especially HPDI and EFI models.

However, it's important to choose a fuel filter with the right capacity for your engine and to regularly maintain it, to avoid reduced performance and engine damage. A simple rule of thumb is to ensure that the litres-per-hour (LPH) of the filter is greater than that of the engine. This figure can be found in your owner's manual.

Remember, a filter that is too big or too good cannot cause problems, but one that is too small or dirty can restrict fuel flow, possibly resulting in engine failure.

GENUINE YAMAHA WATER SEPARATOR/FUEL FILTER:

Corrosion-resistant and specifically designed to fit into smaller areas. Recommended for outboards up to 70HP.

Filter features:

- Manufactured from lightweight resin material.
- Comes with In & Out connectors (can be swapped)
- Clear bowl to allow easy checking of flow and filtering
- 10-micron filter element
- Fluid capacity of 60cc
- Water separation capacity of 99% or more



Water Separator Filter
907-94469-09-00

Water Separator Filter
907-94469-05-00

Water Separator Filter
907-94469-07-00

WATER SEPARATOR FILTERS

Description	Horsepower	Part Number	Price
Water Separator Filter	Up to 70HP	907-94469-09-00	
Water Separator Filter by 40 pieces bulk	Up to 70HP	907-94469-08-00	
Water/Fuel Separator Filter 10-micron including connectors in 8/O8mm	Up to 175HP	907-94469-05-00	
Water/Fuel Separator Filter 10-micron including connectors in 10/O8mm	Up to 350HP	907-94469-07-00	

Replacement filters:

Replacement Filter 10-Micron (including O-ring) - Up to 70HP	907-94469-14-00
Replacement Filter-10 Micron - For 70HP up to 350HP	907-94469-13-00

FILTERS

Description	Part Number	Price
Complete filter kit for engines up to 50hp to 10-micron, 95 litres/hour	YMM-2W095-01-00	
Complete filter kit for engines between 50hp and 115hp 10-micron, 114 litres /hour	YMM-2W114-00-00	
Replacement element for filter kit between 50hp and 115hp	YMM-2E114-00-00	
Complete filter kit for engines over 115hp 10-micron, 227 litres/hour	YMM-2W227-01-00	
Replacement element for filter kit over 115hp	YMM-2E227-01-00	
Complete filter kit for twin engine installation or professional Use 10-micron, 341 litres/hour	YMM-2W341-01-00	
Replacement element for filter kit for twin engine installation or professional use	YMM-2E341-01-00	

(Note: A filter is never "too big". A larger filter will last longer than one which is "just large enough")



Connectors



Filters



Replacement filters

CONNECTORS

Description	Part Number	Price
Connectors for YMM-2W095-00-00 and YMM-2W227-00-00 (1/4" NPT ports):		
Straight fitting for 6.5mm hose	YMM-2FS06-00-00	
Straight fitting for 8mm hose	YMM-2FS08-00-00	
Straight fitting for 10mm hose	YMM-2FS10-00-00	
Elbow fitting for 8mm hose	YMM-2FE08-00-00	
Elbow fitting for 10mm hose	YMM-2FE10-00-00	
Connectors for YMM-2W341-00-00 (3/8" NPT ports):		
Straight fitting for 8mm hose	YMM-2SF08-00-00	
Straight fitting for 10mm hose	YMM-2SF10-00-00	

Outboard Rigging & Accessories

FUEL TANKS AND ACCESSORIES

FUEL TANK:

Description	Part Number	Price
Yamaha 12 litre plastic tank The small tank is coming without the fuel gauge (length 363mm x width 265mm x height 230mm)	6YL-24201-07-0Q	
Yamaha 25 litre plastic tank (length 536mm x width 362mm x height 233mm)	6YK-23201-05-0Q	



FUEL PICKUP:

Description	Part Number	Price
12 litres	979-51242-61-0Q	
25 litres	979-51242-62-0Q	



JERRY CAN:

Description	Part Number	Price
5 litre Jerry can	YMM-5LTRE-00-11	
No-spill spout for 5 litre Jerry can	YMM-NSPSP-T0-00	
1 litre Jerry can	YMM-10LTR-E0-10	



FUEL PIPE JOINT (FEMALE):

Description	Part Number	Price
For 6mm OM side	6G1-24305-05-00	
For 6mm Tank side	6Y1-24305-06-00	
For 8mm OM side	6E5-24305-06-00	
For 8mm Tank side	6Y2-24305-06-00	



FUEL PIPE JOINT (MALE):

Description	Part Number	Price
For 6mm	6G1-24304-10-00	
For 8mm	6E5-24304-20-00	



PRIMARY PUMP:

Description	Part Number	Price
For 6mm	6Y1-24360-52-00	
For 8mm	6Y2-24360-52-00	
6mm F4B/F5A/F6C under the cowl	6BX-24360-00-00	



FUEL HOSE:

Description	Part Number	Price
6mm 30m	90890-56878-00	
8mm 30m	90790-77001-00	



FUEL PIPE COMPLETE:

Description	Part Number	Price
6mm, 3m, both ends with joint	6Y1-24306-55-00	
6mm, 3m, with one joint	6Y4-24306-84-00	
8mm, 3m, both ends with joint	6Y2-24306-56-00	
8mm, 3m, with one joint	6Y2-24306-45-00	
6mm, 3m, Permanent Sealed, both ends with joint	6YL-24306-54-00	
8mm, 3m, Permanent Sealed, with one joint	6YK-24306-44-00	



Note : Fuel pipes and related parts presented in this section are intended for portable use only.

Other Rigging & Accessories



GATEWAY

Enables simple connection of NMEA-compatible devices to the Yamaha Digital Network. Multi-protocol for both 6Y8 and 6Y9 connections.

Wire, lead	6YG-82521-00-00
Interface	6YG-8A2D0-00-00



ANALOGUE GAUGE INTERFACE (AGI)

Enables simple connection of conventional analog gauges to the Yamaha Digital Network. Multi-protocol both for both 6Y8 and 6Y9 connections.

6Y9-8A2D0-30-00



ELECTRONIC COOLING WATER PRESSURE SENSOR

Enables the cooling water pressure to be displayed on the 6Y8 tachometer and 6Y9 colour display.

F30 to F115	60V-8A4L0-1A-00
F150 and up	69J-8A4L0-15-00



ELECTRONIC SPEED SENSOR KIT

Enables speed information to be displayed on the 6Y8 tachometer and 6Y9 colour display.

F30 to F300 (V6)	60V-8A4L1-1A-00
------------------	-----------------



SPEEDOMETER TUBING

8 m	6Y5-83557-10-00
100 m	6Y5-83557-40-00



TRANSOM MOUNTED MULTI-SENSOR

For 6Y9 Display 6Y9-83688-00-00
See page 85 for installation

BATTERY CABLE (FOR BATTERY CHARGING)

Allows electrical power to be drawn from the engine. This battery cable is for battery charging only - not suitable for the starter motor. F9.9J/FT9.9L require a Rectifier/Regulator.

Description	Part No	QTY	Price
Battery Cable	68T-81949-00-00	1	
Fuse (10A-BL)	67F-82151-40-00	2	
Stay, Fuse Box	68T-82171-01-00	1	
Puller, Fuse	67F-2812A-00-00	1	
Washer	92990-06600-00	1	

RECTIFIER/REGULATOR (F9,9L/FT9,9L)

Allows to have stable DC current from the engine. Required for Electric Starter Kit 6DR-W8180-00-00 or individual battery cable 68T-81949-00-00.

Description	Part No	QTY	Price
Rectifier/Regulator Assembly	68T-81960-00-00	1	
Bolt	97080-06012-00	1	
Clamp	90465-10098-00	2	



ELECTRIC STARTER KIT FOR F6A/F8/F8T/F9,9/FT9,9/F25G

Convert a manual start engine into electric start. F25G M Model needs the rotor to be replaced with a rotor with starter gear. F8F/FT8G/F9,9J/FT9,9L/F25G require Rectifier/Regulator.

F6A/F8C/FT8D	6DR-W8180-00-00*
F8F/FT8G/F9,9J/FT9,9L	6DR-W8180-00-00*
F25G	6FM-W8180-00-00*

*kit with rectifier: 6DR-W8180-10-00

Outboard Rigging & Accessories

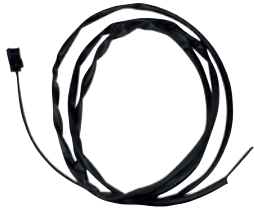

BATTERY ISOLATOR LEADS

Allows the starter battery to be charged first, when other battery is being used for onboard accessories.

Description	Part No	Price
F150A	68F-81949-02-00	
F175 to F350 (except V6 4.2L)	69J-81949-02-00	
F225F/F250D/F300B V6 4.2L	6CE-81949-00-00	
XTO(425/375) battery isolator kit 3.8 mtr / 13ft	6GR-762W0-00-00	



WAVERUNNER BATTERY

Dry charge WaveRunner battery.

Description	Part No	Price
Battery YUASA YB16CLB (19AH)	EU0821100900	



BATTERY CHARGERS

Unique battery charging technology: Fully automatic switch mode charger that analyses the state of the battery, charges and automatically switches to maintenance charging when ready. Includes battery testing, fault detection and float maintenance. Always ensuring a full charge to prolong battery life time. Designed for safety: Spark-free, protected from reverse polarity connections and short-circuit proof. Light and compact: Easy to store and handle.

Yamaha Approved: Tested and approved by Yamaha service engineers to fit and work perfectly with the Yamaha Outboards range.

Quick connection: Combine it with YEC quick connectors - the Built-in Panel Plug, Charger Indicator and Indicator Panel 150 - for reading the charge condition of your battery and/or for easier access between your Yamaha's battery and the YEC-9 or YEC-50 charger.

Battery Charger	Part Number	Price
1 - YEC-9: 6-step charger that can charge the battery of your Yamaha outboard	YME-YEC09-EU-00	
2 - YEC-50: 8-step charger that can charge the battery of your Yamaha outboard.	YME-YEC50-EU-00	

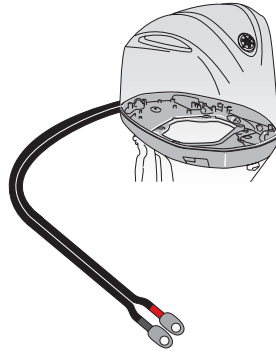

ENGINE BATTERY CABLE

Used to connect Yamaha Outboard Motors to 12V batteries.

Description	Part No	Price
F(T)50 - F(T)60	6C5-82105-01-00	
F70	6C5-82105-U1-00	
F80/F100/F115/F130A	68V-82105-J1-00	
F150	63P-82105-01-00	
F175/F200F/F200G	6DA-82105-01-00	
V6 3.3L	6P2-82105-02-00	
V6 4.2L	6CB-82105-01-00	
F350A	6AW-82105-01-00	

BS BATTERY

Sealed and factory activated battery line by BS.

- No acid handling
- Ready & easy to use
- Multi-positional fitment

Description	Part No	Max Size (mm)	Price
12V-19Ah-260A	907983BB16CL	175x100x175	
12V-18A -260A	907983BTX20L	1475x87x155	

YAMAHA BATTERY BOXES

Size	Max Battery Size	Part Number	Price
Small	Length 190mm x Width 270mm x Height 200mm	YMM-BTBX2-7X-19	
Large	Length 200mm x Width 410mm x Height 200mm	YMM-BTBX4-1X-20	



LIGHTING COIL KIT FOR F4B/F5A/F6C

Allows electrical power to be drawn from the engine

6BX-W8130-A0-00



FUSE CARTRIDGES

Amps	Part No	Price
50	63P-82151-00-00	
60	6P2-82151-00-00	
80	61A-82151-00-00	
100	6CE-82151-00-00	

1



2



ENGINE FLUSH KIT

This extremely useful piece of equipment connects in seconds to your garden hose and allows you to flush out harmful salt and sand. It can also be used for out-of-water operation for tune-ups.

For F4/F5/F6 engines	ABB-FLUSH-JD-00
For F8 to F200 engines	ABB-MOTOR-FL-SH



RIGGING HOSE

Keep your cables protected and uncluttered with a Rigging Hose. Yamaha Hoses are tough yet flexible and are constructed from crush-resistant, UV-protected material to ensure a longer life span. Hoses are mounted using a chromium-plated copper or plastic bracket and come in black, gray or metallic blue colours.

Black	25ft/7,62m	MAR-RIGHS-BK-25
Gray	25ft/7,62m	ABB-RIGHS-GY-25
Metallic blue	25ft/7,62m	ABB-RIGHS-BE-25
Black	2,5"/7m XTO	MAR-RHS25-BK-25
White	2,5"/7m XTO	MAR-RHS25-WT-25

RIGGING GROMMETS

These handy devices replace rubber engine grommets on bigger engines and provide positive attachment without the need for clamps. They can be threaded directly onto one end of a rigging hose with Transom Brackets at the other end.

115-250 (2-stroke)	MAR-GROMM-ET-01
F150	MAR-GRMMT-F1-50
F200B/C-F250A/B	MAR-GRMMT-LG-4S



TRANSOM FLANGE

Black	2,5" XTO	MAR-TFLNG-25-BK
White	2,5" XTO	MAR-TFLNG-25-WT

TRANSOM PLATES

Yamaha recommend these transom plates for boats with engines from 60hp and up.

V4/V6 engines aluminium 10mm	YMM-09TP0-00-01
V8 engines aluminium 10mm	YMM-09TP0-00-02



TRANSOM BRACKETS

The tough plastic bracket is easy to install by just threading the Rigging Hose onto it. It requires no clamp, yet provides positive engagement. Use with the rigging Grommet on the other end for quick, easy rigging. When the chromium plated copper "through transom bracket" is used, the rigging hose is fitted with the clamp.



Chrome transom bracket with 2 anodised stainless steel clamps	ABA-THRUT-RA-SM
Plastic transom bracket	MAR-THRUT-RS-M2

TRANSOM BOLTS

Outboard	Part Number	Thread	Total length	Thread length	No Thread length	Boat transom thickness (*)	Price
	90101-12M51-00	M12	95mm	60mm	35mm		
	90101-12M65-00	M12	105mm	50mm	55mm		
	90101-12M03-00	M12	115mm	60mm	55mm	55-65mm	
F25D - F300B	90101-12M05-00	M12	130mm	75mm	55mm	65-75mm	
	901-01120-47-00	M12	150mm	75mm	75mm	75-95mm	
F350A	90101-12031-00(**)	M12	150mm	75mm	75mm	75-95mm	
	90101-12036-00(**)	M12	170mm	75mm	95mm	95-115mm	
XTO	90101-12051-00	HS	A4	BOLT	(85MM)		
	90101-12055-00	HS	A4	BOLT	(200MM)		
	90101-12031-00	HS	A4	BOLT	(150MM)		
	90101-12053-00	HS	A4	BOLT	(110MM)		
	90101-12054-00	HS	A4	BOLT	(180MM)		
	90101-12036-00	HS	A4	BOLT	(170MM)	*std	
	90101-12057-00	HS	A4	BOLT	(230MM)		
	90101-12056-00	HS	A4	BOLT	(210MM)		

* Reference data

** High tension bolts for F350A



Outboard Rigging & Accessories



YAMAHA OUTBOARD CLASSIC LOCK

The Classic Outboard lock is a heavy carbon steel design and fits turnbuckle mounted engines. It has a recessed solid brass lock and noise dampeners that reduce rattle



HIGH SECURITY OUTBOARD TURNBUCKLE LOCK

This outboard lock fits turnbuckle design and has anti-theft by drill protection. Includes noise dampeners to reduce rattle. Complete with two security keys that cannot be duplicated. Exist in two versions: With SSF certification and with SCM certification.



HIGH SECURITY OUTBOARD BOLT LOCK

This outboard lock fits turnbuckle design and has anti-theft by drill protection. Includes noise dampeners to reduce rattle. Complete with two security keys that cannot be duplicated. Exist in two versions: With SSF certification and with SCM certification.

Part Number	Price	Type	Part Number	Price	Type	Part Number	Price
YMM-40003-CL-00		SCM Certified	YMM-40004-SC-M0		SCM Certified	YMM-40005-SC-M0	
		SSF Certified	YMM-40004-SS-F0		SSF Certified	YMM-40005-SS-F0	



OUTBOARD MOTOR COVERS

There is no better way of protecting your Outboard than a genuine Outboard motor cover. These breathable covers are designed to fit like a second skin for every engine in the range from the 2.5hp upwards. Smart and stylish, they are manufactured from a highly durable waterproof fabric resistant to rot, mildew and UV exposure.

Outboard Model	Part Number	Price
F2.5A	YMM-09100-00-00	
F2.5B	YMM-09100-01-00	
F4A	YMM-09101-00-00	
F4B/F5A/F6C	YMM-09101-01-00	
F6A/F8C/F9.9F	YMM-09102-00-00	
F8F/F9.9J	YMM-09102-00-02	
F15C/F20B/F20C	YMM-09103-00-00	
F25G	YMM-09104-00-02	
F30B/F40F	YMM-09105-00-00	
F40D/F50F/F60C	YMM-09106-00-00	
F40G/F50H/F60F	MAR-MTRCV-FS-70	
F70A	YMM-09113-00-00	
F80A-B/F100A-D	YMM-09107-00-00	
F80D/F100F	YMM-09107-00-02	
F115B/F130A	MAR-MTRCV-11-50	
F150D/F174AF200F-G	MAR-MTRCV-F2-01	
F225F/F250D/F300B	MAR-MTRCV-F4-2L	

FLUSHING BAGS

Made out of heavy duty plastic, these bags are designed to hold shape and stand up on their own. After a day of boating, cleanse your engine with fresh water. Just fill the bag until the water passes the intake inlets and idle your engine in neutral for 5 to 10 minutes. Finally, unscrew the drain plug and let the water flow out.

Small flushing bag: for engines up to 60HP, diameter 47 cm - height 70 cm, max. strap length 175 cm, max. water capacity 100 liter
 Large flushing bag: for engines up to 70HP, diameter 70 cm - height 90 cm, max. strap length 250 cm, max. water capacity 300 liter



OUTBOARD VENTED SPLASH COVER

Designed to be fitted while using your engine, this cover provides the ultimate protection against scratches and UV rays.

The tight fit allows on and off water usage. Perfect on the waves, perfect on the trailer...

- UV stable, breathable, felt lined and water resistant.
- High quality material and finish.
- Features a breathable mesh around the intake ports.

Type	Part Number
F100F, F80D	YME-MCVR1-00-GY
F115B/BET, F130A	YME-MCVR1-15-GY
F150G, F175A, F200B/F/G	YME-MCVR2-00-GY
F30B/F40F	YME-MCVRF-34-GY
F300B, F250D, F225F	YME-MCVR3-00-GY
F70A, FT70, F60F, FT60G, F50H	YME-MCVR5-67-GY



TRAILER SUPPORT

The Yamaha Trailer Support stops your outboard motor moving excessively whilst your boat is being towed on a trailer. Quickly and easily installed over the port trim rod, this support prevents long term damage to both the boat and the engine. One Yamaha Trailer Support will provide adequate support for the F115A up to V6 series. V8 models will require two supports. Please note this product does not work with the F115B or F130A.



Description	Part Number	Price
TRAILER SUPPORT	MAR-MTSPT-YM-10	



YAMAHA TIE DOWNS

Both include two 25mm x 1.80m straps rated for 540 kg.

Type	Part number
Blue, cam-lock buckle	ACC-0SS58-40-28
Blue, ratcheting	ACC-0SS58-40-30



TRAILER SUPPORT

Provides adequate support while trailering. Quickly and easily installs over the port trim rod. Single trim ram models.

Type	Part number
Trailer support	MAR-MTSPT-SR-00

FENDER SOCKS

These high specification fender socks have been produced in a UV and saltwater resistant material. The socks come in black with a white Yamaha logo.

Description	Part Number	Price
0 - 6 metres (fits 13 x 50cm fender)	YMM-09FS0-00-01	
6 - 10 metres (fits 15 x 60cm fender)	YMM-09FS0-00-02	



YAMAHA INFLATABLE LIFEVEST 165N

Buoyancy: Rated 150 N, actual buoyancy 165 N (33 g CO² gas bottle). Ergonomic shape: Short on chest and cutaway sides. Rounded neck for superior comfort. Hardwearing and flexible outer shell with reflective piping. Visibility of inflated jacket: Yellow air chamber + 300 cm² retro-reflecting tapes. Backstrap: 40 mm polypropylene: ensures perfect body fit when lifevest is inflated. CE EN ISO 12402-3 12401

Description	Part Number	Price
INFLATABLE LIFEVEST 165N	D16-INFLV-B4-00	

YAMAHA ADULTS LIFEVEST ORANGE 100N

Self-righting capacity. Head is supported above neck. Buoyancy provided by polythylene foam. Outershell 100% polyester. Fluorescent orange for optimum visibility. 100cm² retro-reflecting stripes.

Description	Part Number	Price
LIFEVEST ORANGE 100N SMALL	D16-LVADT-B6-0S	
LIFEVEST ORANGE 100N MEDIUM	D16-LVADT-B6-0M	
LIFEVEST ORANGE 100N LARGE	D16-LVADT-B6-0L	
LIFEVEST ORANGE 100N XLARGE	D16-LVADT-B6-1L	



YAMAHA KIDS LIFEVEST ORANGE 100N

100 Newton category jacket. Self-righting capacity, keeps the child's head out of the water. Buoyancy: polythylene foam. Large roll-around collar with increased buoyancy providing added comfort and improved head support. Visibility: Bright orange colour and retro-reflecting tapes. Comfortable to wear: front floatation panel is split in 2 for increased comfort, adjustable crotch piece. Closure: adjustable waist belt with plastic clip, hem tightening drawstring, neck closing strap. Grab handle and loop in the back to attach a safety line.

Description	Part Number	Price
LIFEVEST ORANGE 100N 1-2YRS	D16L-VKID-B6-05	
LIFEVEST ORANGE 100N 2-5YRS	D16-LVKID-B6-07	
LIFEVEST ORANGE 100N 5-8YRS	D16L-VKID-B6-11	
LIFEVEST ORANGE 100N 8-10YRS	D16-LVKID-B6-13	

LIFEVEST RE-ARMING KIT

Your inflatable lifevest must be serviced and thoroughly inspected at regular intervals, to make sure it is fully operational. We advise you to check the cartridge if your lifevest has been stored in a damp atmosphere and, as a safety precaution, we recommend the replacement of the cartridge at the beginning of the season. This kit includes a CO₂ gas cylinder (33g gas weight) and hydrostatic release mechanism and opener.

Description	Part Number	Price
Life-vest re-arming kit	D16-INFLA-M1-33	





TILT LIMITER

The tilt limiter will help improve customer satisfaction in applications where the top cowling would come in contact with the boat at full tilt. (Adjacent list shows applicable engine serial numbers) Check with your dealer for installation validation following owner manual instruction.

Model	Starting Serial Number	Tilt Limiter Kit	Price
F50H	6C1-1047118-	6C5-825EY-00-00	
F60F	6C5-1053953-	6C5-825EY-00-00	
FT50J	6C2-1014367-	6C5-825EY-00-00	
FT60G	6C6-1020951-	6C5-825EY-00-00	
F70A	6CJ-1019836-	6C5-825EY-00-00	
F80B	6D7-1014351-	6D8-825EY-00-00	
F100F	All engine	63P-825EY-01-00	
F100D	6D9-1020147-	6D8-825EY-00-00	
F115A	68V-1124466-	63P-825EY-01-00	
FL115A	68W-1005001-	63P-825EY-01-00	
F115B	All engine	63P-825EY-01-00	
FL115B	All engine	63P-825EY-01-00	
F130A	All engine	63P-825EY-01-00	
F150A	63P-1106291-	63P-825EY-01-00	
FL150A	64P-1013389-	63P-825EY-01-00	
F150D	All engine	63P-825EY-01-00	
FL150D	All engine	63P-825EY-01-00	
F175A	All engine	63P-825EY-01-00	
F200F	All engine	63P-825EY-01-00	
FL200F	All engine	63P-825EY-01-00	
F200G	All engine	6CE-825EY-00-00	
FL200G	All engine	6CE-825EY-00-00	
F225F	6CL-1001428-	6CE-825EY-00-00	
FL225F	6CM-1000253-	6CE-825EY-00-00	
F250D	6CG-1003350-	6CE-825EY-00-00	
FL250D	6CH-1000945-	6CE-825EY-00-00	
F300B	6CE-1005964-	6CE-825EY-00-00	
FL300B	6CF-1002506-	6CE-825EY-00-00	



SPRAY PAINT

Scratches can cause rust or other types of damage. Fix them quickly and effectively with our high-quality, durable Yamaha aerosols and primers. They've been developed specifically for marine use and offer the best colour match for Yamaha outboards. Box 6 x 400ml Cans.

Description	Part Number	Price
Ocean Blue (for OM until 1983)	YMM304000B10	
Marine Blue (for OM from 1983 until 1993)	YMM30400MB10	
Bluish Grey Metal (for OM from 1994)	YMM30400GM10	
Bluish Grey Metal 1 (for F30 to F350 OM from 2008)*	YMM30400GM10	
Bluish Grey Metal 2 (F2.5 to F25)	YMM30400GM20	
Dark Blue (for origin OM)	YMM30400DB10	
Top Coat	YMM30400TC10	
Filling Primer	YMM30400FP10	
Zincprimer (anti-corrosive for aluminium parts)	YMM30400ZP10	
Propeller White (All aluminium prop)	YMM30400PW10	

* For previous model colour codes consult your Yamaha Dealer



OUTBOARD MOTOR KEYS



300 and 700 series - Key cover replacement
703-82577-00-00



300 and 700 series - 18mm Switch cap replacement
6K1-82532-00-00



OM KEY NUMBER:	PART NUMBER	PRICE	MATCHING CAP KEY	PART NUMBER	PRICE
111	90890-55957-00		Cap Key	676-82577-00-00	
112	90890-55958-00		Cap Key	676-82577-00-00	
113	90890-55959-00		Cap Key	676-82577-00-00	
121	90890-55960-00		Cap Key	676-82577-00-00	
122	90890-55961-00		Cap Key	676-82577-00-00	
123	90890-55962-00		Cap Key	676-82577-00-00	
371	90890-55868-00		Cap Key	703-82577-00-00	
372	90890-55869-00		Cap Key	703-82577-00-00	
373	90890-55870-00		Cap Key	703-82577-00-00	
374	90890-55871-00		Cap Key	703-82577-00-00	
375	90890-55872-00		Cap Key	703-82577-00-00	
376	90890-55873-00		Cap Key	703-82577-00-00	
377	90890-55874-00		Cap Key	703-82577-00-00	
378	90890-55875-00		Cap Key	703-82577-00-00	
379	90890-55876-00		Cap Key	703-82577-00-00	
380	90890-55877-00		Cap Key	703-82577-00-00	
381	90890-55878-00		Cap Key	703-82577-00-00	
382	90890-55879-00		Cap Key	703-82577-00-00	
383	90890-55880-00		Cap Key	703-82577-00-00	
384	90890-55881-00		Cap Key	703-82577-00-00	
385	90890-55882-00		Cap Key	703-82577-00-00	
386	90890-55883-00		Cap Key	703-82577-00-00	
387	90890-55884-00		Cap Key	703-82577-00-00	
388	90890-55885-00		Cap Key	703-82577-00-00	
389	90890-55886-00		Cap Key	703-82577-00-00	
390	90890-55887-00		Cap Key	703-82577-00-00	
451	90890-55820-00		Cap Key	676-82577-00-00	
452	90890-55821-00		Cap Key	676-82577-00-00	
453	90890-55822-00		Cap Key	676-82577-00-00	
454	90890-55823-00		Cap Key	676-82577-00-00	
455	90890-55824-00		Cap Key	676-82577-00-00	
456	90890-55825-00		Cap Key	676-82577-00-00	
457	90890-55826-00		Cap Key	676-82577-00-00	
458	90890-55827-00		Cap Key	676-82577-00-00	
459	90890-55828-00		Cap Key	676-82577-00-00	
460	90890-55829-00		Cap Key	676-82577-00-00	
461	90890-55830-00		Cap Key	676-82577-00-00	
462	90890-55831-00		Cap Key	676-82577-00-00	
463	90890-55832-00		Cap Key	676-82577-00-00	
464	90890-55833-00		Cap Key	676-82577-00-00	
465	90890-55834-00		Cap Key	676-82577-00-00	
466	90890-55835-00		Cap Key	676-82577-00-00	
467	90890-55836-00		Cap Key	676-82577-00-00	
468	90890-55837-00		Cap Key	676-82577-00-00	
469	90890-55838-00		Cap Key	676-82577-00-00	
470	90890-55839-00		Cap Key	676-82577-00-00	
721	90890-56004-00		Cap Key	703-82577-00-00	

OM KEY NUMBER:	PART NUMBER	PRICE	MATCHING CAP KEY	PART NUMBER	PRICE
727	90890-56005-00		Cap Key	703-82577-00-00	
730	90890-56006-00		Cap Key	703-82577-00-00	
731	90890-56007-00		Cap Key	703-82577-00-00	
732	90890-56008-00		Cap Key	703-82577-00-00	
733	90890-56009-00		Cap Key	703-82577-00-00	
741	90890-56010-00		Cap Key	703-82577-00-00	
747	90890-56011-00		Cap Key	703-82577-00-00	
750	90890-56012-00		Cap Key	703-82577-00-00	
751	90890-56013-00		Cap Key	703-82577-00-00	
752	90890-56014-00		Cap Key	703-82577-00-00	
753	90890-56015-00		Cap Key	703-82577-00-00	
821	90890-56016-00		Cap Key	676-82577-00-00	
827	90890-56017-00		Cap Key	676-82577-00-00	
830	90890-56018-00		Cap Key	676-82577-00-00	
831	90890-56019-00		Cap Key	676-82577-00-00	
832	90890-56020-00		Cap Key	676-82577-00-00	
833	90890-56021-00		Cap Key	676-82577-00-00	
841	90890-56022-00		Cap Key	676-82577-00-00	
847	90890-56023-00		Cap Key	676-82577-00-00	
850	90890-56024-00		Cap Key	676-82577-00-00	
851	90890-56025-00		Cap Key	676-82577-00-00	
852	90890-56026-00		Cap Key	676-82577-00-00	
853	90890-56027-00		Cap Key	676-82577-00-00	

2 KEY SET INCLUDING PLASTIC CAP KEY.

OM Key number:	Part number	Price
457	6X6-82511-09-A1	
462	6X6-82511-09-A2	
463	6X6-82511-09-A3	
827	6X6-82511-09-A4	
832	6X6-82511-09-A5	
833	6X6-82511-09-A6	
847	6X6-82511-09-A7	
852	6X6-82511-09-A8	
853	6X6-82511-09-A9	



ANODES

The materials and build quality of a Yamaha engine means it's already highly resistant to corrosion. The addition of a self-sacrificing anode will improve this even further. As a first line of defence, an anode is meant to corrode instead of your engine. It can easily be replaced by another, thereby protecting the engine. However, high-quality Yamaha anodes are more durable than most of their competitors and will need to be changed less often, thereby maximising the protection of your engine.

CYLINDER ANODES

Outboard Model	Part Number	Price
F2.5A / 2B / 3A / F4A / 4A/5C ('90-) / F4B / F5A / F6C	6L5-45251-03-00	
4A/5C ('89) / F8A/B/F9.9A/B ('88)	677-45251-00-00	
4A/5C/F8A/B/F9.9A/B ('89) / 9.9D/15D ('88/'89)	6E0-45251-12-00	
4A/5C ('-88)	6E0-45251-00-00	
6C/D/8C ('90-)	6N0-G5251-00-00	
6C/D/8C ('-89)	6N0-WG525-00-00	
6C/D/8C ('-89)	6E0-45251-12-00	
F6A/B/F8C / F9,9F / F9,9J	68T-45251-00-00	
F8A/B/9.9D/F9.9B/15D / F9.9A ('-94)	6E8-45251-02-00	
F9.9A/FT9.9A ('94-)	6G8-45251-01-00	
FT8D/9.9F/F9.9C/FT9.9D/ FT9.9G / FT9.9L /15F/F15A/F20A / F25A/25B/V/ F25D /30G/H/40V/X/F30A/F40A/B/C/ F50A/F/50H/ FT25B/C ('00-)	61N-45251-01-00	
F15C / F20B	6AH-45251-00-00	
FT25F / F30B / F40F / F60A/C/FT60B / 40V/X/50H/F40A/F50A/B ('-99) / F50H / F60F F25G	67C-45251-00-00	
F50H / F60F / FT50J / FT60G	65W-45251-00-00	
F(L)300A / F(L)350A	6AW-45373-00-00	

TAB TRIM ANODES

F9.9C/F15A	66M-45371-00-00
40Q/50G/55B/PRO50	679-45371-00-00
20C/D/25D/N/30A/D/40H/V/X/50D/H / F40A/ F45A/F50A ('-00)	664-45371-01-00
FT25B/C/F30A/ FT25F / F25G / F30B / F40F / F40A/B/C/F50A/F/ F50H /F60A/C / F60F	67C-45371-00-00
60F/70B/75A/C/PRO75/80A/85A/90A / FT50B ('-00) FT50C/G/ FT50J /FT60B/D/ FT60G / F70A / F80A/B/F100A/D	67F-45371-00-00
100A/115A/B/C/130B/140A/B/F100B/F100F/ F115A/F115B /150A/175A/200A ('-97) 220A/ PROV100	6E5-45371-01-00
150A/175A/200A ('98-) / 150C/F/175B/ D/200B/F/G/225A/F/225B/D / PROV200/ F150A/Z150P/Q/Z175G/H/Z200N / F200F / F(L)200G	6J9-45371-01-00
150A/175A/200A	6K1-45371-00-00
LF150A/L150C/F/L200B/F/LZ150P/LZ200N	6K1-45371-02-00
FL115A/ FL115B /L130B/L140B	6L6-45371-00-00
(L)225C/G/(L)250A/B/ F(L)200A/ F(L)200C / F(L)225A / / F(L)225B / F(L)250A / F(L)250B / F(L)225F / F(L)250D / F(L)300B	61A-45371-00-00
Z200P/(L)2250D/F/(L)Z300A	69L-45371-00-00

BRACKET ANODES

FT8D/FT9.9D/F15A/F20A / F15C / F20B / F25A / F25G (PT model) /FT25B/F30A/30D/F40B/C / 40X/V/FT50C/50H/F60A/FT60B / F70A	65W-45251-00-00
25B/Q/40H/50D/G/55B/60F/70B/75A/C/80A /85A/90A/F80A/B/F100A/D/ F100F/ F(L)115B /PRO50/75 ('90-)	6H1-45251-03-00
40H/50D/60F/70B/80A/90A ('89)	99999-03935-00
40H/50D/60F/70B/80A/90A ('-88)	688-45251-01-00
25B/FT25B/F30A/40V/F40A/B/F45A / FT50A/B/50G/H/PRO50/55B/60F/70B	663-45251-00-00
40V/F40A/F45A/50H/F50A/FT50B	63D-45251-01-00
115A/140A/150A/175A/200A/220A	6E5-45251-00-00
100A/115B/C/ F(L)115A/ (L)130B/(L)140B	6G5-45251-02-00
PROV100/150/200/Vmax	6AW-45251-00-00

(L)F150A/(L)150A/C/F/175A/B/D/F	6AW-45251-00-00
(L)200A/B/F/G/(L)225A/B/C/D/G/(L)250A/B	6AW-45251-00-00
(L)Z150P/Q/Z175G/H/(L)Z200N/P/	6AW-45251-00-00
Z250D/F/ F(L)200A / F200B / F(L)200C	6AW-45251-00-00
F(L)225A / F(L)225B / F225C / F(L)250A	6AW-45251-00-00
F(L)250B / (L)Z300A / F(L)300A / F(L)350A	6AW-45251-00-00
F(L)225F / F(L)250D / F(L)300B	6AW-45251-00-00
F(L)200F / F(L)200G	6AW-45251-00-00

STERN-DRIVE DIESEL ANODES

Type / Engine Model	Part Number	Price
Anode for intercooler - ME370 / ME422	N51-45251-00-00	
Anode for heat exchanger - ME370 / ME422	N51-11325-01-00	
intermediate Anode - ME422	6U0-45251-00-00	
Anode for TRP Drive (rear) - ME422	6U4-45251-00-00	
Anode for TRP Drive (front) - ME422	6U4-45373-00-00	
Anode for SP drive - ME422	6U3-45251-00-00	

F300A/F350A (V8) ANODES

Type	Part Number	Price
Anode for thermostat cover	6AW-1132R-00-00	
Anode for rectifier/regulator	6E5-11325-00-00	
Bolt Anode	6AW-11325-00-00	
Cylinder head anode	67F-11328-00-00	
Anode for engine block	6AW-1132P-00-00	
Anode for Exhaust cover	6AW-1132M-00-00	
Anode for Exhaust	99999-03946-00	
Anode for Exhaust	6AW-1132L-00-00	
Anode for engine block	63P-11325-01-00	
Anode intermediate plate/Exhaust Guide	6AW-1132T-00-00	
Anode intermediate plate/Exhaust Guide	6AW-1132S-00-00	
Anode intermediate plate/Exhaust Guide	63P-11325-11-00	

IMPELLERS

This vital component of the water pump ensures a continuous supply of the correct amount of coolant to the engine. Like all our parts, a Yamaha Impeller is intended for use with a Yamaha engine, so it's advisable to specify one every time it needs replacing.

Outboard/Engine Model	Part Number
2CMHS / 2D,2DMHS	646-44352-01
3AMHS / 3B,3BMHS / F2.5AMHS / F2.5BMHS	6L5-44352-00
4ACMHS / 4CMHS / 5CMHS / F4BMHS / F5AMHS / F6CMHS	6E0-44352-00
6CMHS / 8CMHS / 8FMHS	6G1-44352-00
E8DMHL,E8DMHS	662-44352-01
F8CMHS / F8FMHS / F9.9FMHS / F9.9JMHS	68T-44352-00
15FMHS / 9.9FMHS / 9.9G,9.9GMHS / F15CMHS / F20BMHS / F20BWHL,F20BMHS / F20CMHL / F9.9HMHS,F9.9HWH1S / FT8DMHX / FT8GMHX / FT9.9GMHX / FT9.9LMHX	63V-44352-01
E15DMHL,E15DMHS,E15D / E9.9DMHS / EK15DMHL	682-44352-03
20DWOS,20DMHOL / 25NMHOS / F20FETL / F20GWHS / F25GWHS	6L2-44352-00
25BWCS / 25BWL,25BWCS,25BMHS,25BWS / 30DETOL, 30DEOS, 30DMHOS, 30DMHOL, 30DMHS / 30HWL / 30HWL,30HMHS,30HWS, E25BMHL,E25BMHS / E40XMHX,E40XWS,E40XMHL,E40XMHS / F20DETL / F25DMHS / F30BETS / F40FETS / F40J,F40JMHL / FT25FETL	6H4-44352-02
E40GMHL,E40GMHS / EK40GMHL	6F5-44352-00
40VMHOS,40VEOS / 40YETOL / 50MHMHOS,50HETOL,50MHMOS / 55BEDS,55BETL / E55CMHL / F40DETL / F40GETL / F40HETL / F50DETL / F50FETL / F50HETL / F60CETL / F60FETL / F70AETL,F70AETX / F70AETX / FT50CETL,FT50CETX / FT50GETL / FT50JETL / FT60DETX / FT60GETX	6H3-44352-00

60FETOL / 70BETOL / 75AETL / 75CETOL / 85AETL,85AETX / 90AETOL,90AETOX / E60HMHD, E60HWDL, E60HMHD, E75BMHDL, E75B	688-44352-03
F100DETL, F100DETX / F80BETL, F80BETX / F80BETX / F90BETL	67F-44352-00
115BETL / 115CETOL / 130BETOL / 150AETX / 150FETOL, 150FETOX / 200AETX / 200FETOX, 200FETOL / 250GETOX / E115AETL / F100BETX, F100BETL / F100FETX / F115AETX / F115BETX / F115BETX, F115BETL / F130AETX / F150AETX / F150BETX / F150FETX / F150GETX / F150LB-2019 / F150XB-2015 / F150XB-2016, F150XB- 2017, F150XB-2018 / F175AETX / F175CETX / F200AETX / F200BETX / F200CETX / F200FETX / F200GETX / F225AETX / F225BETX / F225CETL / F250AETX / F250AETX, F250AETU / F250BETX / F250GETX / F250HETX / F80CEDL, F80CEDX / F80DETX / FL115AETX / FL115BETX / FL150AETX / FL150BETX / FL150DETX / FL150DETX, FL150DETL / FL150FETX, FL150F / FL150GETX / FL175CETX / FL200AETX / FL200BETX / FL200CETX / FL200FETX / FL200GETX / FL225AETX / FL225BETX / FL250AETX / FL250BETX / FL250GETX / FL250HETX / L150AETX / L200AETX / L200FETOL / L250GETOX	6E5-44352-01
F225FETX / F225HETX / F250DETX / F250LETX / F300BETX / F300CETX / F300DETX / FL225FETX / FL225HETX / FL250DETX / FL250LETX / FL300BETX / FL300CETX / FL300DETX	6CE-44352-00
F300AETX / F350AETX / F350XCB-2013 / FL300AETX / FL350AETX / LF350XCB-2013	6AW-44352-00
FL375ASTX / FL425ASTX / XF375NSA-2018 / XF425NSA7-2018	6GR-44352-00
Stern-drive diesel ME370 / ME372 / ME422 / ME432	6TA-12457-00-00

THERMOSTATS

A thermostat regulates the perfect engine operating temperature. A correctly performing thermostat prevents engine over-cooling which can cause dilution of the oil and reduction of filtration, resulting in greater engine wear.

Outboard Model:	Part Number	Price
3A/4A/5C/6C/8C/25N (--'93)/25NWO ('01/'02)	6E5-12411-02-00	
9,9F/15F/25N ('94--)/40V/100A/115C / (L)130B/(L)150F/175D/(L)200F/200G/225D/ (L)250A/(L)Z150P/Z150Q/Z175G/(L)Z200N/ Z200P/225G/(L)250B	6E5-12411-30-00	
F15C/F20B	6AH-12411-00-00	
9,9D/15D/20C/25D/40Q/55B	6F5-12411-03-00	
30D/75C/90A	688-12411-11-00	
50G/60F/70B	6H3-12411-11-00	
F100B/F(L)115A/(L)Z250D/Z250F/(L)Z300A	60V-12411-00-00	
F2,5A	69M-12411-01-00	
F4A/F4B/F5A/F6C/F6A/F8B/F8C/FT8D/ F9,9C/F9,9F/F9,9J/FT9,9A/FT9,9D/FT9,9G/ FT9,9L/F15A/F9,9B/F25A/FT25B/F25D/ FT25F/F30B/F40F/F30A/F40B/F40A/F50A/ FT50B/C/F50F/F50H/FT50G/FT50J/F60A/ FT60B/F60C/F60F/FT60D/FT60G/F70A	66M-12411-01-00	
F25G	6FM-12411-00-00	
F80A/F100A (99/'00')	66M-12411-01-00	
F80A/F100A (01/'--)	67F-12411-01-00	
F100D	6D9-12411-00-00	
F(L)115B	6EK-12411-00-00	
F80B/F100B/F(L)150A/F(L)200A F(L)200C/F(L)225A/F(L)225B/ F225C/F(L)250A/F(L)250B	67F-12411-01-00	
F100F	6FP-12411-00-00	
F(L)225F/F(L)250D/F(L)300B	6CE-12411-00-00	
F(L)200F/F(L)200G/F175A	6DA-12411-00-00	
F(L)300A/F(L)350A	6AW-12411-00-00	
WaveRunner Model:		
FX.../FZS/FZS	60E-12411-01-00	
VX...	6D3-12411-00-00	

PRIMARY FUEL FILTERS

Fuel filters and replacement cartridges with high power filtering to block any small particles in the fuel. Remember to change this filter regularly using genuine Yamaha parts.

Outboard Model	Part Number	Price
3A / F2,5A / F4A	6L5-24251-00-00	
4A / 5C / 6C / 8C	646-24251-02-00	
F4B / F5A / F6A / F6C / F8C / FT8D / F9,9J / FT9,9L	68T-24251-01-00	
F9,9C / FT9,9D / F15A / F25A / FT25B (--'04)	65W-24251-10-00	
F9,9C (1001584 --) / FT9,9D (1001139 --) / F15A (1009198 --) / F25A & FT25B (1013331 --)'04 --)	61N-24563-10-00	
F25G	6D8-24563-00-00	
F30A / F40B	65W-24251-10-00	
FT50B (--'00)	61N-24563-10-00	
FT50B ('01--)	68V-24563-00-00	
F60A / FT60B (--'03)	68V-24563-00-00	
F60A / FT60B ('04--)	61N-24563-10-00	
F50F / FT50G / F60C / FT60D (--'06)	68V-24563-00-00	
F50F / FT50G / F60C / FT60D ('07--)	6D8-WS24A-00-00	
F30B / F40F / F50H / F60F / FT50J / FT60G / F70A	6D8-WS24A-00-00	
F80A / F100A (--'01)	67F-24251-02-00	
F80A / F100A ('02--)	61N-24563-10-00	
F80B / F100D / F(L)115A (--'06)	68V-24563-00-00	
F80B / F100D / F(L)115A ('07--) / F(L)115B	6D8-WS24A-00-00	
F100F	6D8-24563-00-00	
F(L)150A / F(L)200A / F200B / F(L)225A (--'06)	65L-24563-00-00	
F(L)150A / F(L)200A / F200B / F(L)225A ('07--)	6P3-WS24A-01-00	
F(L)200C / F(L)250A (--'06)	6P2-WS245-00-00	
F(L)200C / F(L)250A ('07--)	6P3-WS24A-01-00	
F(L)225B / F225C / F(L)225F (V6 4,2L) / F(L)250D (V6 4,2L) / F(L)300A / F(L)300B (V6 4,2L) / F(L)350A / F(L)200F / F(L)200G / F175A	6P3-WS24A-01-00	
9,9F / 15F / F15C / F20B / 25N / F25D / FT25F / 30D / 40V / 50G / F50A / 60F / 75C / 90A / 100A / F100B / 115C / (L)130B / (L)150F / 175D / (L)200F / 200G / 225D	61N-24563-10-00	
115B	6F5-24563-00-00	
(L)250A	61A-24563-00-00	
225G / 250B	65L-24563-00-00	
(L)Z150P / (L)Z150Q / Z175G / (L)Z200N / Z200P (--'04)	68F-24563-00-00	
(L)Z150P / (L)Z150Q / Z175G / (L)Z200N / Z200P ('05/'06)	68F-24563-10-00	
(L)Z150P / (L)Z150Q / Z175G / (L)Z200N / Z200P ('07--)	6P3-WS24A-01-00	
(L)Z250D / Z250F (--'03)	68F-24563-00-00	
(L)Z250D / Z250F ('04/'06)	68F-24563-10-00	
(L)Z250D / Z250F ('07--)	6P3-WS24A-01-00	
(L)Z300A (--'06)	68F-24563-10-00	
(L)Z300A ('07--)	6P3-WS24A-01-00	

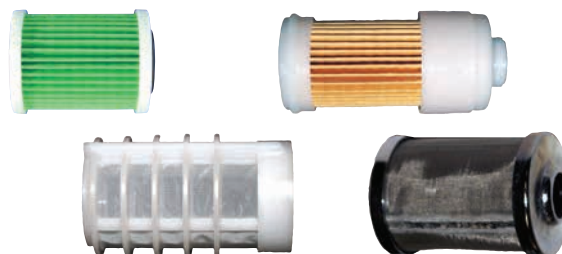

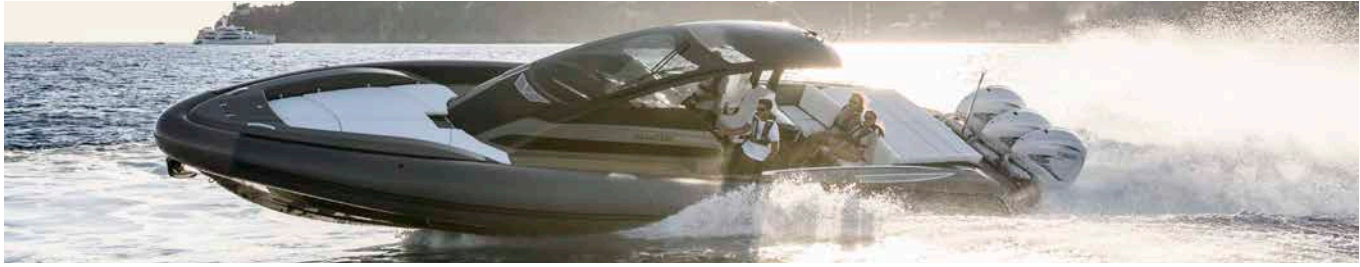

NGK SPARK PLUGS

These provide the ultimate performance for your engine. They're high-quality, reliable and their advanced materials and design provide superior anti-fouling characteristics, which reduce carbon build-up over a wide heat range. "V Type" plugs include a thin centre electrode tip, which is made of precious metal for added corrosion and oxidation resistance. The result: fast, sure starts and less misfiring, even in the coldest weather.

- Ribbed to eliminate flash-over and improve performance
- Highest quality ceramic insulators improve heat dissipation and electrical insulation to provide long term durability
- More Gaskets for peak performance
- Deep-seated copper core provides maximum engine efficiency at high and low speeds
- Projected insulator precision-engineered to prevent fouling and misfiring
- Nickel alloy tip prevents fouling, maximises performance and extends plug life

OUTBOARD MODEL	PART NUMBER	NGK REF.	PRICE
(L)Z150P/Z150Q (VMAX)	94702-00405-00	BKR6EKU	
Z175G/(L)Z200N/Z200P (VMAX)/(L)Z250D/Z250F (VMAX)/(L)Z300A	94702-00404-00	BKR7EKU	
2B	94702-00249-00	BR5HS	
F2,5A/F4A	94701-00248-00	BR6HS	
3A/F6A/F8C/FT8D/F9,9F/F9,9J/FT9,9G/FT9,9L	94702-00274-00	BR6HS10	
4A/5C/20C/25D/40X	94701-00110-00	BR7HS	
6C/8C/9,9D/9,9F/15D/15F/20D/25N/25V/25B/30D/40H/40V	94702-00271-00	BR7HS10	
40Q	94701-00195-00	BR8HS	
30G/50D/50G/50H/55B/60F/70B/75A/75C/80A/85A/90A/100A/115A/115B/115C/140A/150A/150C/150F/175A/175B/175D/200A/200B/200F/200G/225D/(L)250A/(L)250G	94702-00247-00	BR8HS10	
130B/140B/200C/225B/250B/225G (VMAX)	94701-00309-00	BR9HS10	
F8B	94701-00300-00	CR5HS	
F9,9A/F9,9B	94701-00282-00	CR6HS	
F60A/FT60B	94701-00406-00	DPR5EA9	
F9,9C/FT9,9D/F15A/F25A/FT25B/F30A/F40A/F40B/F50A/FT50B/FT50C	94701-00375-00	DPR6EA9	
F15C/F20B/F25D/F25G/FT25F/F30B/F40F/F50F/F50H/FT50G/FT50J/F60C/F60F/FT60D/FT60G	94702-00418-00	DPR6EB9	
F80A/F80B/F100A/F100B/F100D/F(L)150A/F(L)200A/F(L)225A	94702-00391-00	LFR5A11	
F(L)115A/F175A/F(L)200C/F(L)200F/F(L)200G/F(L)225B/F225C/F(L)250A/F(L)250B/F(L)300A/F(L)350A/F(L)225F/F(L)250D/F(L)300B	94702-00400-00	LFR6A11	
F100F	NC	LKR6E-9N	
F4B/F5A/F6C	94702-00372-00	CR6HSB	
F70A	94702-00429-00	LKR7E	
F(L)115B	94702-00437-00	LKR6E	
STERN-DRIVE ESSENCE	94701-00365-00	BR6FS	
WAVERUNNER MODEL	PART NUMBER	NGK REF.	PRICE
XL800/XLT800/GP800/WB800/GP800R	94701-00204-00	BR8ES	
XLT1200/XL1200LTD/GP1200R/GP1300R	94702-00396-00	BR8ES11	
SJ650/650T/650TL/650TX/FX1/PRO TX700/WB700/XL700/WVT700/W.RAIDER 760/WVT760/XL760/WB760/GP760/W.RAIDER 1100/WVT1100/SUV1200/GP1200/XL1200	94701-00195-00	BR8HS	
SJ700/W.RAIDER 700	94701-00110-00	BR7HS	
FX140/FX140 CRUISER/FX160/FX160 CRUISER/FX1100 HO/HO CRUISER/VX 1100 SPORT & DELUXE	94702-00409-00	CR9EB	
FX SHO/FX SHO CRUISER 2008--2014/FX HO/FX HO CRUISER 2009--2014/FZR/FZS 2009--2013/VX1800 2011--2014	94702-00427-00	LFR6A	
FX SVHO/FX SVHO CRUISER/FZS/FZR 2014	94702-0043-500	LFR7A	

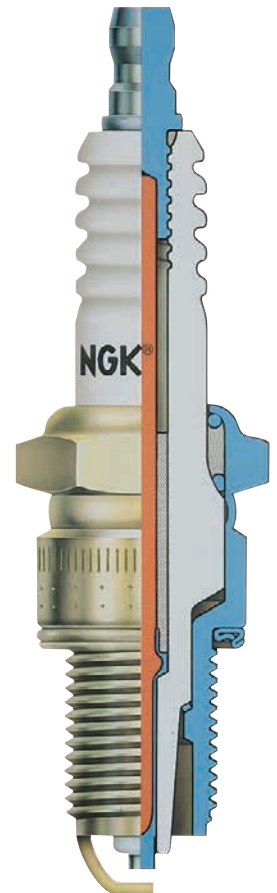

OIL FILTERS

The oil filter is an essential component that contributes to the lifetime of the engine. Compromising on the quality or replacement timing of this part may result in serious technical issues and we always recommend the use of a genuine YAMAHA oil filter. Build quality and high filtering power ensure your engine receives the very highest levels of safety.

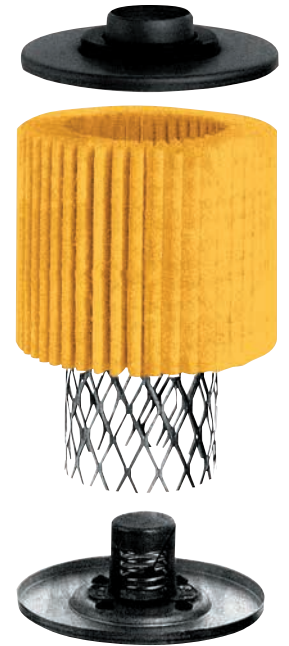

Outboard Model	Part Number	Price
F8A/B/F9,9A/B/FT9,9A (--1989)	6G8-13411-01-00	
F8A/F9,9A/B/FT9,9A (1990--)	6G8-13440-00-00	
F25G	5GH-13440-60-00	
F9,9C 2000--/FT9,9D 2000--/F15A 2000--/F20A 2000--/F25A 2000--/FT25B/F30A/F40A 2000--/F40B '01--/F50A '99--'05/F50F --05/FT50B 2000--/FT50C --05/FT50G --05/F60A --05/F60C --05/FT60B --05/FT60D --05/F80A 2000--/F80B/F100A 2000--/F100B/F100D/F(L)115A/F115B	5GH-13440-30-00	
F15C 07--/F20B 07--/F25D/FT25F/F30B/F40F/F50A 06--/FT50C 06--/FT60B 06--/F50F 06--/FT50G 06--/F60A 06--/F60C 06--/FT60D 06--/F50H/F60F/FT50J/FT60G/F70A/VX CRUISER/DELUXE 08--11/VX SPORT 08/FX/FX HO/FX HO CRUISER 08	5GH-13440-50-00	
F9,9C '98/FT9,9D '99/F15A '98/F20A '98/F25A '98/'99/F40A '99/F40B 2000/F50A '95--'98/FT50B '96--'99/F80A/F100A '99	3FV-13440-20-00	
F(L)150A/F175A/F(L)200A/F(L)200C/F(L)200F/F(L)200G/F(L)225A/F(L)225B/F225C/F(L)250A/F(L)250B/FX SHO/FX SHO CRUISER/FX HO CRUISER/FZR/FZS	69J-13440-03-00	
F100F	5GH-13440-70-00	
F(L)300A/F(L)350A/F(L)225F/F(L)250D/F(L)300B	N26-13440-02-00	
WaveRunner Model	Part Number	Price
FX140/FX140 CRUISER/FX160/FX160 CRUISER/FX-H.O CRUISER/FX-HIGH OUTPUT/VX 1100 SPORT & DELUXE	5GH-13440-30-00	
Stern Drive Model	Part Number	Price
ME 370 STI/ME 372 STI/ME 420 STI/ME 422 STI/ME 432 STI	YD9-09153-00-02	

AIR FILTERS

WaveRunner Model	Part Number	Price
Air filter for: "SJ 700"	62T-14451-00-00	
Air filter for: "VX"	6D3-14451-00-00	
Air filter for: "FX 140/FX 1100"	6B6-14451-01-00	
Air filter for: "FX 1800/FZR/FZS"	6S5-E4451-00-00	
Stern Drive Model	Part Number	Price
Air filter for "ME 372/ME 422/ME 432"	N51-14451-00-00	



ENGINE TIMING BELTS

The timing belt is a vital element of your 4-stroke engine, used to synchronize the movement of valves with the pistons. For 2-stroke HPDI engines the timing belt is used to drive the high pressure fuel pump. The timing belt should be replaced every five years or every 1000 hours of operation (1st maturity reached).

Outboard/Stern Drive Model	Part Number	Price	Remarks
F6A --04 / F8C --04 / FT8D --04 / F9,9F / F9,9J / FT9,9G / FT9,9L	68T-46241-00-00		
F6A 05-- / F8C 05-- / FT8D 05--	68T-46241-00-00		
F8B/FT9,9A/F9,9B	6G8-46241-00-00		
F9,9C/FT9,9D/F15A	66M-46241-00-00		
F15C / F20B	6AH-46241-00-00		
F25A/FT25B/F30A/F40B	65W-46241-00-00		
F40A/F50A/FT50B/C/F60A/FT60B	62Y-46241-00-00		
F25D / FT25F / F30B / F40F / F50F/FT50G/ FT50J / F50H / F60C/ F60F /FT60D / FT60G / F70A	6C5-46241-00-00		
F25G	6FM-46241-00-00		
F80A/B/F100A/B/D/F(L)115A/	67F-46241-00-00		
F100F	6FP-W4624-00-00		
F(L)115B	6EK-W4624-00-00		With rotor bolts
F(L)150A	63P-46241-00-00		
F(L)200A/F(L)225A/	69J-46241-00-00		
F(L)200C / F(L)225B / F225C / F(L)250A / F(L)250B	6P2-46241-01-00		
(L)Z150P / Z150Q / Z175G / (L)Z200N / Z200P (---2003)	68F-46241-00-00		
(L)Z150P / Z150Q / Z175G / (L)Z200N / Z200P (2004--)	68F-46241-10-00		
(L)Z250D/Z250F/(L)Z300A	60V-46241-00-00		
F175A / F(L)200F / F(L)200G	6DA-W4624-00-00		
F(L)300A / F(L)350A	6AW-W4624-00-00		With rotor bolts
F(L)225F / F(L)250D / F(L)300B	6CB-W4624-00-00		With rotor bolts
ME422	YU1-35681-91-95		
ME422 / ME432	6TA-12444-00-00		
ME370 / ME372	6TC-12444-00-00		
ME370 / ME372	6TC-12445-01-00		

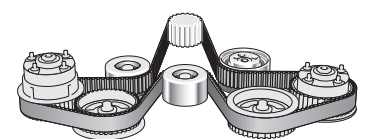

Rigging Order Guide



INDEX

Description	Page
MULTI-FUNCTION TILLER HANDLE	
Single Engine (6Y8 Gauge + 6X4 Multi-function Tiller Handle)	59
MECHANICAL REMOTE CONTROL	
Single Engine (6Y8 Gauges + 703 Side Mount)	60
Single Engine (6YC Gauge + 703 Side Mount)	61
Single Engine (CL7 Gauge + 703 Side Mount)	62
Single Engine (6Y8 Gauges + 6X3 Flush Mount)	63
Single Engine (6YC Gauge + 6X3 Flush Mount)	64
Single Engine (CL7 Gauge + 6X3 Flush Mount)	65
Single Engine (6Y8 Gauges + 704 Top Mount)	66
Single Engine (6YC Gauge + 704 Top Mount)	67
Single Engine (CL7 Gauge + 704 Top Mount)	68
Twin Engine (6YC Gauges)	69
Twin Engine (CL7 Gauges)	70
DBW REMOTE CONTROL (MAIN STATION)	
Single Engine (6YC Gauges + 6X7 Flush Mount)	71
Single Engine (6YC Gauges + 6X6 Top Mount)	72
Single Engine (CL7 Gauges + 6X7 Flush Mount)	73
Single Engine (CL7 Gauges + 6X6 Top Mount)	74
Twin Engine (6YC Gauges)	75
Twin Engine (CL7 Gauges)	76
Triple Engine (CL7 Gauge)	77
DBW REMOTE CONTROL (2ND STATION)	
Single Engine (Flush Mount)	78
Single Engine (Top Mount)	79
Twin Engine	80
Triple Engine	81
XTO CONNECTION	
SCU harness (for Twin XTO engines)	82
SCU harness (for Triple XTO engines)	83

MULTI-FUNCTION TILLER HANDLE

SINGLE ENGINE (6Y8 GAUGE + 6X4 MULTI-FUNCTION TILLER HANDLE)

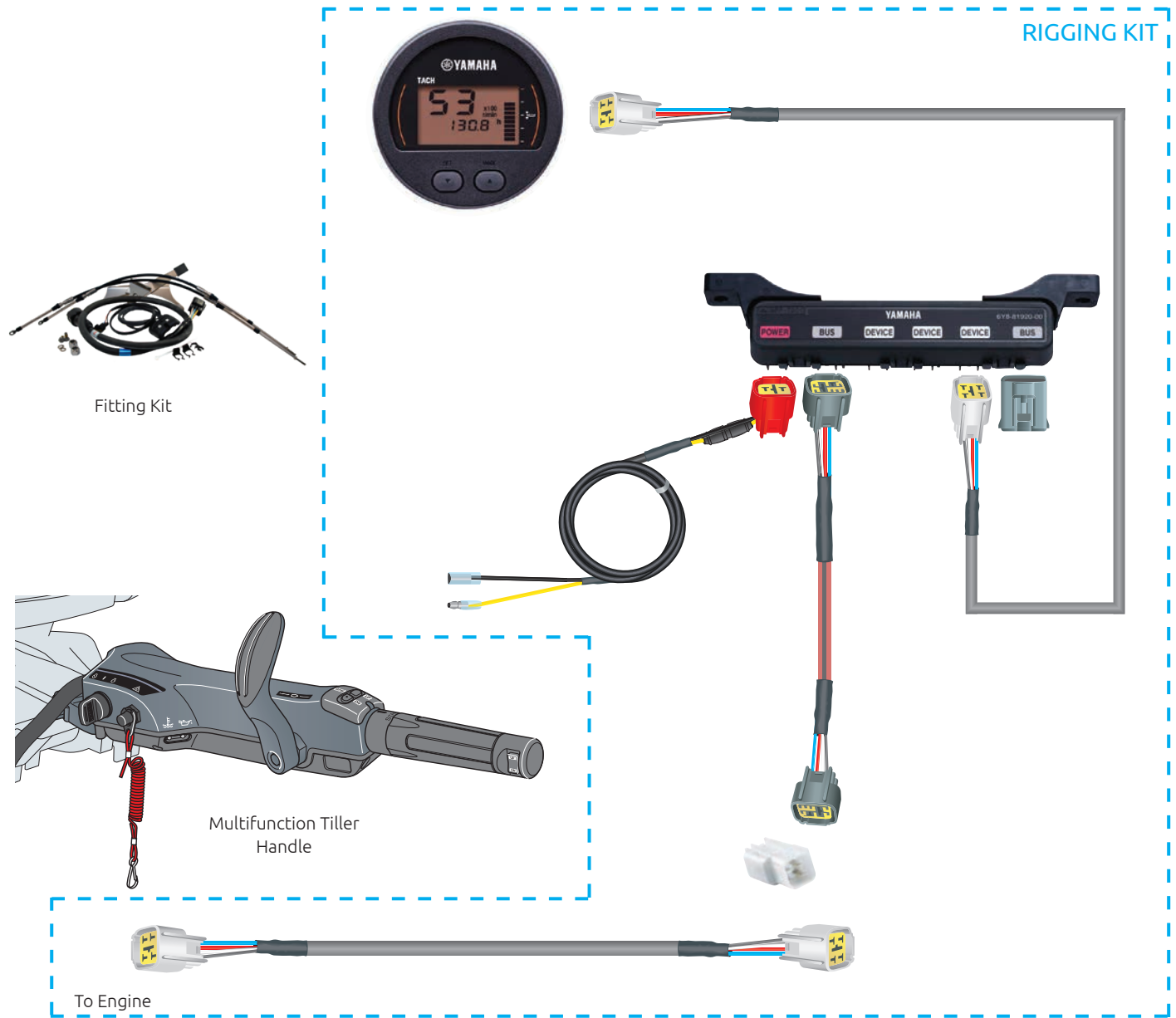

Part Number	Description	Qty	Price
RIGGING KIT			
6YR-762G0-80-00	6Y8 Round Tachometer Kit	1	
MULTI-FUNCTION TILLER HANDLE			
6X4-42103-68-00	6X4 Multi-function Tiller Handle	1	
TILLER HANDLE FITTING KIT			
6X4-42102-82-00	F30B/F40F		
6X4-42102-92-00	F50H/FT50J/F60F/FT60G/F70A		
6X4-42102-A2-00	F80B/F100D	1	
6X4-42102-C1-00	F115B		

Rigging Order Guide

MECHANICAL REMOTE CONTROL

SINGLE ENGINE (6Y8 GAUGES + 703 SIDE MOUNT)

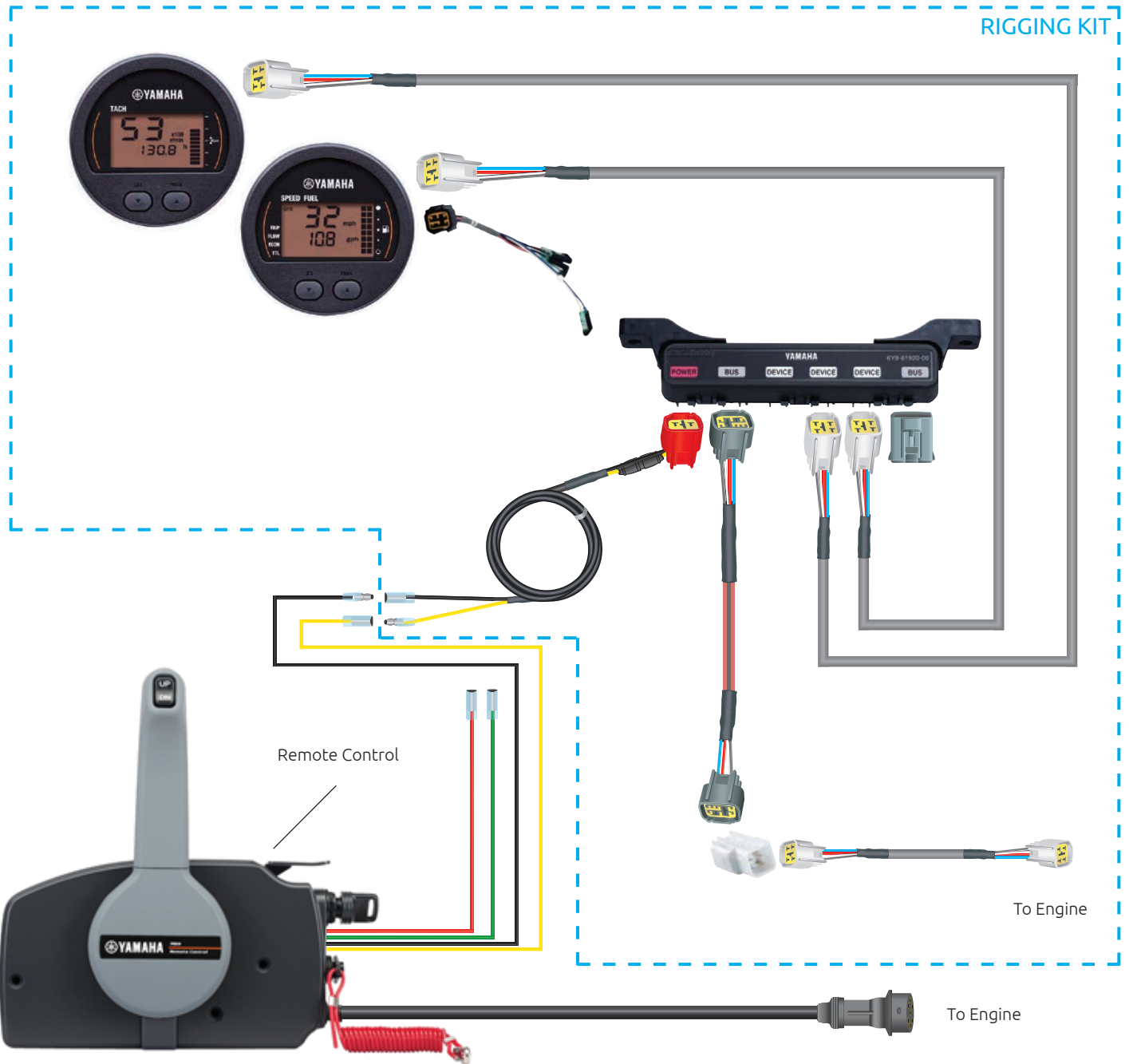

Part Number	Description	Qty	Price
RIGGING KIT			
6YR-762G0-80-00	6Y8 Round Tachometer Kit	1	
6YR-762G0-90-00	6Y8 Round Tacho + Speedo/FMM Kit (Shown above)		
REMOTE CONTROL BOX			
703-48207-22-00	703 Side mount remote control	1	

For Y-COP, Multi-sensor and Gateway installations please see page 85-90

SINGLE ENGINE (6YC GAUGE + 703 SIDE MOUNT)

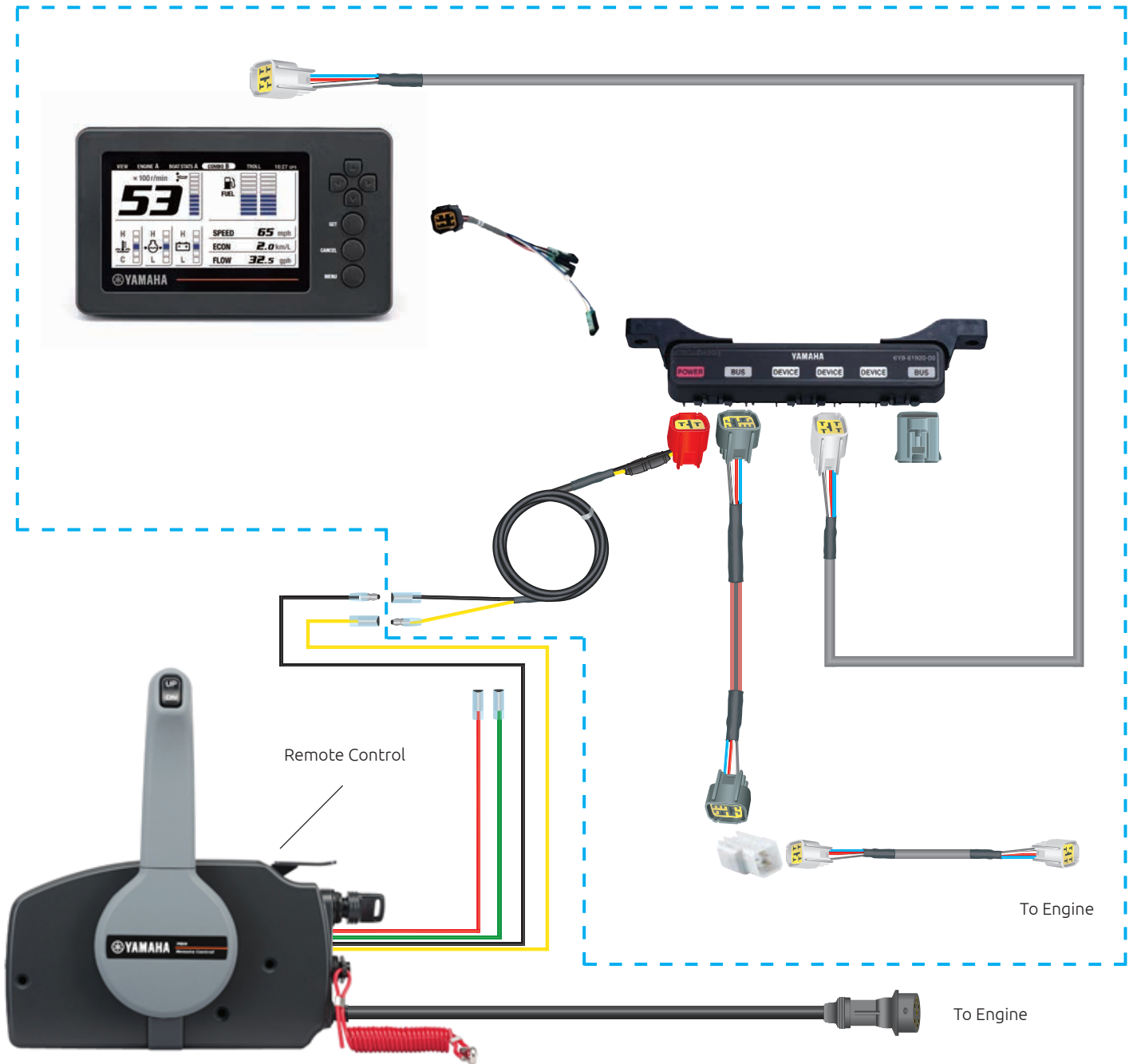

Part Number	Description	Qty	Price
RIGGING KIT			
6Y8-762G0-21-00	6YC Kit	1	
REMOTE CONTROL BOX			
703-48207-22-00	703 Side mount remote control	1	

Rigging Order Guide

MECHANICAL REMOTE CONTROL

SINGLE ENGINE (CL7 GAUGE + 703 SIDE MOUNT)

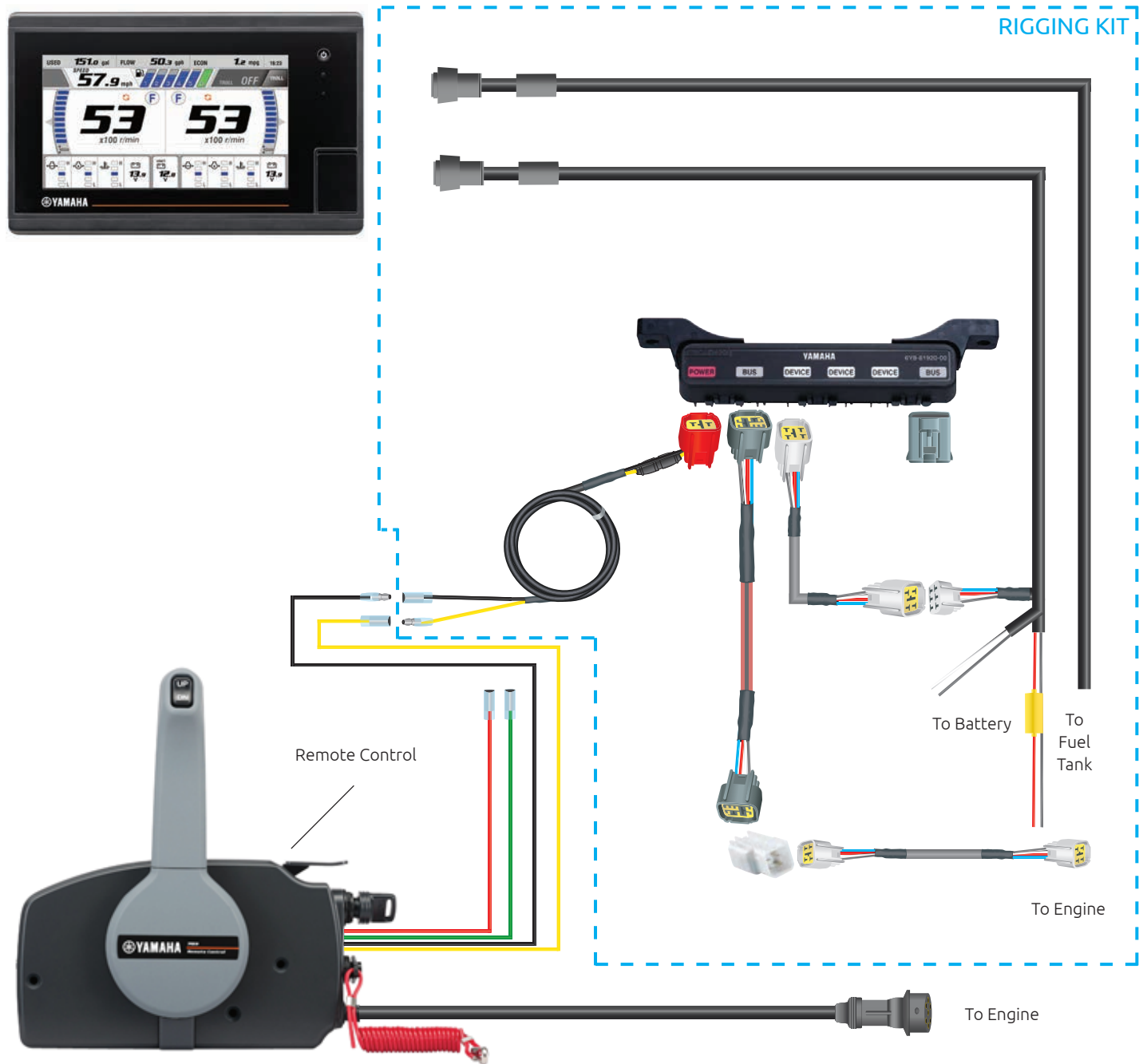

Part Number	Description	Qty	Price
RIGGING KIT			
6YD-762A0-10-00	CL7 Kit	1	
6YD-83710-01-00	CL7 Display		
REMOTE CONTROL BOX			
703-48207-22-00	703 Side mount remote control	1	

For Y-COP, Multi-sensor and Gateway installations please see page 85-90

SINGLE ENGINE (6Y8 GAUGES + 6X3 FLUSH MOUNT)

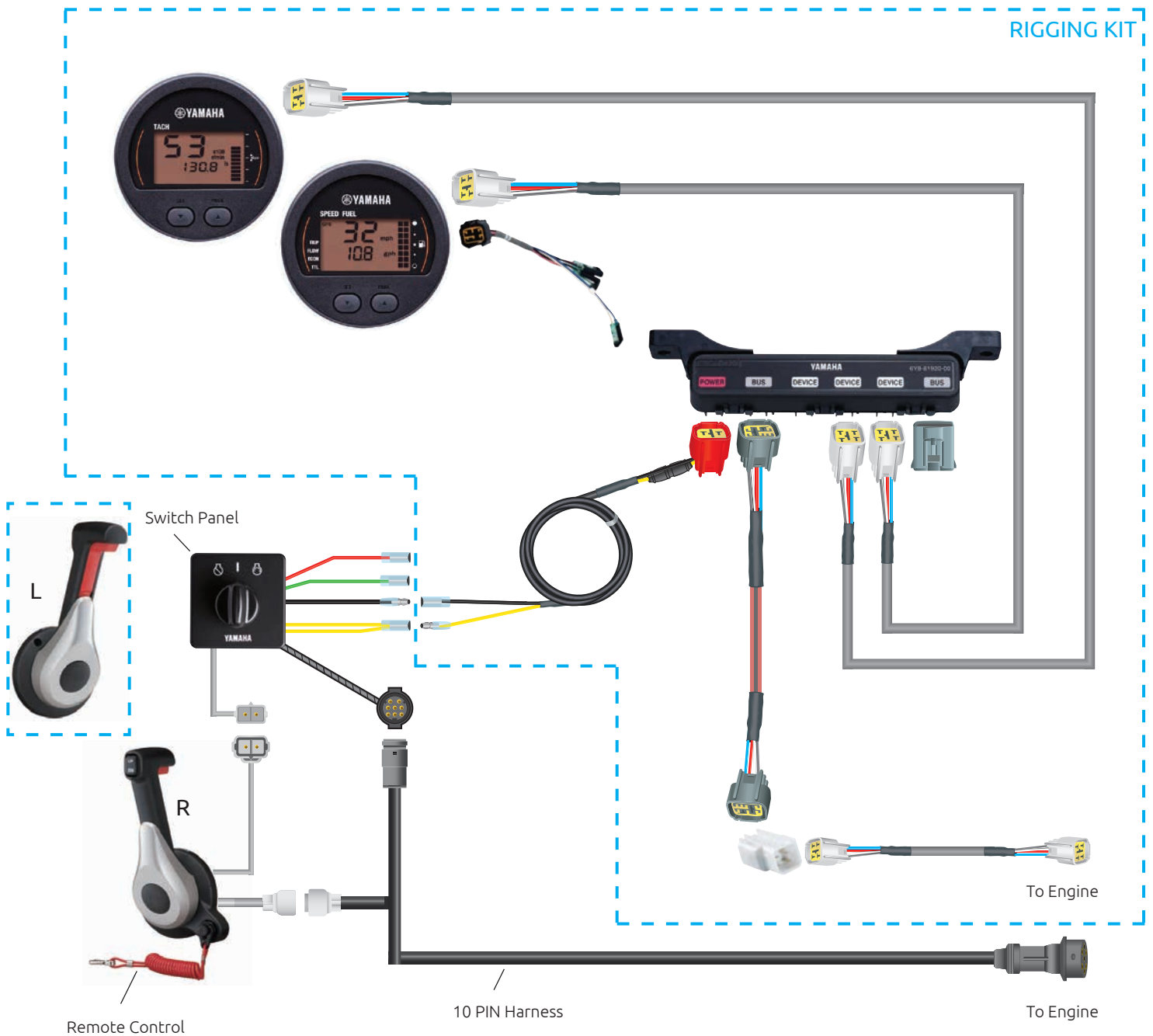

Part Number	Description	Qty	Price
RIGGING KIT			
6YR-W0035-Y3-00	Round Tachometer Kit	1	
6Y8-W0035-E2-00	Round Tacho + Speedo/FMM Kit (Shown above)	1	
REMOTE CONTROL BOX AND SWITCH PANEL			
6X3-48206-10-00	6X3 Flush mount RC (right side)	1	
64D-82570-22-00	Man SW (for right side)	1	
6X3-48206-21-00	6X3 Flush mount RC (left side)	1	
6R5-82570-07-00	Man SW (for left side)	1	
10-PIN HARNESS			
688-8258A-50-00	5 m (16 ft)		
688-8258A-60-00	6 m (19 ft)		
688-8258A-70-00	7 m (23 ft)		
6K1-8258A-40-00	8 m (26 ft)	1	
61B-8258A-01-00	9.5 m (32 ft)		

For Y-COP, Multi-sensor and Gateway installations please see page 85-90

Rigging Order Guide

MECHANICAL REMOTE CONTROL

SINGLE ENGINE (6YC GAUGE + 6X3 FLUSH MOUNT)



Part Number	Description	Qty	Price
RIGGING KIT			
6Y8-W0035-F1-00	6YC LCD Single Kit	1	
REMOTE CONTROL BOX AND SWITCH PANEL			
6X3-48206-10-00	6X3 Flush mount RC (right side)	1	
64D-82570-22-00	Man SW (for right side)	1	
6X3-48206-21-00	6X3 Flush mount RC (left side)	1	
6R5-82570-07-00	Man SW (for left side)	1	
10-PIN HARNESS			
688-8258A-50-00	5 m (16 ft)		
688-8258A-60-00	6 m (19 ft)		
688-8258A-70-00	7 m (23 ft)		
6K1-8258A-40-00	8 m (26 ft)	1	
61B-8258A-01-00	9.5 m (32 ft)		

For Y-COP, Multi-sensor and Gateway installations please see page 85-90

SINGLE ENGINE (CL7 GAUGE + 6X3 FLUSH MOUNT)

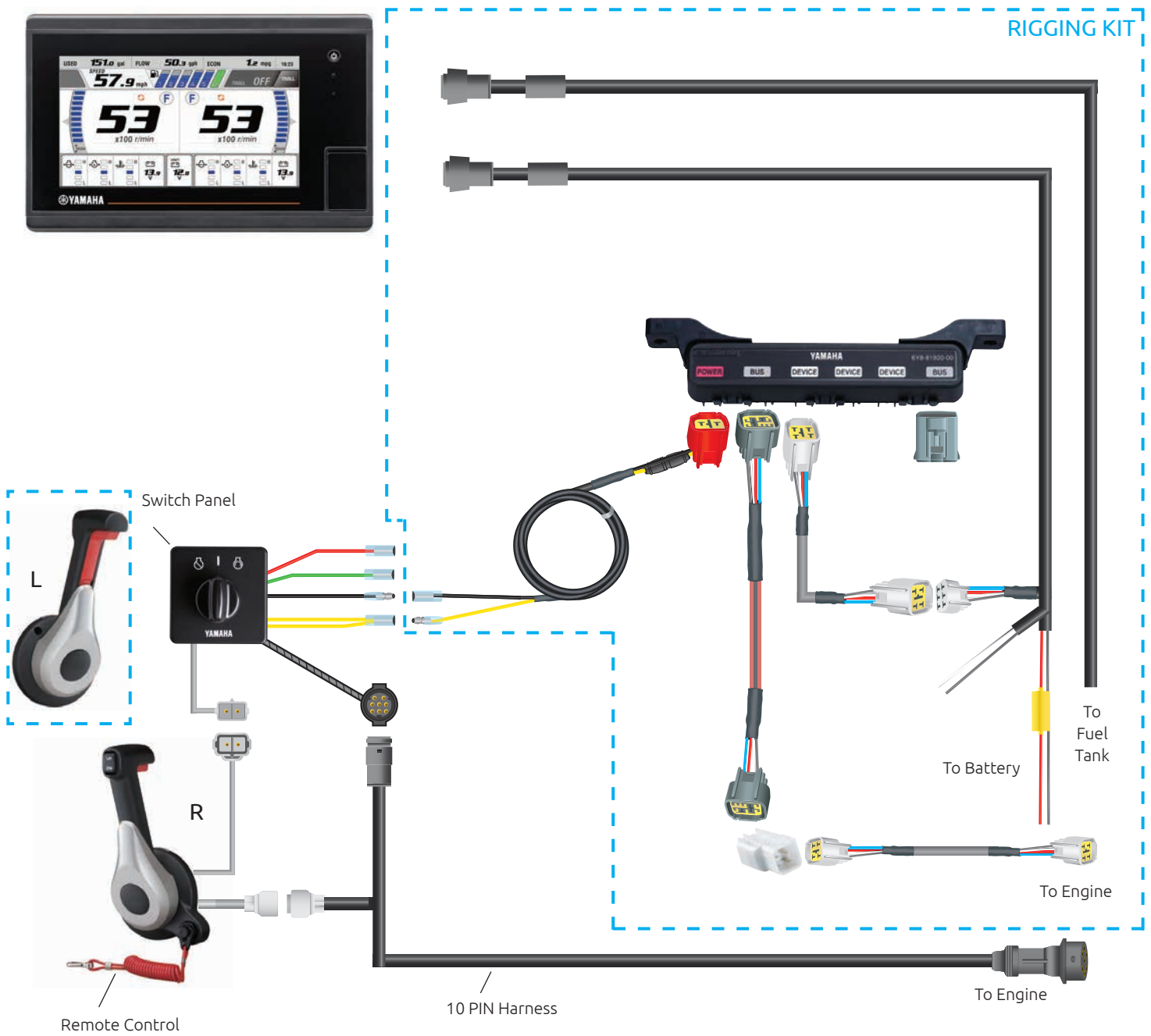

Part Number	Description	Qty	Price
RIGGING KIT			
6YD-762A0-10-00	CL7 Kit	1	
6YD-83710-01-00	CL7 Display	1	
REMOTE CONTROL BOX AND SWITCH PANEL			
6X3-48206-10-00	6X3 Flush mount RC (right side)	1	
64D-82570-22-00	Man SW (for right side)	1	
6X3-48206-21-00	6X3 Flush mount RC (left side)	1	
6R5-82570-07-00	Man SW (for left side)	1	
10-PIN HARNESS			
688-8258A-50-00	5 m (16 ft)		
688-8258A-60-00	6 m (19 ft)		
688-8258A-70-00	7 m (23 ft)	1	
6K1-8258A-40-00	8 m (26 ft)		

For Y-COP, Multi-sensor and Gateway installations please see page 85-90

Rigging Order Guide

MECHANICAL REMOTE CONTROL

SINGLE ENGINE (6Y8 GAUGES + 704 TOP MOUNT)



Part Number	Description	Qty	Price
RIGGING KIT			
6YR-762G0-80-00	6Y8 Round Tachometer Kit	1	
6YR-762G0-90-00	6Y8 Round Tacho + Speedo/FMM Kit (Shown above)	1	
REMOTE CONTROL BOX AND SWITCH PANEL			
704-48205-R0-00	704 Top mount remote control	1	
704-82570-12-00	Single Engine Key Switch	1	
10-PIN HARNESS			
688-8258A-50-00	5 m (16 ft)		
688-8258A-60-00	6 m (19 ft)		
688-8258A-70-00	7 m (23 ft)	1	
6K1-8258A-40-00	8 m (26 ft)		
61B-8258A-01-00	9.5 m (32 ft)		

For Y-COP, Multi-sensor and Gateway installations please see page 85-90

SINGLE ENGINE (6YC GAUGE + 704 TOP MOUNT)



Part Number	Description	Qty	Price
RIGGING KIT			
6Y8-W0035-F1-00	6YC LCD Single Kit	1	
REMOTE CONTROL BOX AND SWITCH PANEL			
704-48205-P1-00	704 Top mount remote control	1	
704-82570-12-00	Single Engine Key Switch	1	
10-PIN HARNESS			
688-8258A-50-00	5 m (16 ft)		
688-8258A-60-00	6 m (19 ft)		
688-8258A-70-00	7 m (23 ft)	1	
6K1-8258A-40-00	8 m (26 ft)		
61B-8258A-01-00	9.5 m (32 ft)		

For Y-COP, Multi-sensor and Gateway installations please see page 85-90

Rigging Order Guide

MECHANICAL REMOTE CONTROL

SINGLE ENGINE (CL7 GAUGE + 704 TOP MOUNT)

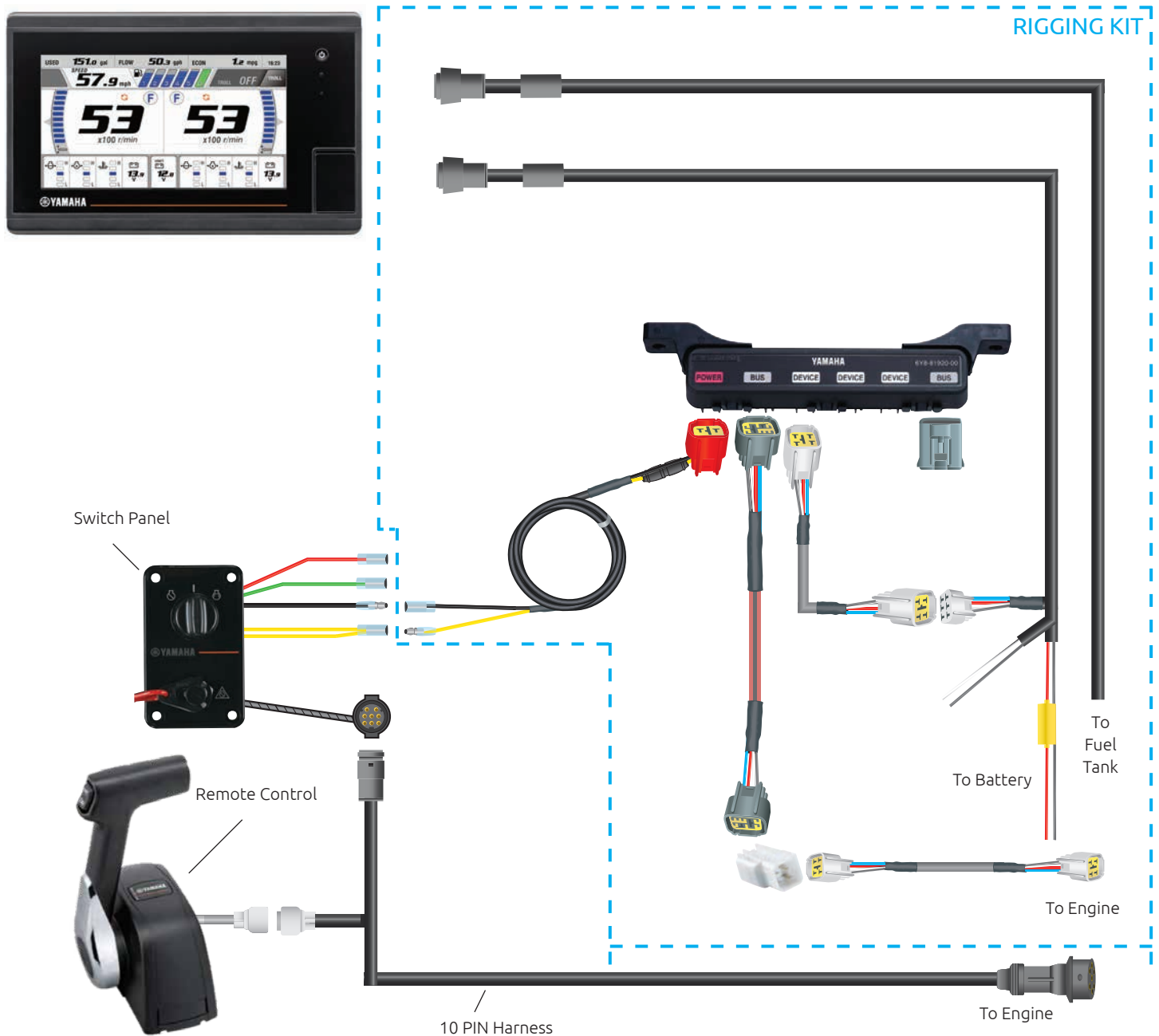

Part Number	Description	Qty	Price
RIGGING KIT			
6YD-762A0-10-00	CL7 Kit	1	
6YD-83710-01-00	CL7 Display		
REMOTE CONTROL BOX AND SWITCH PANEL			
704-48205-P1-00	704 Top mount remote control	1	
704-82570-12-00	Single Engine Key Switch	1	
10-PIN HARNESS			
688-8258A-50-00	5 m (16 ft)		
688-8258A-60-00	6 m (19 ft)		
688-8258A-70-00	7 m (23 ft)	1	
6K1-8258A-40-00	8 m (26 ft)		
61B-8258A-01-00	9.5 m (32 ft)		

For Y-COP, Multi-sensor and Gateway installations please see page 85-90

TWIN ENGINE (6YC GAUGE)



Part Number	Description	Qty	Price
RIGGING KIT			
6Y8-762R0-01-00	6YC Counter Rotation Rigging Kit	1	

Rigging Order Guide

MECHANICAL REMOTE CONTROL

TWIN ENGINE (CL7 GAUGES)

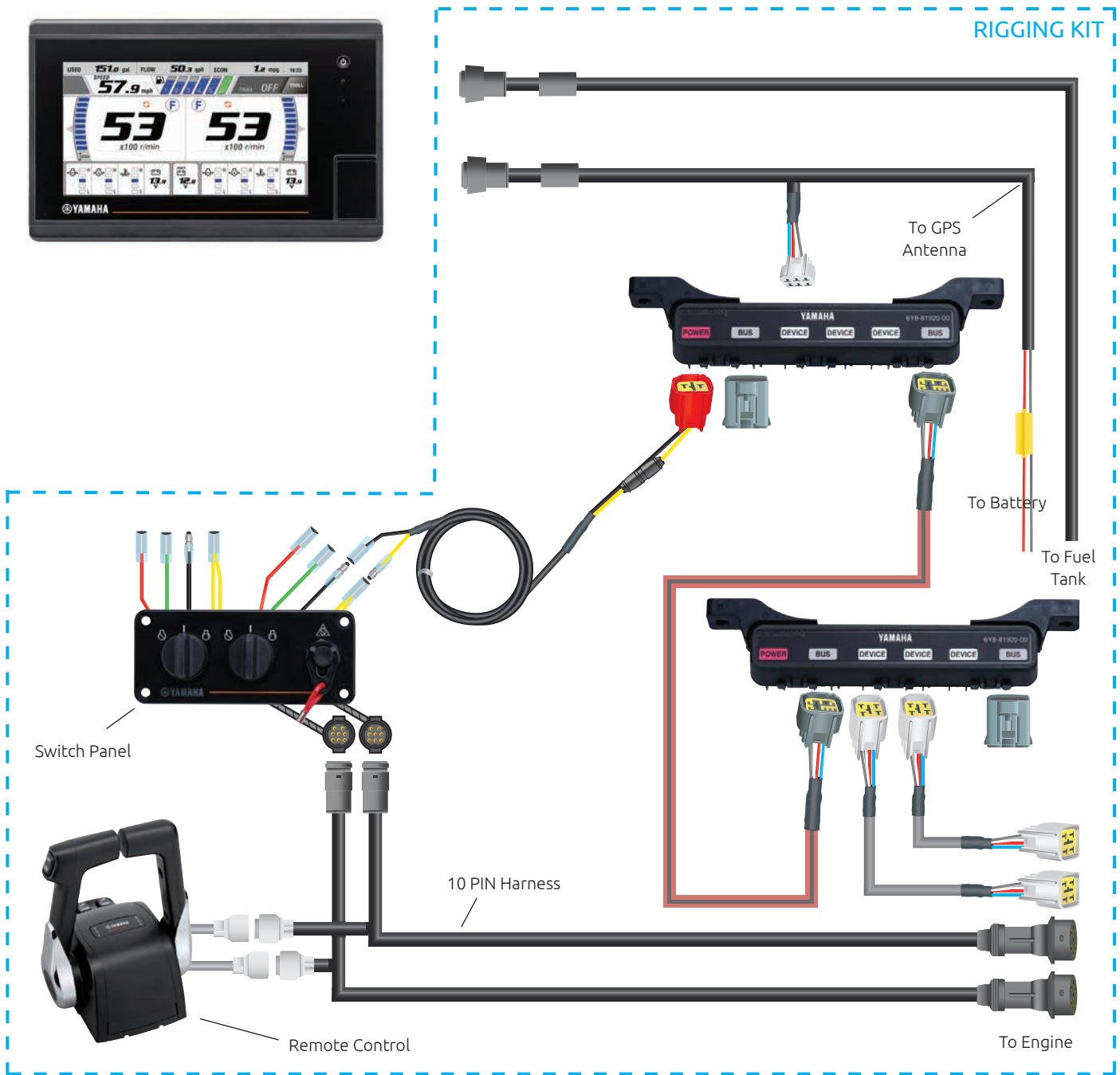

Part Number	Description	Qty	Price
RIGGING KIT			
6YD-83710-01-00	CL7 Display	1	
6YD-762R0-00-00	CL7 Counter Rotation Rigging Kit	1	

For Y-COP, Multi-sensor and Gateway installations please see page 85-90

DBW REMOTE CONTROL (MAIN STATION)

SINGLE ENGINE (6YC GAUGE + 6X7 FLUSH MOUNT)

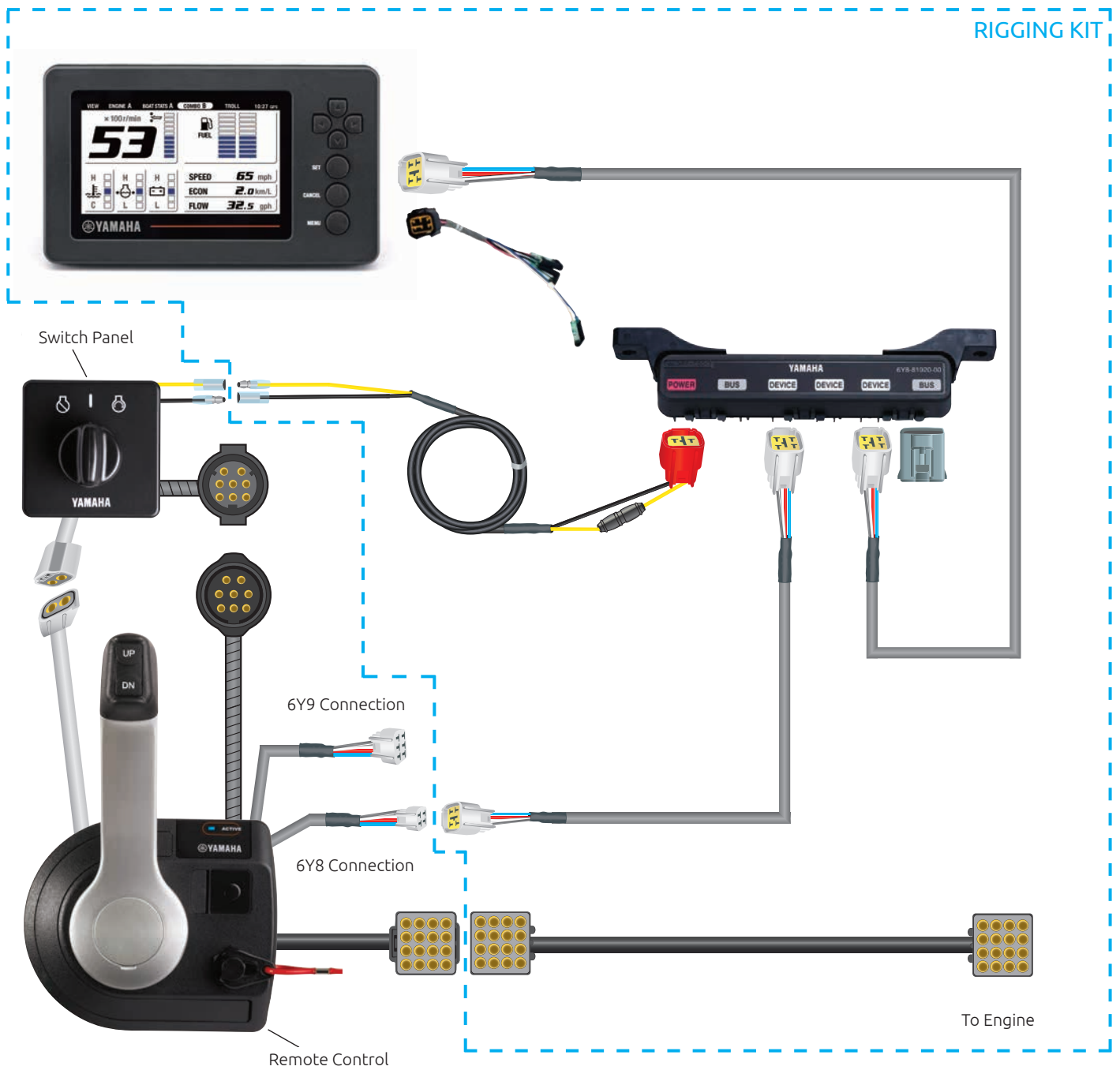

Part Number	Description	Qty	Price
RIGGING KIT			
6Y8-762G0-21-00	6YC Single Rigging Kit	1	
REMOTE CONTROL BOX AND SWITCH PANEL			
6X7-48206-21-00	6X7 Flush mount remote control	1	
64D-82570-22-00	Single Engine Key Switch	1	

Rigging Order Guide

DBW REMOTE CONTROL (MAIN STATION)

SINGLE ENGINE (6YC GAUGES + 6X6 TOP MOUNT)

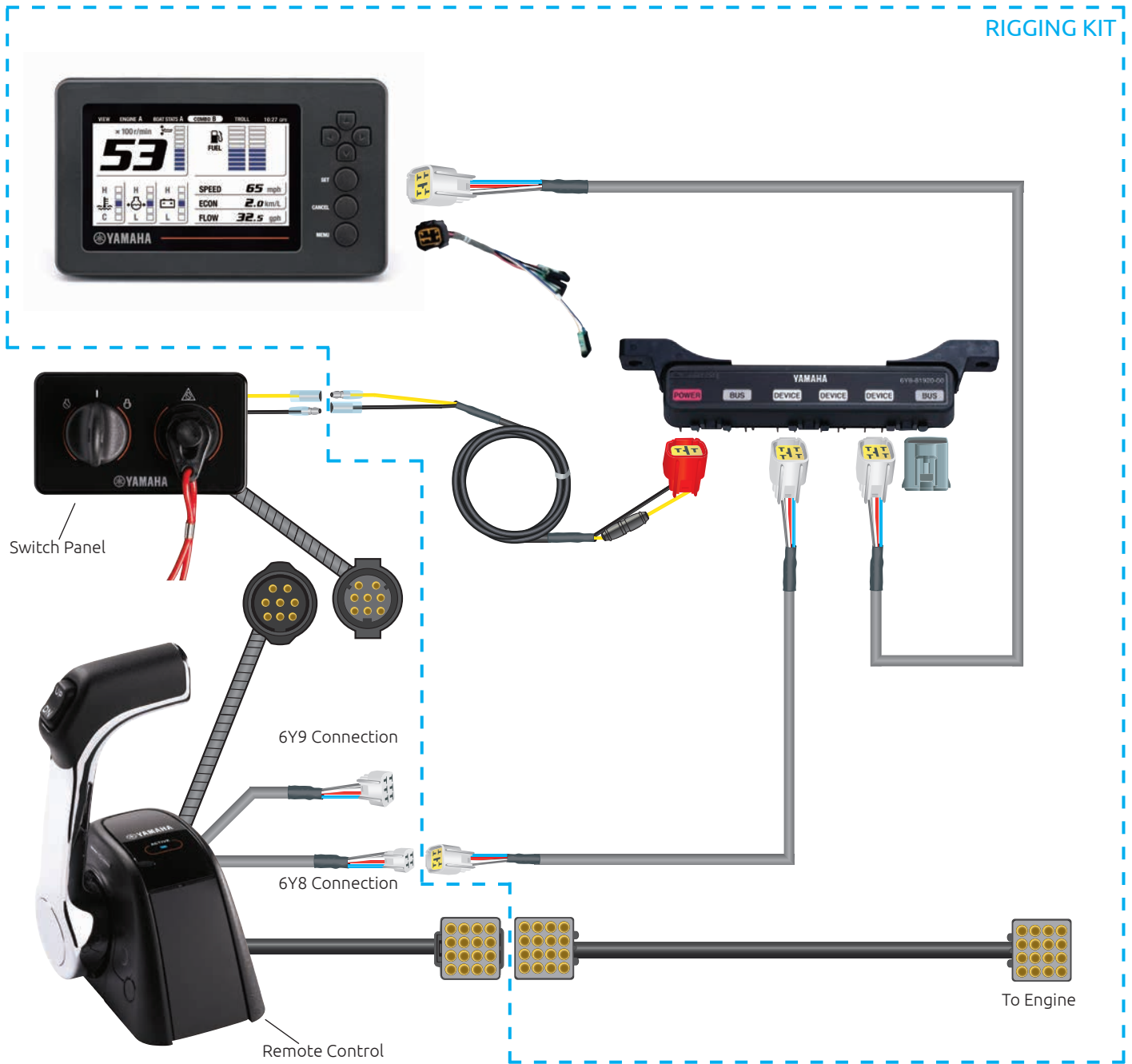

Part Number	Description	Qty	Price
RIGGING KIT			
6Y8-762G0-21-00	6YC LCD Single Kit	1	
REMOTE CONTROL BOX AND SWITCH PANEL			
6X6-48205-61-00	6X6 Top mount remote control	1	
6X6-48205-71-00	6X6 Top mount remote control * For dual stations	1	
6X6-82570-33-00	Single Engine Key Switch	1	

For Y-COP, Multi-sensor and Gateway installations please see page 85-90

SINGLE ENGINE (CL7 GAUGES + 6X7 FLUSH MOUNT)

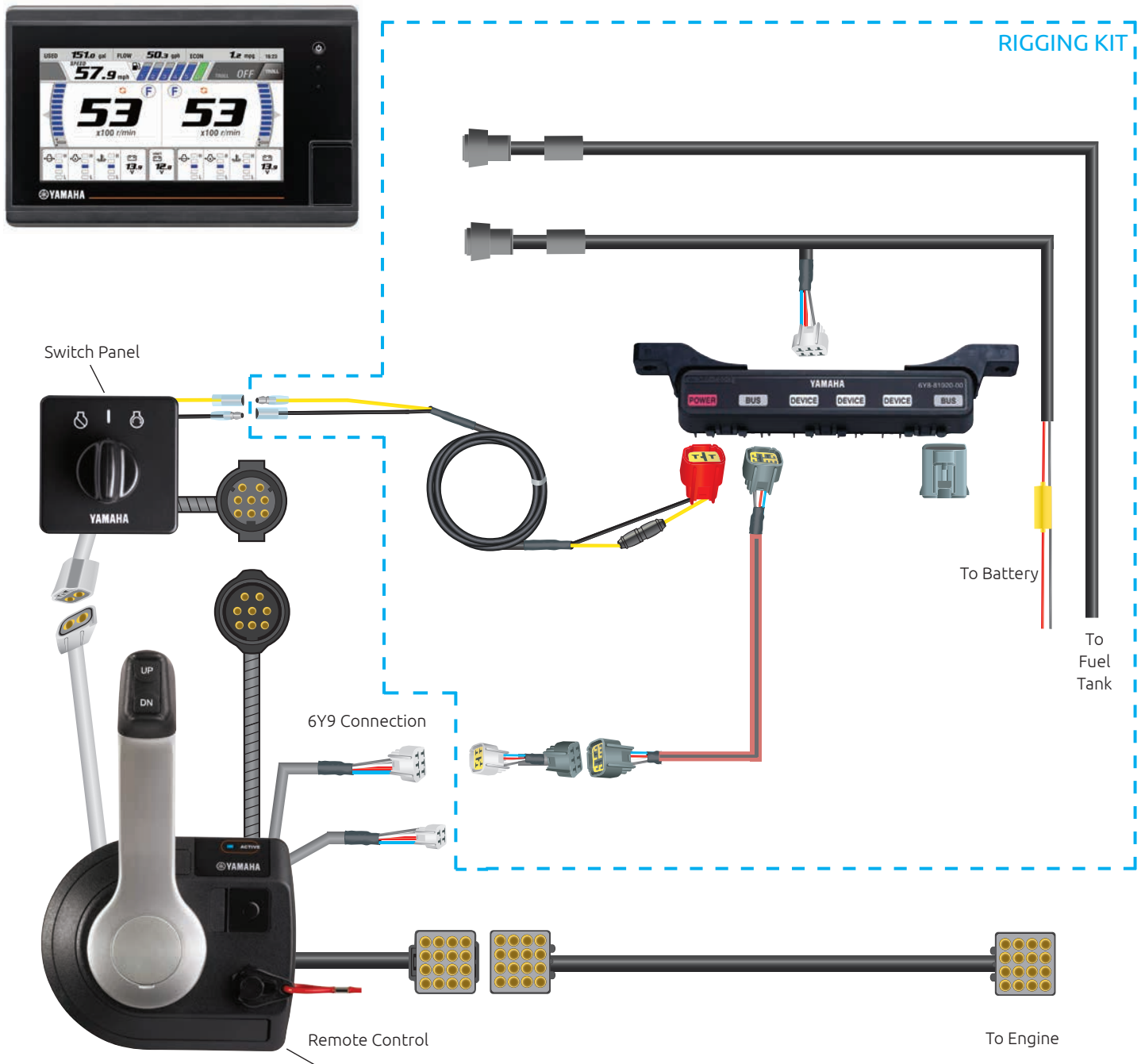

Part Number	Description	Qty	Price
RIGGING KIT			
6YD-762A0-00-00	CL7 Kit	1	
6YD-83710-01-00	CL7 Display	1	
REMOTE CONTROL BOX AND SWITCH PANEL			
6X7-48206-21-00	6X7 Flush mount remote control	1	
64D-82570-22-00	Single Engine Key Switch	1	
16-PIN MAIN HARNESS			
6X6-8258A-50-00	3.7 m (12 ft)		
6X6-8258A-60-00	5.2 m (17 ft)		
6X6-8258A-00-00	6 m (19 ft)		
6X6-8258A-10-00	7 m (23 ft)	1	
6X6-8258A-20-00	8 m (26 ft)		
6X6-8258A-30-00	10 m (32 ft)		
6X6-8258A-40-00	12 m (39 ft)		

For Y-COP, Multi-sensor and Gateway installations please see page 85-90

Rigging Order Guide

DBW REMOTE CONTROL (MAIN STATION)

SINGLE ENGINE (CL7 GAUGES + 6X6 TOP MOUNT)

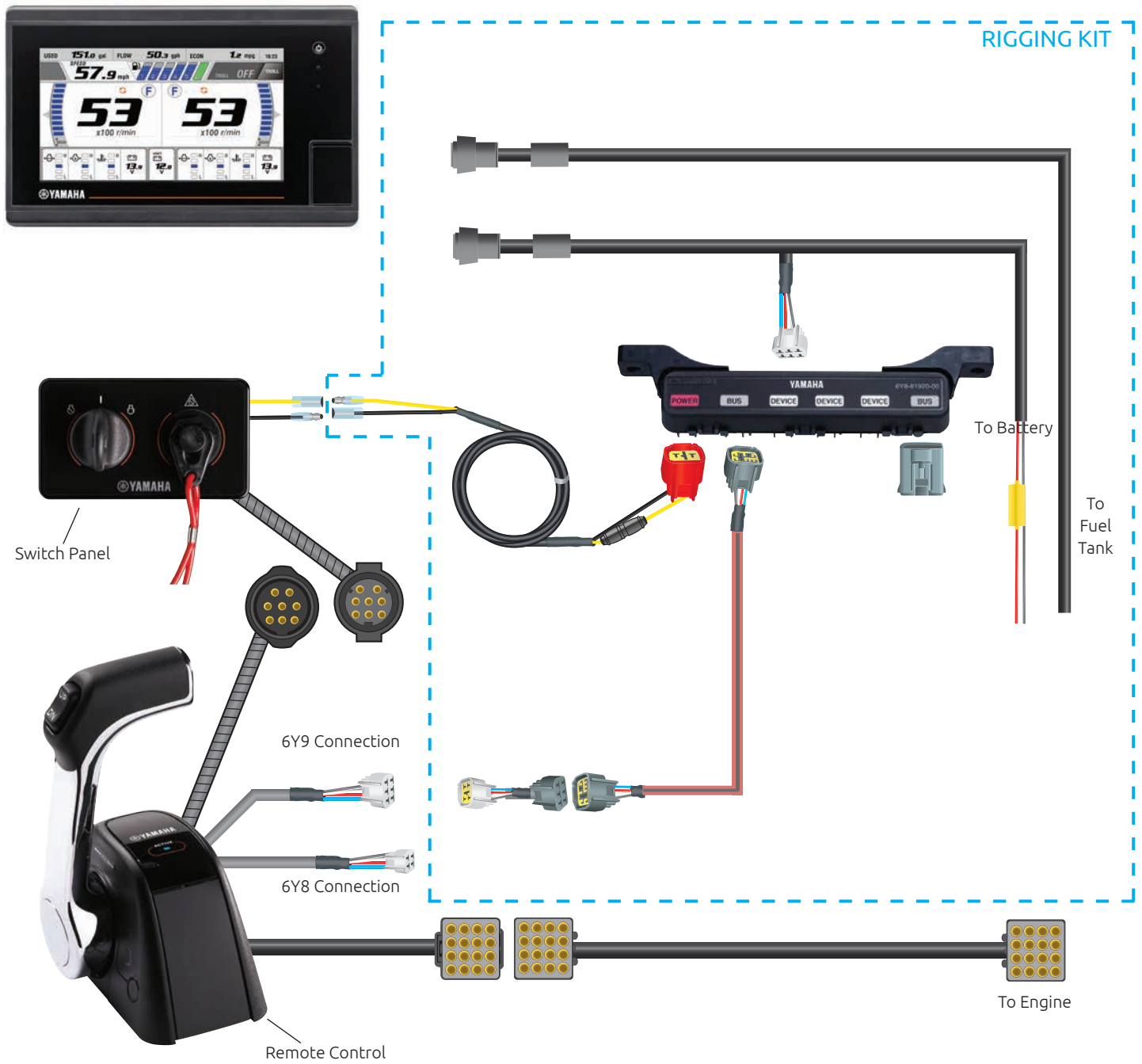

Part Number	Description	Qty	Price
RIGGING KIT			
6YD-762A0-00-00	CL7 Kit	1	
6YD-83710-01-00	CL7 Display	1	
REMOTE CONTROL BOX AND SWITCH PANEL			
6X6-48205-61-00	6X6 Top mount remote control	1	
6X6-82570-33-00	Switch Panel	1	
16-PIN MAIN HARNESS			
6X6-8258A-50-00	3.7 m (12 ft)		
6X6-8258A-60-00	5.2 m (17 ft)		
6X6-8258A-00-00	6 m (19 ft)		
6X6-8258A-10-00	7 m (23 ft)	1	
6X6-8258A-20-00	8 m (26 ft)		
6X6-8258A-30-00	10 m (32 ft)		
6X6-8258A-40-00	12 m (39 ft)		

For Y-COP, Multi-sensor and Gateway installations please see page 85-90

TWIN ENGINE (6YC GAUGE)

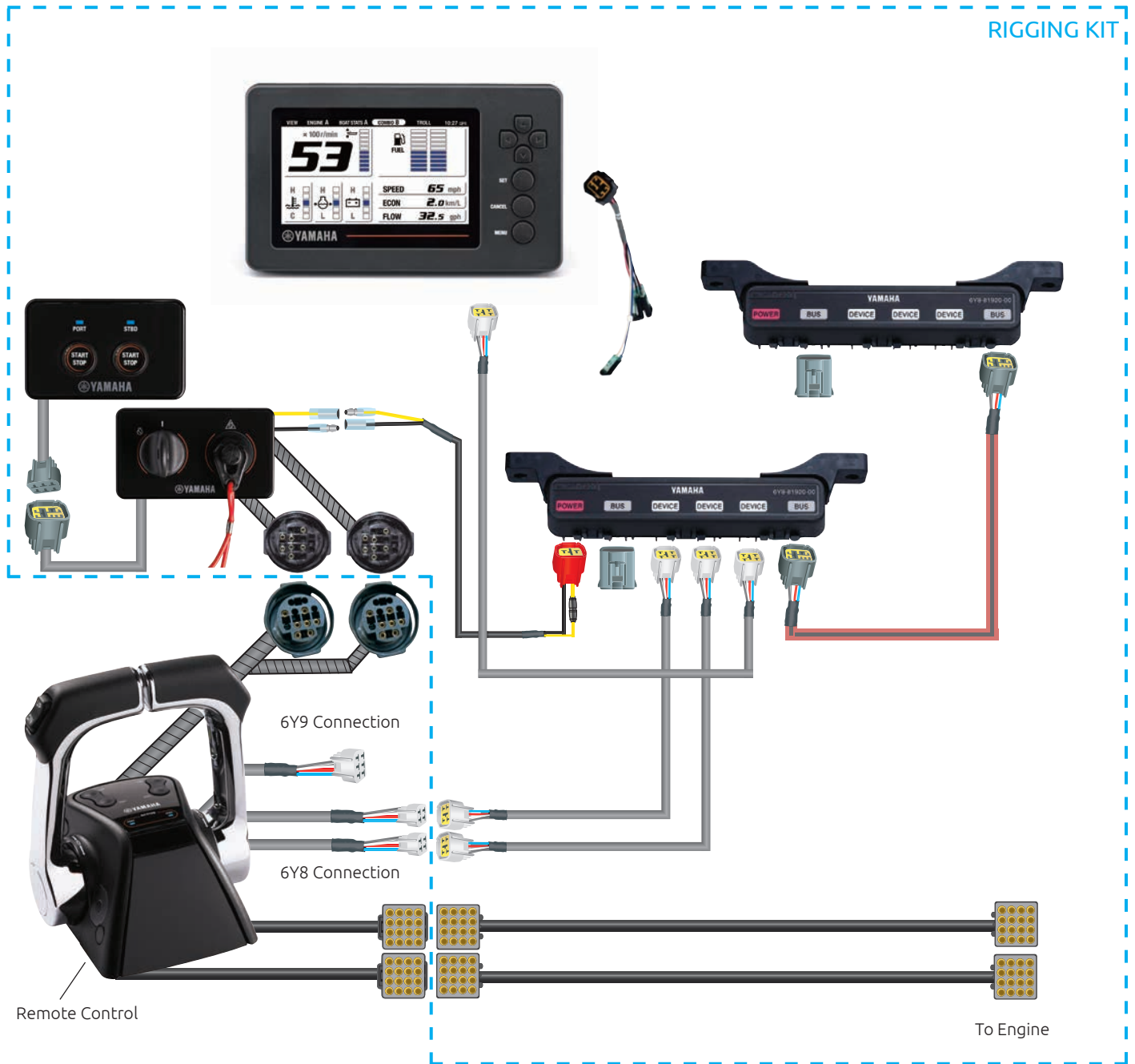

Part Number	Description	Qty	Price
RIGGING KIT			
6Y8-762G0-11-00	6YC Twin Rigging Kit	1	
REMOTE CONTROL BOX			
6X6-48207-37-00	6X6 Twin Engines Top mount control	1	
6X6-48207-70-00	6X6 Twin Engines Top mount control * For dual stations		

Rigging Order Guide

DBW REMOTE CONTROL (MAIN STATION)

TWIN ENGINE (6YC GAUGE)

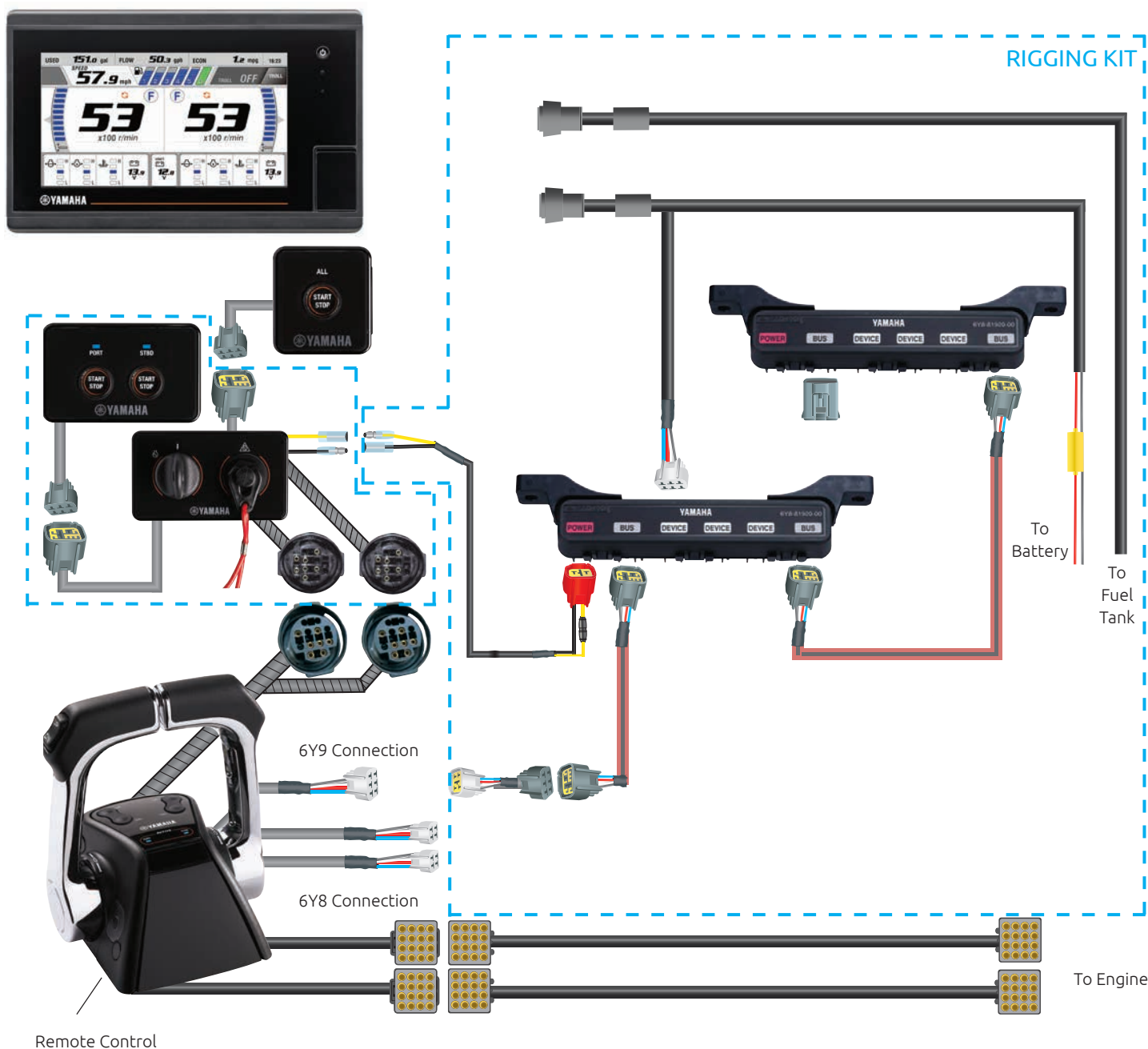

Part Number	Description	Qty	Price
RIGGING KIT			
6YD-762A0-00-00	CL7 Kit	1	
6YD-83710-01-00	CL7 Display	1	
REMOTE CONTROL BOX AND SWITCH PANEL			
6X6-48207-61-00	6X6 Top mount remote control	1	
6X6-82570-D0-00	All start switch (option)	1	
6X6-762B0-00-00	Main SW Kit	1	
16-PIN MAIN HARNESS			
6X6-8258A-50-00	3.7 m (12 ft)		
6X6-8258A-60-00	5.2 m (17 ft)		
6X6-8258A-00-00	6 m (19 ft)		
6X6-8258A-10-00	7 m (23 ft)		
6X6-8258A-20-00	8 m (26 ft)		
6X6-8258A-30-00	10 m (32 ft)	1	
6X6-8258A-40-00	12 m (39 ft)		

For Y-COP, Multi-sensor and Gateway installations please see page 85-90

TRIPLE ENGINE (CL7 GAUGE)

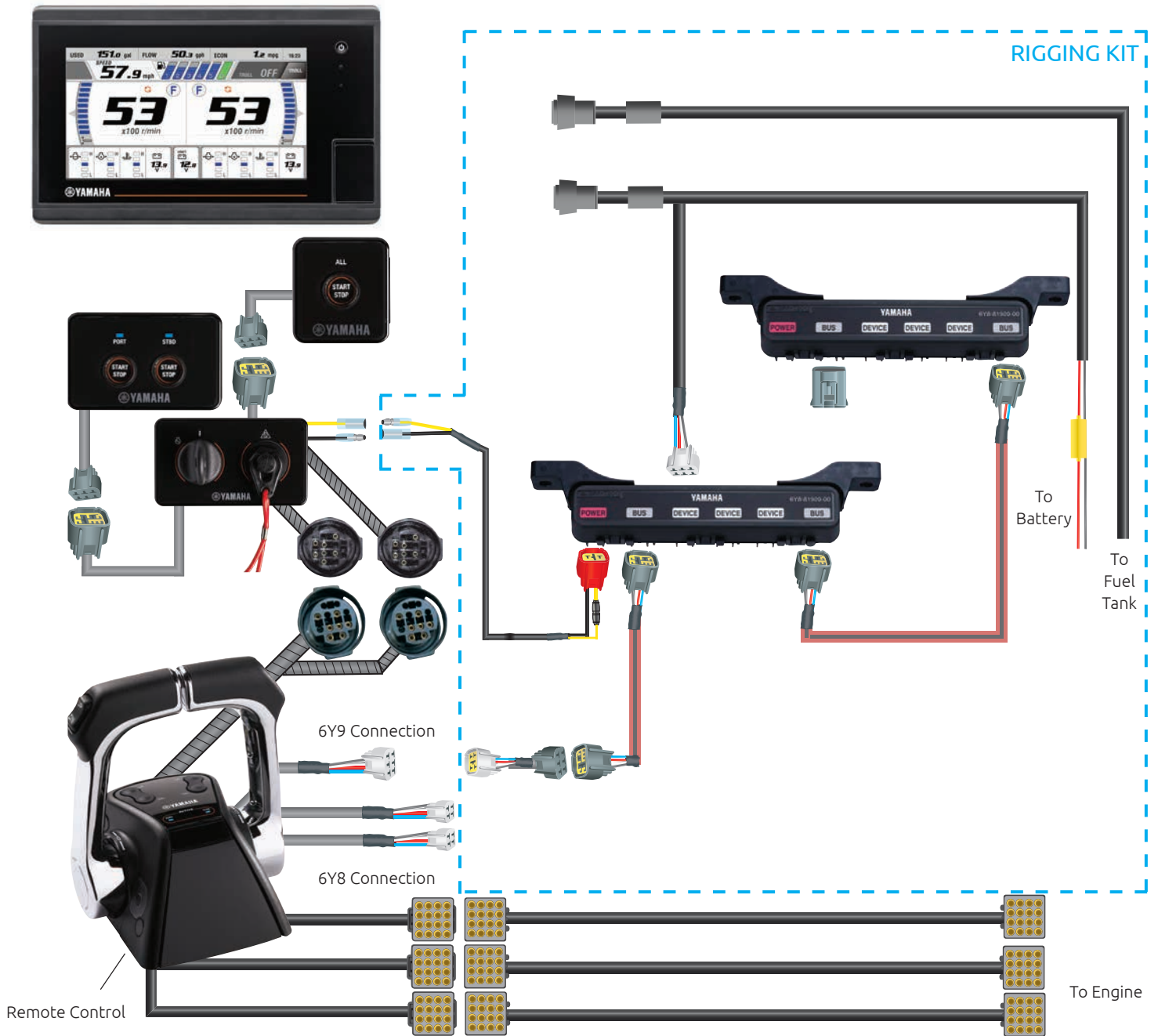

Part Number	Description	Qty	Price
RIGGING KIT			
6YD-762A0-00-00	CL7 Kit	1	
6YD-83710-01-00	CL7 Display	1	
REMOTE CONTROL BOX AND SWITCH PANEL			
6X6-48207-61-00	6X6 Top mount remote control	1	
6X6-82570-D0-00	Switch Panel	1	
6X6-762B0-00-00	Main SW Kit	1	
16-PIN MAIN HARNESS			
6X6-8258A-50-00	3.7 m (12 ft)		
6X6-8258A-60-00	5.2 m (17 ft)		
6X6-8258A-00-00	6 m (19 ft)		
6X6-8258A-10-00	7 m (23 ft)		
6X6-8258A-20-00	8 m (26 ft)		
6X6-8258A-30-00	10 m (32 ft)	1	
6X6-8258A-40-00	12 m (39 ft)		

For Y-COP, Multi-sensor and Gateway installations please see page 85-90

Rigging Order Guide

DBW REMOTE CONTROL (2ND STATION)

SINGLE ENGINE (FLUSH MOUNT)

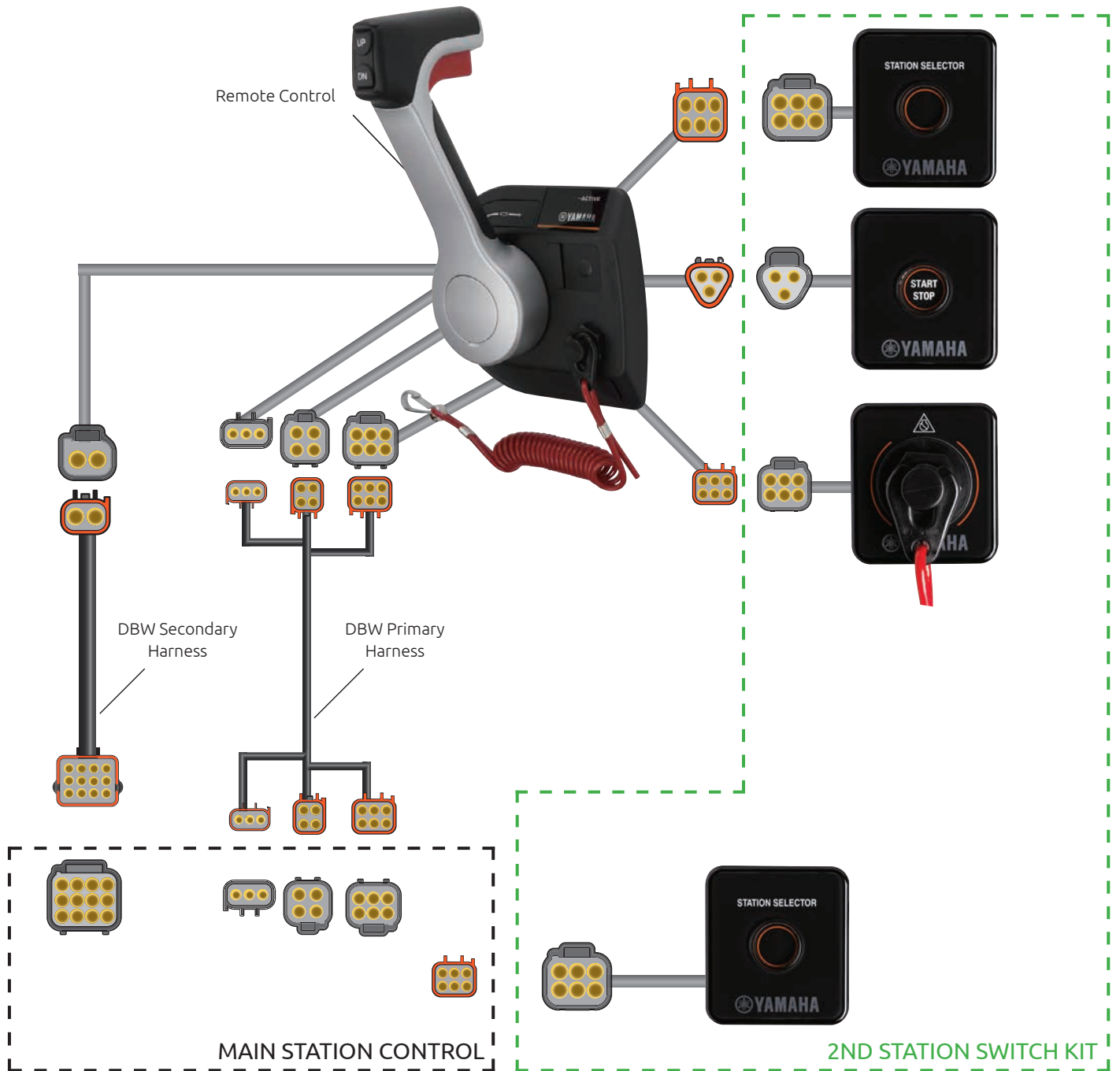

Part Number	Length/Description	Qty	Price
DBW PRIMARY HARNESS (3-4-6 PIN)			
6X6-8258A-G1-00	5 m (16 ft)		
6X6-8258A-H1-00	8 m (26 ft)	1	
6X6-8258A-J1-00	12 m (38 ft)		
DBW SECONDARY HARNESS (2-12 PIN)			
6X6-8258A-B1-00	5 m (16 ft)		
6X6-8258A-D1-00	8 m (26 ft)	1	
6X6-8258A-F1-00	12 m (38 ft)		
REMOTE CONTROL BOX AND SWITCH PANEL			
6X7-48206-40-00	6X7 Flush mount remote control * For sub (2nd) station	1	
6X6-W0035-70-00	Single engine Second Station Switch Kit	1	

For Y-COP, Multi-sensor and Gateway installations please see page 85-90

SINGLE ENGINE (TOP MOUNT)

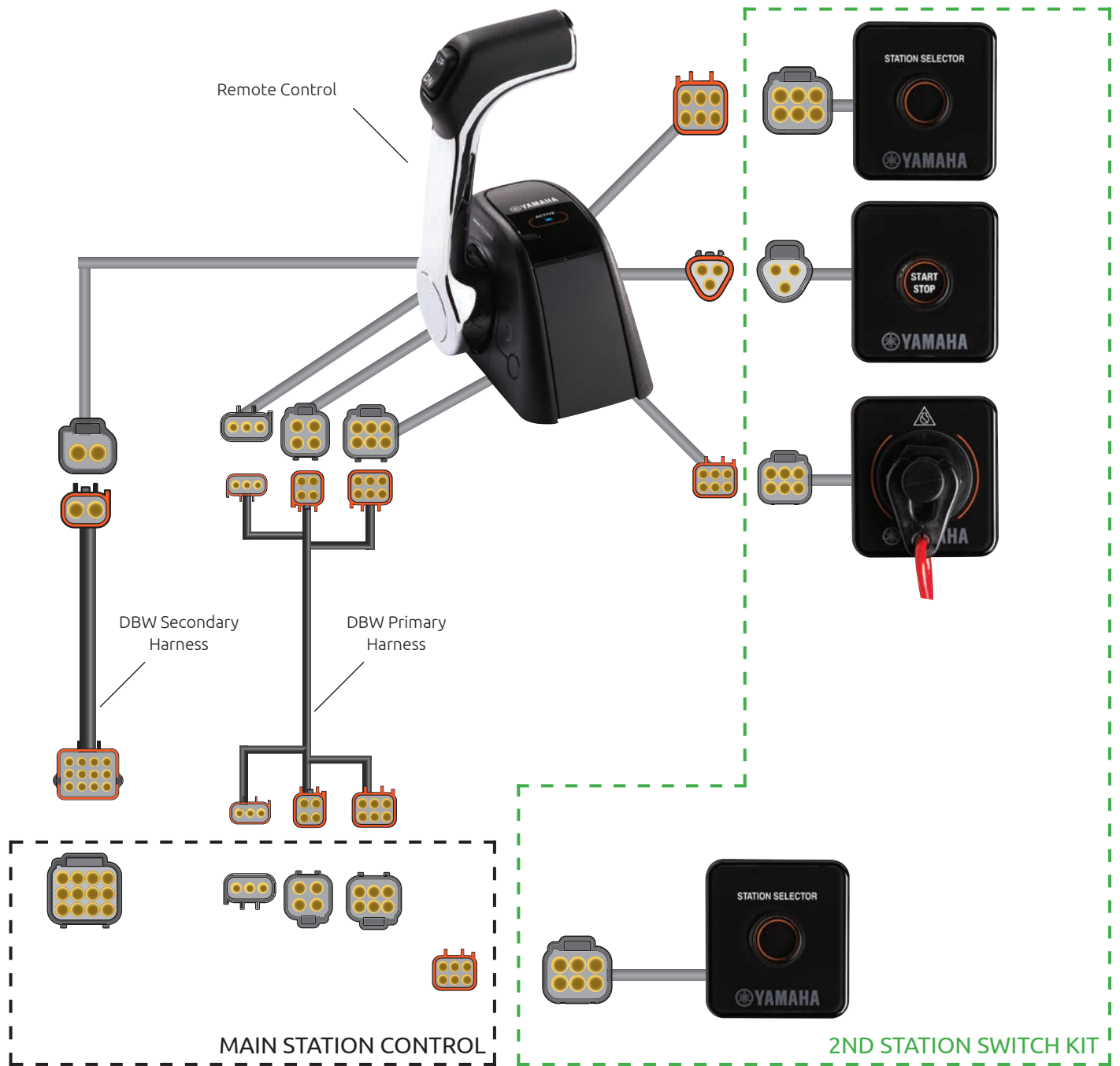

Part Number	Length/Description	Qty	Price
DBW PRIMARY HARNESS (3-4-6 PIN)			
6X6-8258A-G1-00	5 m (16 ft)		
6X6-8258A-H1-00	8 m (26 ft)	1	
6X6-8258A-J1-00	12 m (38 ft)		
DBW SECONDARY HARNESS (2-12 PIN)			
6X6-8258A-B1-00	5 m (16 ft)		
6X6-8258A-D1-00	8 m (26 ft)	1	
6X6-8258A-F1-00	12 m (38 ft)		
REMOTE CONTROL BOX AND SWITCH PANEL			
6X6-48205-56-00	6X6 Top mount remote control * For sub (2nd) station	1	
6X6-W0035-70-00	Single engine Second Station Switch Kit	1	

For Y-COP, Multi-sensor and Gateway installations please see page 85-90

Rigging Order Guide

DBW REMOTE CONTROL (2ND STATION)

TWIN ENGINE

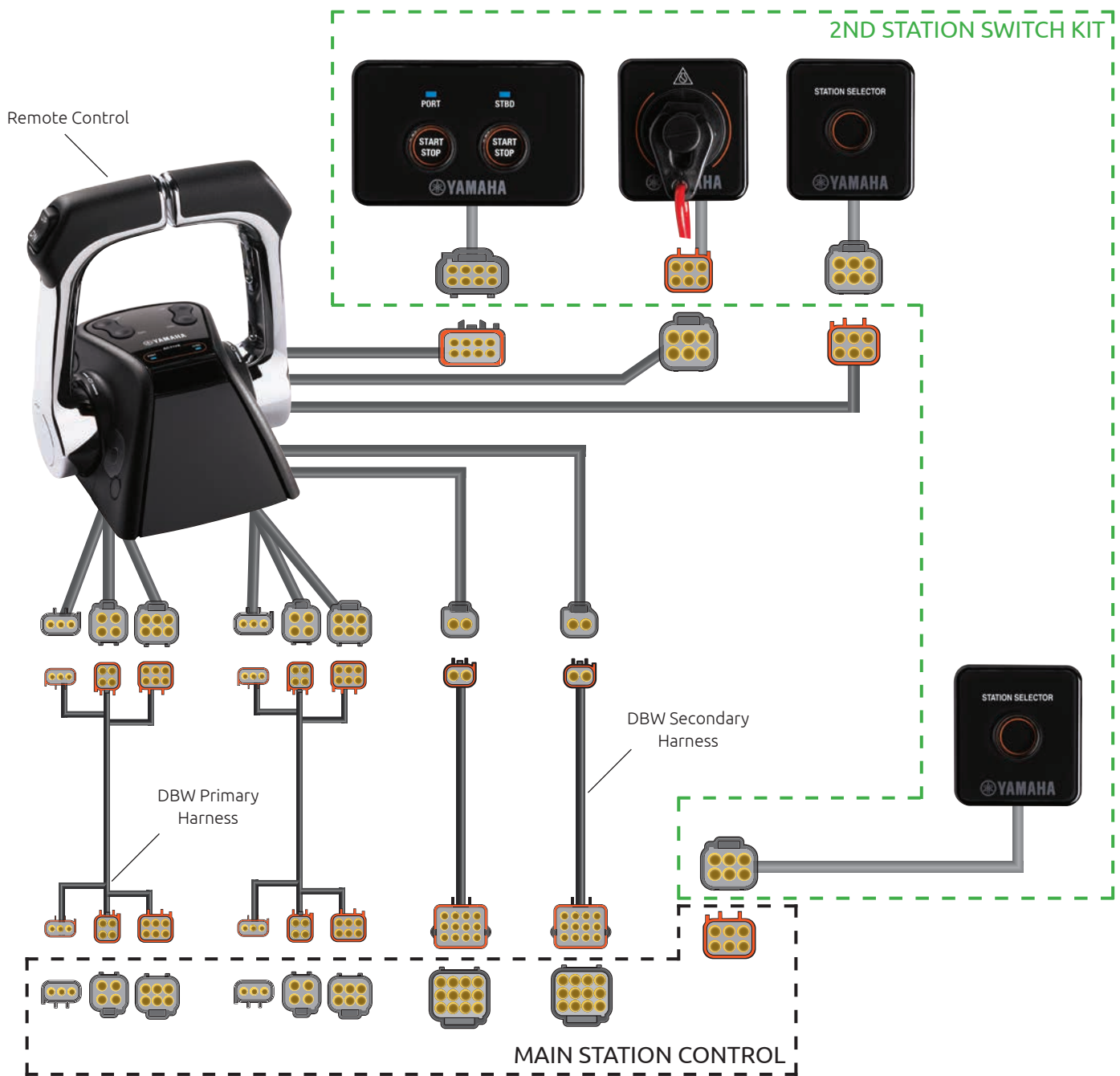

Part Number	Length/Description	Qty	Price
DBW PRIMARY HARNESS (3-4-6 PIN)			
6X6-8258A-G1-00	5 m (16 ft)		
6X6-8258A-H1-00	8 m (26 ft)	1	
6X6-8258A-J1-00	12 m (38 ft)		
DBW SECONDARY HARNESS (2-12 PIN)			
6X6-8258A-B1-00	5 m (16 ft)		
6X6-8258A-D1-00	8 m (26 ft)	1	
6X6-8258A-F1-00	12 m (38 ft)		
REMOTE CONTROL BOX AND SWITCH PANEL			
6X6-48207-56-00	6X6 Twin Engine Top mount remote control * For sub (2nd) station	1	
6X6-W0035-80-00	Twin engines Second Station Switch Kit	1	

For Y-COP, Multi-sensor and Gateway installations please see page 85-90

TRIPLE ENGINE

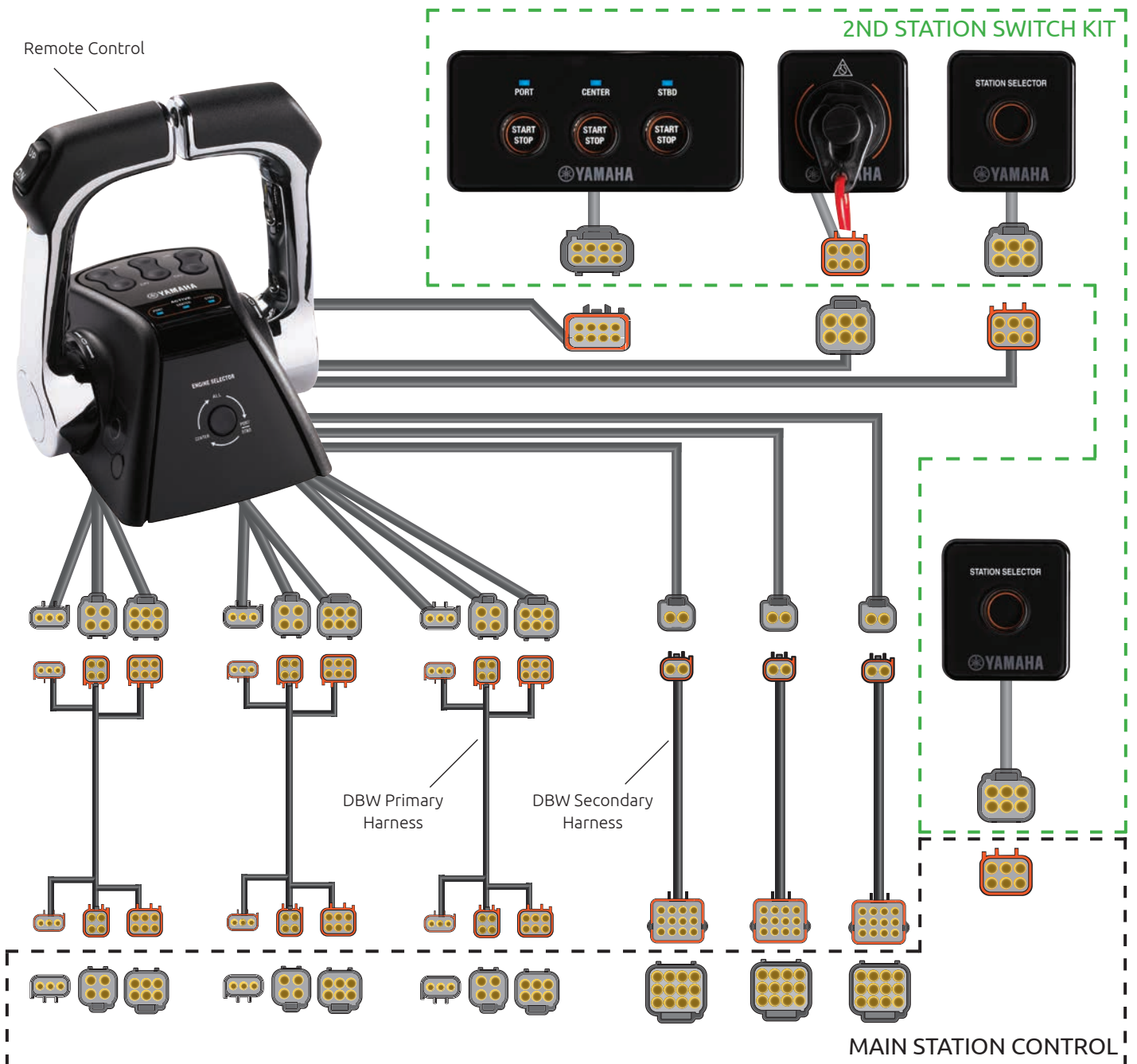

Part Number	Length/Description	Qty	Price
DBW PRIMARY HARNESS (3-4-6 PIN)			
6X6-8258A-G1-00	5 m (16 ft)		
6X6-8258A-H1-00	8 m (26 ft)	1	
6X6-8258A-J1-00	12 m (38 ft)		
DBW SECONDARY HARNESS (2-12 PIN)			
6X6-8258A-B1-00	5 m (16 ft)		
6X6-8258A-D1-00	8 m (26 ft)	1	
6X6-8258A-F1-00	12 m (38 ft)		
REMOTE CONTROL BOX AND SWITCH PANEL			
6X6-48208-53-00	6X6 Triple Engine Top mount control * For sub (2nd) station	1	
6X6-W0035-90-00	Triple engines Second Station Switch Kit	1	

For Y-COP, Multi-sensor and Gateway installations please see page 85-90

Rigging Order Guide

XTO CONNECTION

SCU HARNESS (FOR TWIN XTO ENGINES)

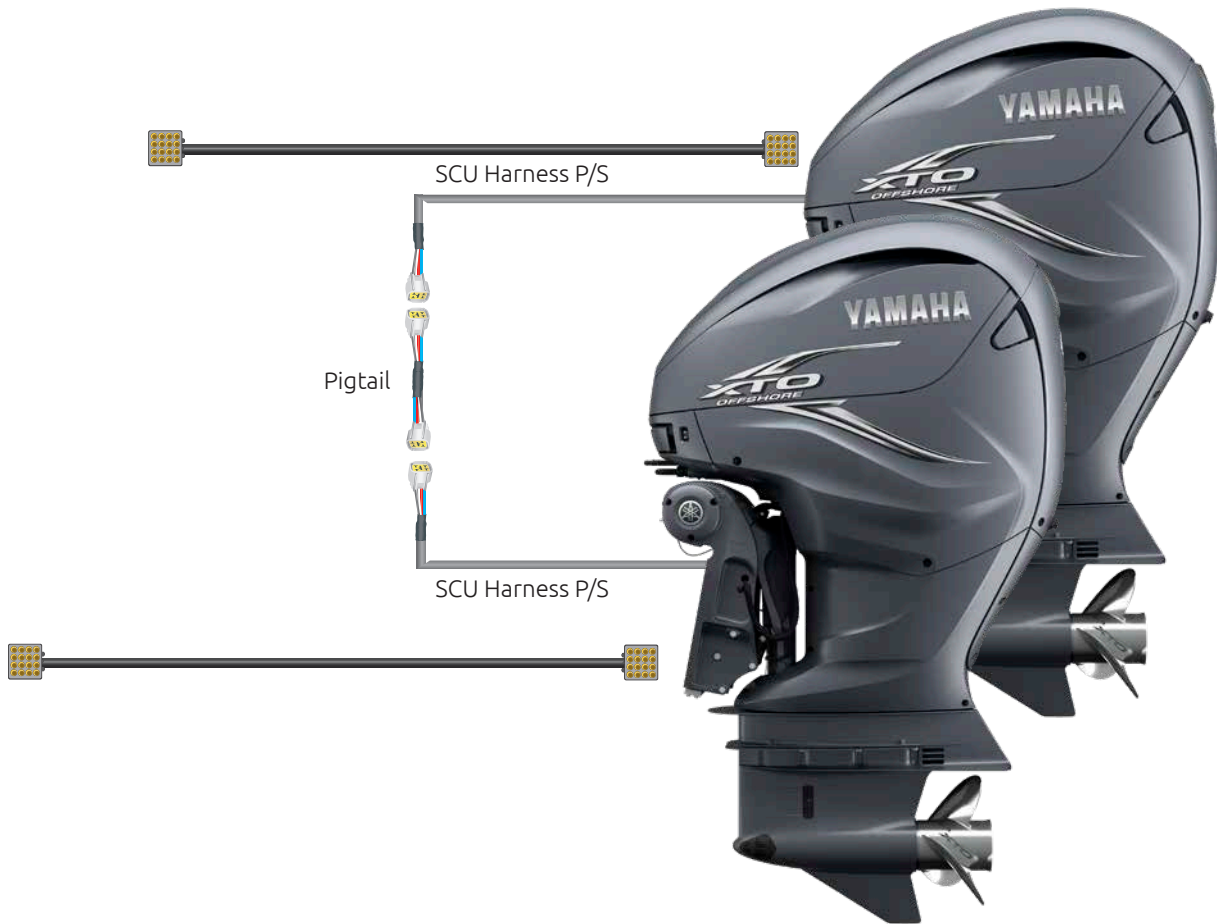

Part Number	Length/Description	Qty	Price
SCU LINK HARNESS (PORT/ STBD)			
6GR-81115-00	1.5 m (5 ft)	2	
6GR-81115-10	3.0 m (10 ft)		
PIGTAIL BUS WIRE			
6Y8-82521-01	0.3 m (1 ft)	1	
6Y8-82521-11	0.6 m (2 ft)		
6Y8-82521-21	0.9 m (3 ft)		
6Y8-82521-31	1.8 m (6 ft)		
6Y8-82521-41	2.7 m (9 ft)		
6Y8-82521-51	3.6 m (12 ft)		

For Y-COP, Multi-sensor and Gateway installations please see page 85-90

SCU HARNESS (FOR TRIPLE XTO ENGINES)

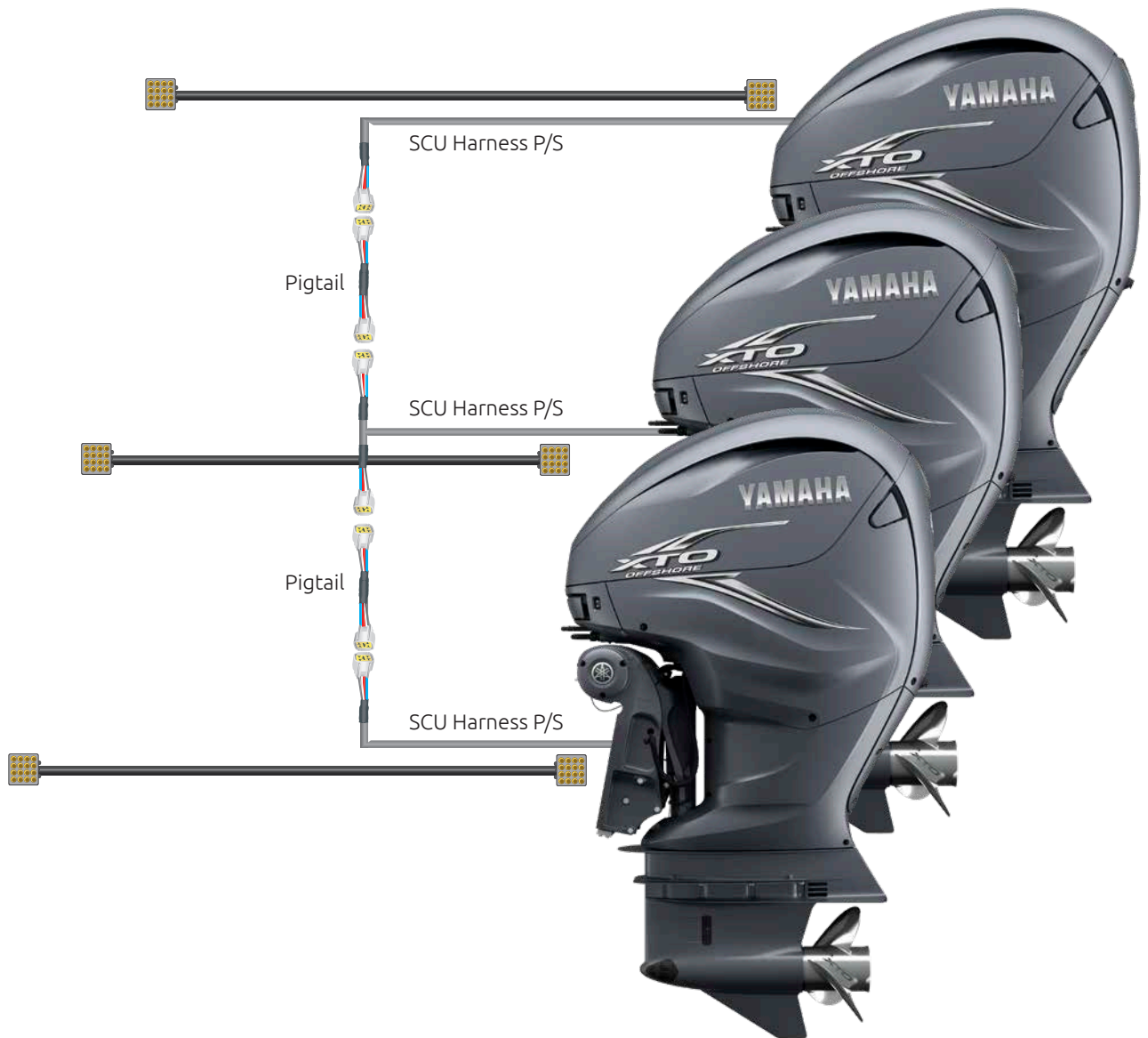

Part Number	Length/Description	Qty	Price
SCU LINK HARNESS (PORT/ STBD)			
6GR-81115-00	1.5 m (5 ft)	2	
6GR-81115-10	3.0 m (10 ft)		
SCU LINK HARNESS (CENTER)			
6GR-81115-20	1.5 m (5 ft)	1	
6GR-81115-30	3.0 m (10 ft)		
PIGTAIL BUS WIRE			
6Y8-82521-01	0.3 m (1 ft)	1	
6Y8-82521-11	0.6 m (2 ft)		
6Y8-82521-21	0.9 m (3 ft)		
6Y8-82521-31	1.8 m (6 ft)		
6Y8-82521-41	2.7 m (9 ft)		
6Y8-82521-51	3.6 m (12 ft)		

For Y-COP, Multi-sensor and Gateway installations please see page 85-90



 **YAMAHA**

8

four stroke

<p>⚠️ WARNING</p> <p>Read Owner's Manual and labels. When an approved personal flotation device (PFD) which meets out-of-craft standard is your PFD, and, at all times the engine stops if you accidentally release the throttle, which could prevent a runaway boat.</p>	<p>⚠️ AVERTISSEMENT</p> <p>Lisez le Manuel de l'utilisateur et les étiquettes. Portez un gilet de sauvetage homologué. Attachez le capteur à votre PFD si votre gilet de sauvetage, à votre titre, n'a à votre avis pour que le moteur s'arrête si vous relâchez accidentellement la barre. Cela permet d'éviter que le bateau ne poursuive sa route sans contrôle.</p>
---	--

YAMAHA
650000

MULTI-SENSOR

FOR 6Y9 COLOUR DISPLAY

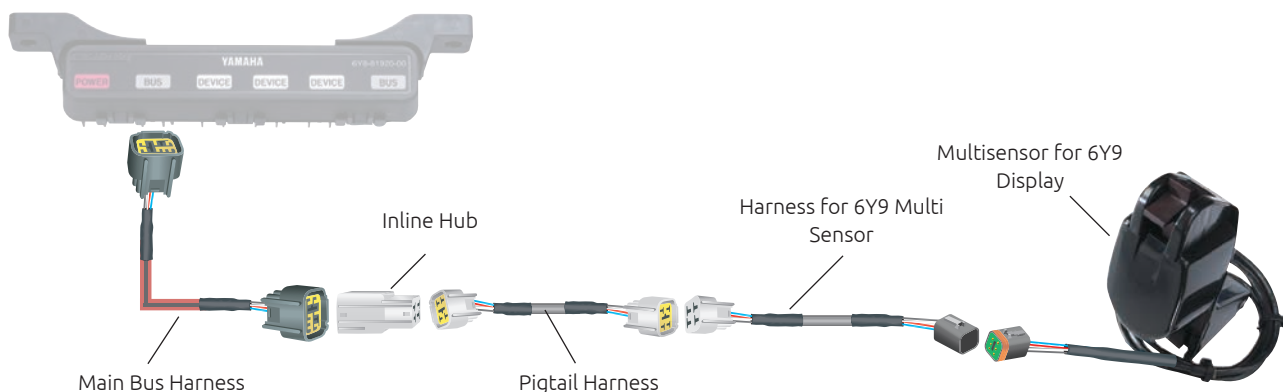

MULTI-SENSOR, HUB AND CONVERSION HARNESSSES

PART NUMBER	DESCRIPTION	QTY	PRICE
6Y9-83688-00-00	Multisensor for 6Y9 Display	1	
6Y8-81920-11-00	Inline Hub	1	
6Y9-83553-60-00	Harness for 6Y9 Multi Sensor	1	

MAIN BUS HARNESS (6-PIN)

PART NUMBER	LENGTH	PRICE
6Y8-82553-41-00	9.1 m (30 ft)	
6Y8-82553-31-00	7.6 m (25 ft)	
6Y8-82553-21-00	6.1 m (20 ft)	
6Y8-82553-11-00	4.6 m (15 ft)	
6Y8-82553-50-00	3.0 m (10 ft)	
6Y8-82553-01-00	0.3 m (1 ft)	

PIGTAIL BUS HARNESS (4-PIN)

PART NUMBER	LENGTH	PRICE
6Y8-82521-51-00	3.6 m (12 ft)	
6Y8-82521-41-00	2.7 m (9 ft)	
6Y8-82521-31-00	1.8 m (6 ft)	
6Y8-82521-21-00	0.9 m (3 ft)	
6Y8-82521-11-00	0.6 m (2 ft)	
6Y8-82521-01-00	0.3 m (1 ft)	

Rigging Order Guide

GATEWAY/AGI

GATEWAY

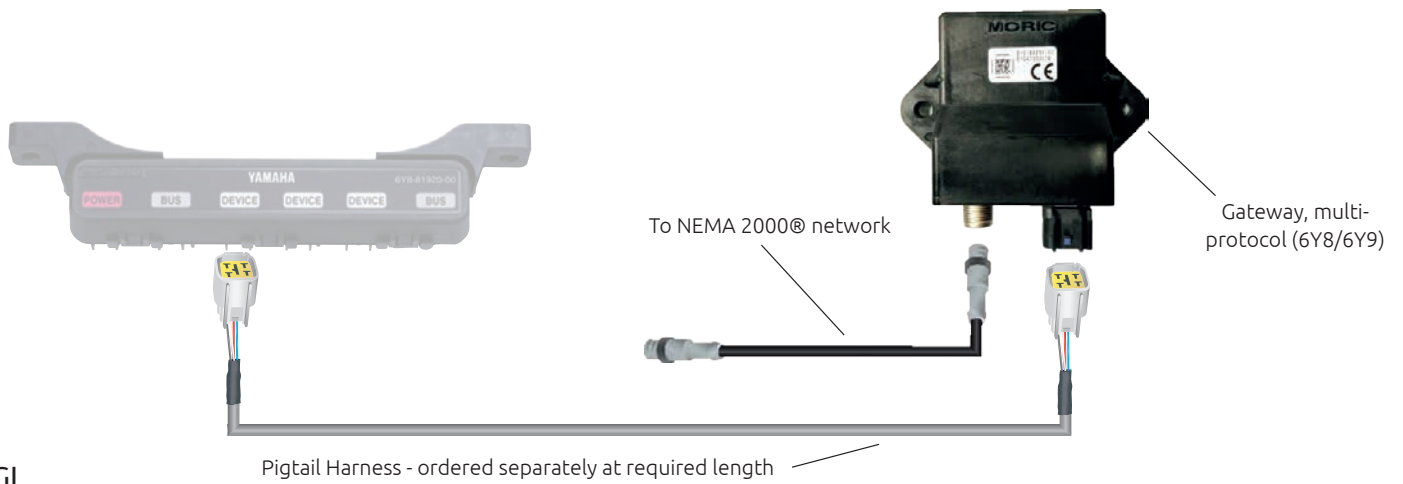

AGI

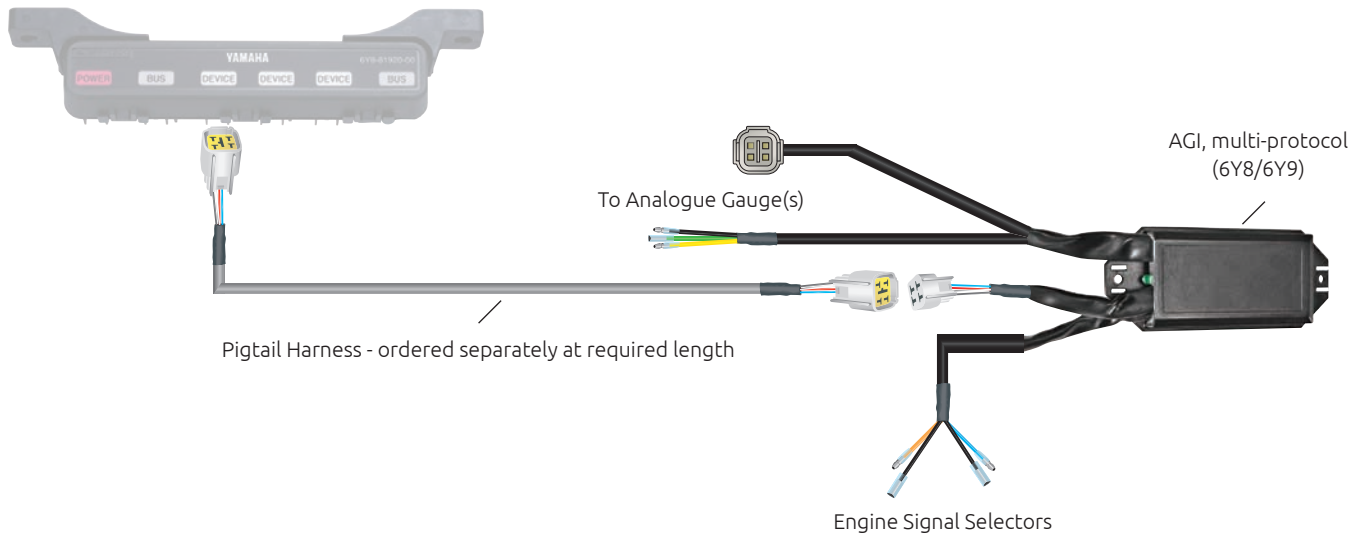

GATEWAY AND ANALOGUE GAUGE INTERFACE

PART NUMBER	DESCRIPTION	QTY	PRICE
6YG-82521-00-00	Gateway, multi-protocol (6Y8/6Y9), wire, lead	1	
6YG-8A2D0-00-00	Gateway, multi-protocol (6Y8/6Y9), interface	1	
6Y9-8A2D0-30-00	AGI, multi-protocol (6Y8/6Y9)	1	



Y-COP WITH 6X4 MULTI-FUNCTION TILLER HANDLE

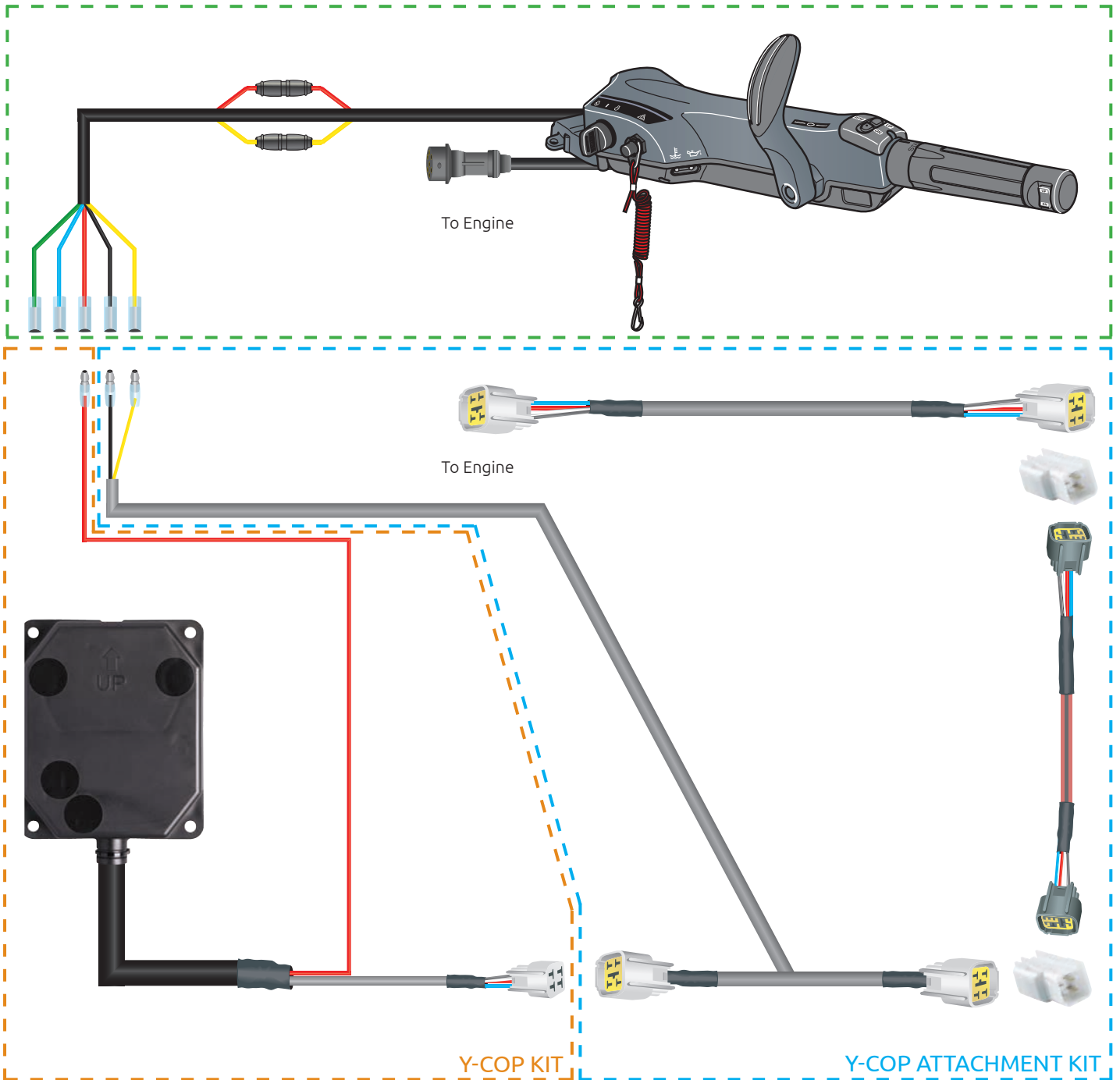

Part Number	Description	Qty	Price
Y-COP			
6Y8-W0035-J2-00	Y-COP Kit	1	
Y-COP ATTACHMENT KIT			
6Y8-762A0-00-00	Y-COP Attachment Kit (required for Y-COP + 6X4 handle installation)	1	
ENGINE GROMMET FOR Y-COP HARNESS*			
6C5-42725-50-00	F50H/FT50J/F50F/FT60G	1	
68V-42725-20-00	F80B/F100D/F115A	1	

*Required for Y-COP + 6X4 Tiller Handle installations on the specific engine models listed above.

Rigging Order Guide

Y-COP WITH SINGLE ENGINE

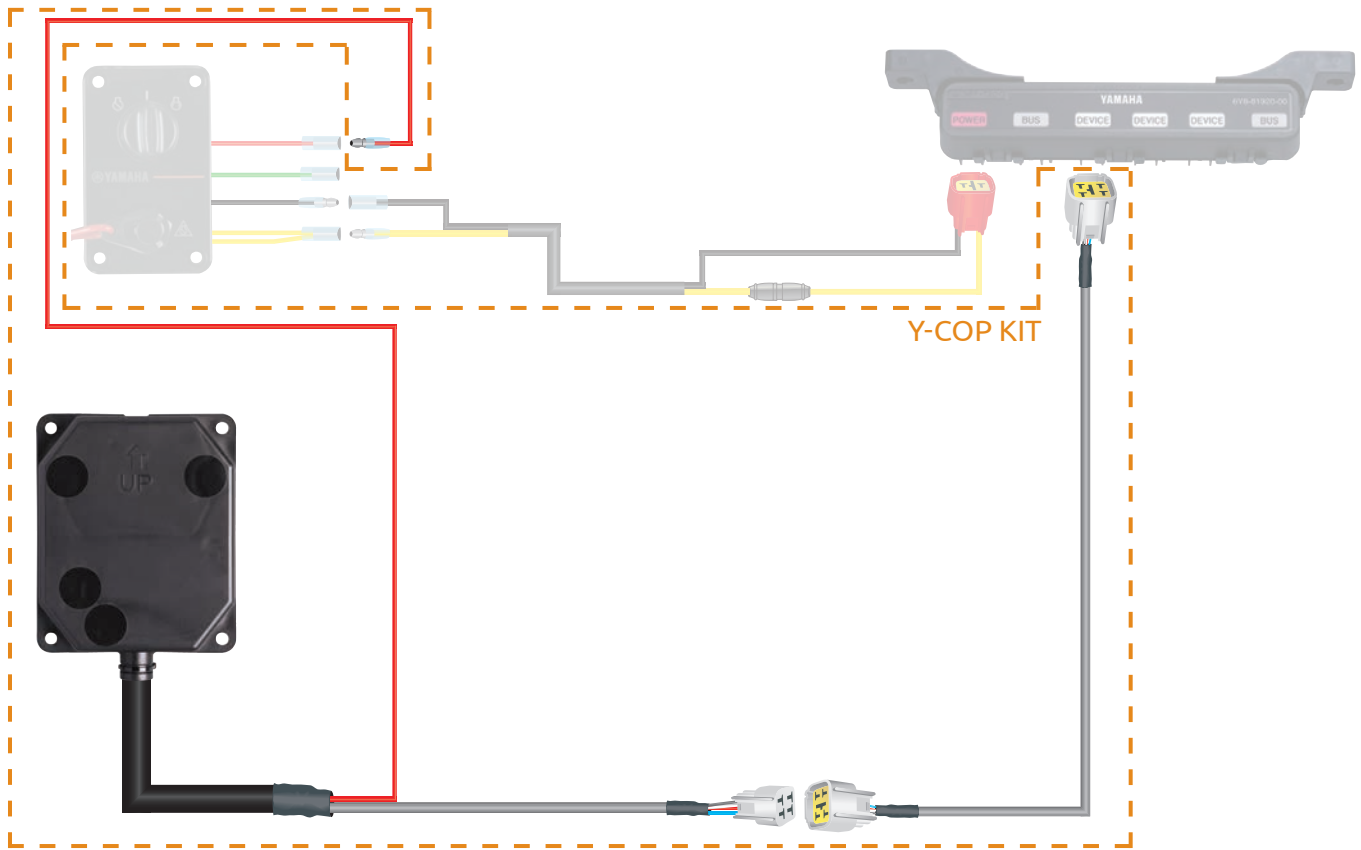

Part Number	Description	Qty	Price
Y-COP			
6Y8-W0035-J2-00	Y-COP Kit	1	

Y-COP WITH MULTIPLE ENGINES (MECHANICAL REMOTE CONTROL)

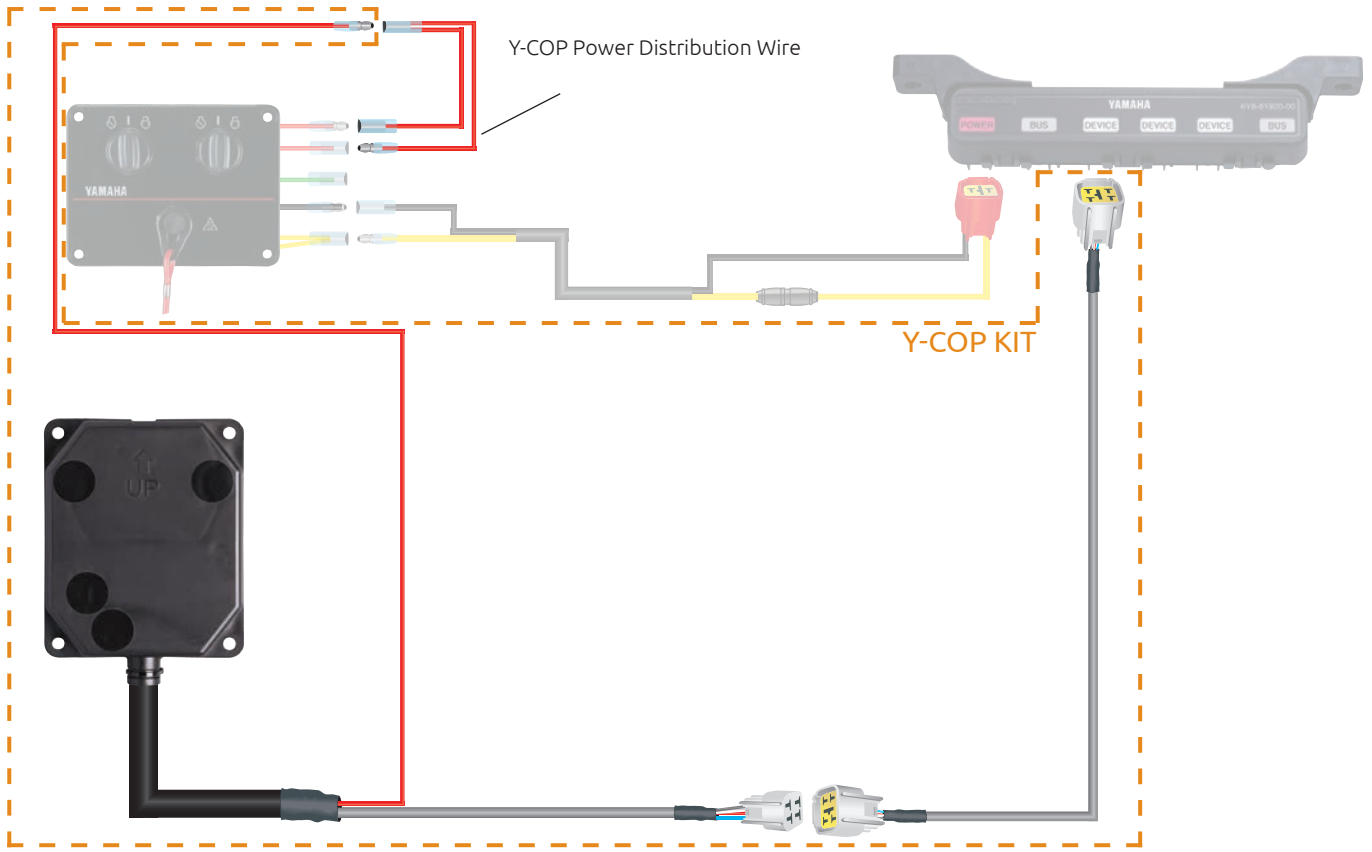

Part Number	Description	Qty	Price
Y-COP			
6Y8-W0035-J2-00	Y-COP Kit	1	
6H5-81315-00-00	Y-COP Power Distribution Wire (for multiple engines / Mechanical control)	1	

Rigging Order Guide

Y-COP WITH MULTIPLE ENGINES (DBW REMOTE CONTROL)

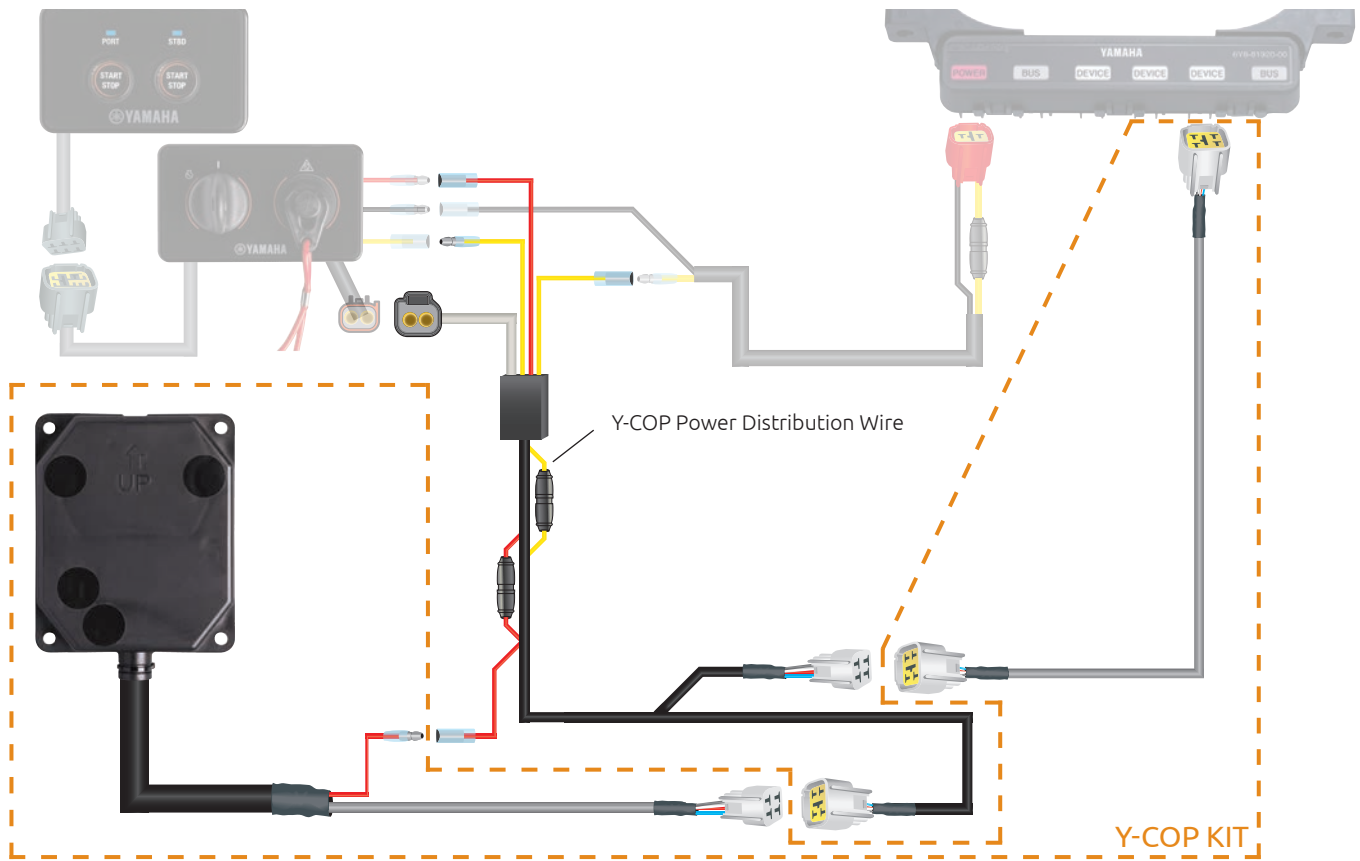

Part Number	Description	Qty	Price
Y-COP			
6Y8-W0035-J2-00	Y-COP Kit	1	
6Y8-81315-01-00	Y-COP Power Distribution Wire (for multiple engines / DBW control)	1	

Yamalube lubricants and Careline marine products

FOR THE SMOOTH, LONG TERM RELIABILITY OF YOUR YAMAHA, THERE'S SIMPLY NOTHING BETTER!

Yamalube marine lubricants are specifically formulated for Yamaha outboard engines and personal watercraft - and tested to levels they would never normally experience in the hands of an owner. The result is a smoother, more confident ride every time you hit the water.

QUALITY PROTECTION FOR EXTREME CONDITIONS

Yamalube is designed to work at its best under pressure - the sort it will face every day in Yamaha's mighty 5.3 litre, 32-valve V8 outboard, the F350.

HELPING ENGINES TO LIVE LONGER

By minimizing engineering enemies like spark-plug fouling, ring-sticking and pre-ignition, Yamalube oil protects engines better - for longer.

KEEPING YOUR ENGINE CLEANER

The powerful, efficient action of the anti-oxidants in Yamalube marine lubricants keep engine components clean and prevent the formation of sludge.

ANTI-CORROSION AND ANTI-RUST

Special features fight corrosion and rust, ensuring maximum protection of the engine's internal components against the hazards of the marine environment.

FORMULATED TO NMMA STANDARDS

To be certified by the NMMA (National Marine Manufacturers Association) engine oils must meet their stringent standards for viscosity, corrosion, filter-plugging, foaming and aeration.





YAMALUBE 4-S FULLY SYNTHETIC MARINE OIL

A unique, top-performance marine formula oil, specially developed for high horsepower outboard engines - with the focus on providing improved fuel economy.

FEATURES & BENEFITS

Unique marine formula, compatible with engines with catalytic converters or exhaust gas treatment devices

Provides excellent fuel economy - better than the majority of engine oils in the market

Advanced anti-wear protection for the engine components

Powerful anti-oxidant action to protect engine parts and keep them clean

Unique corrosion inhibitor protects the vital engine parts against the marine environment - both when running and at idle

Keeps the engine ultra-clean and preserves its power

To give your customer the best possible advice, please see the Yamalube application charts on pages 103-105.



SPECIFICATIONS

STANDARDS: Approved as FC-W Catalyst Compatible™, a FC-W Specification, Issued in 2009 by NMMA (National Marine Manufacturers Association) – the only approved 5W30 oil available in the market.

Oil GRADE	SAE	5W-30
Colour	Visual	Brown
Density at 15°C (59°F)	ASTM D1298	0.853 g/cm ³
Kinematic viscosity at 100°C (212°F)	ASTM D445	11.20 mm ² /s
Viscosity index	ASTM D2270	259
Flash point	ASTM D92	225°C
Pour point	ASTM D97	-45°C
Total Base Number	ASTM D2896	7.50 mg KOH/g





YAMALUBE 4-S SUPER SYNTHETIC MARINE OIL

Very high performance motor oil specially developed for 4-stroke outboard motors.

FEATURES & BENEFITS

Approved in rust test and corrosion standard, as specified by the NMMA

Improved fuel economy

Advanced anti-wear protection

Powerful anti-oxidant action to protect engine parts and keep them clean

Unique corrosion inhibitor protects the vital engine parts against the marine environment - both when running and at idle

Good detergency & dispersancy to clean the engine and preserve its power

Excellent shear stability to ensure good lubrication under all conditions

To give your customer the best possible advice, please see the Yamalube application charts on pages 103-105.



SPECIFICATIONS

STANDARDS: Officially approved as FC-WTM by NMMA (National Marine Manufacturers Association)

Oil GRADE	SAE	10W-30
Colour	Visual	Brown
Density at 15°C (59°F)	ASTM D1298	0.879 g/cm ³
Kinematic viscosity at 100°C (212°F)	ASTM D445	10.8 mm ² /s
Viscosity index	ASTM D2270	145
Flash point	ASTM D92	225°C
Pour point	ASTM D97	-37.5°C
Total Base Number	ASTM D2896	6.88 mg KOH/g
Sulphated ash	ASTM D874	0.76 mass %





YAMALUBE 4-S SYNTHETIC MARINE OIL

This high-performance motor oil, has been developed for 4-stroke outboard motors and 4-stroke Yamaha personal watercraft.

FEATURES & BENEFITS

Good anti-wear protection

Powerful anti-oxidant action to protect engine parts and keep them clean

Long lasting protection against engine stress, resulting in smooth operation of the engine

Improved detergency and dispersancy to keep the engine clean and preserve its power & fuel efficiency

Good anti-corrosion and anti-foaming properties

To give your customer the best possible advice, please see the Yamalube application charts on pages 103-105.



SPECIFICATIONS

STANDARDS: Exceeds API SJ standards

Oil GRADE	SAE	10W-30	10W-40
Colour	Visual	Brown	Brown
Density at 15°C (59°F)	ASTM D1298	0.880 g/cm3	0.879 g/cm3
Kinematic viscosity at 100°C (212°F)	ASTM D445	10.8 mm2/s	13.4 mm2/s
Viscosity index	ASTM D2270	147	155
Flash point	ASTM D92	224°C	220°C
Pour point	ASTM D97	-40°C	-40°C
Total Base Number	ASTM D2896	7.64 mg KOH/g	7.61 mg KOH/g
Foam sequence II	ASTM D892	20/0 ml max.	20/0 ml max.
Sulphated ash	ASTM D874	1.0 mass %	1.02 mass %





YAMALUBE 2-W ENGINE OIL

A premium semi-synthetic oil, specially developed, tested and approved by Yamaha for 2-stroke Yamaha personal watercraft engines

FEATURES & BENEFITS

Low ash minimizes plug fouling and pre-ignition

Detergent/dispersant formulation to minimise deposits on pistons and cylinder rings

Good lubricity and anti-scuffing protection for smooth engine operation

Good anti-corrosion and anti-rust capability

Reduces production of exhaust smoke

To give your customer the best possible advice, please see the Yamalube application charts on pages 103-105.



SPECIFICATIONS

Colour	Visual	Purple
Density at 15°C (59°F)	ASTM D1298	0.8628 g/cm ³
Kinematic viscosity at 100°C (212°F)	ASTM D445	6.74 mm ² /s
Viscosity index	ASTM D2270	136
Flash point	ASTM D92	96°C
Pour point	ASTM D97	-42°C
Total Base Number	ASTM D2896	1.6 mg KOH/g

YAMALUBE 2-M SUPER ENGINE OIL

High quality special formulation for 2-stroke marine engines. Developed, tested and approved by Yamaha.

FEATURES & BENEFITS

High quality anti-wear formula to protect against piston binding

Enhances the cleanliness of engine components - particularly the piston and exhaust port - and prevents sludge formation

Outstanding anti-corrosion and anti-rust capability to provide protection for the engine components

Lowers exhaust smoke by burning without leaving sticky deposits

Reduces ring-sticking, spark plug fouling and pre-ignition

Withstands the high temperatures and pressures found in modern engines - low aquatic toxicity

To give your customer the best possible advice, please see the Yamalube application charts on pages 103-105.



SPECIFICATIONS

Colour	Visual	Dark Green
Density at 15°C (59°F)	ASTM D1298	0.8714 g/cm ³
Kinematic viscosity at 100°C (212°F)	ASTM D445	6.807 mm ² /s
Viscosity index	ASTM D2270	145
Flash point	ASTM D92	88°C
Pour point	ASTM D97	-45°C
Total Base Number	ASTM D2896	10.7 mg KOH/g

YAMALUBE STERNDRIVE DIESEL OIL

Special high-performance engine oil developed for gasoline and diesel-powered inboard engines. Developed, tested and approved by Yamaha.

FEATURES & BENEFITS

Better cold flow characteristics make for easier engine starting

Excellent viscosity stability and reduced friction in all conditions

Exceptional anti-wear and anti-corrosion protection that prolongs engine life

Good anti-oxidant action and detergency to protect the engine parts and keep them clean

Strong dispersancy to keep particles in suspension and prevent the build-up of damaging sludge

To give your customer the best possible advice, please see the Yamalube application charts on pages 103-105.



STANDARDS: EQUIVALENT TO API CF SPECIFICATIONS

Viscosity Grade	SAE	15W-40
Colour	Visual	Brown
Density at 15°C (59°F)	ASTM D1298	0.887 g/cm ³
Kinematic viscosity at 100°C (212°F)	ASTM D445	14.7 mm ² /s
Viscosity index	ASTM D2270	135
Flash point	ASTM D92	240°C
Pour point	ASTM D97	-32.5°C
Total Base Number	ASTM D2896	11.0 mg KOH/g
Foam sequence II	ASTM D892	20/0 ml max.
Sulphated ash	ASTM D874	1.6 mass %

YAMALUBE SAE90 GL5 GEAR OIL

This top-performance gear oil was mainly developed to meet the demands of our V8 F350 outboard engine, and is therefore the natural choice for all sterndrive gear cases. Developed, tested and approved by Yamaha.

FEATURES & BENEFITS

Extreme pressure and anti-wear properties give good gear performance under heavy loads and repeated shocks.

Provides very good rust protection against the harsh conditions of the marine environment

High oxidation stability and thermal resistance helps prevent the formation of deposits around seals

Smooth, easy gear shifting is ensured, both at high and low temperatures

Designed to control foaming in the gear case

Retains viscosity and leaves a protective oil film on all surfaces

To give your customer the best possible advice, please see the Yamalube application charts on pages 103-105.



SPECIFICATIONS

STANDARDS: Equivalent to API GL5 specifications

OIL Grade	SAE90	GL5
Colour	Visual	Brown
Density at 15°C (59°F)	ASTM D1298	0.899 g/cm3
Kinematic viscosity at 100°C (212°F)	ASTM D445	16.55 mm2/s
Viscosity index	ASTM D2270	98
Flash point	ASTM D92	232°C
Pour point	ASTM D97	-18°C
Total Acid Number	ASTM D664	2.23 mg KOH/g
Foam sequence II	ASTM D892	10/0 ml max.

YAMALUBE SAE90 GL4 GEAR OIL

A premium quality gear oil developed for all outboard gear cases. Developed, tested and approved by Yamaha.

FEATURES & BENEFITS

Better cold flow characteristics ensure easier engine starting

Excellent viscosity stability in use, with reduced friction

Exceptional anti-wear and anti-corrosion protection to prolong engine life

Good anti-oxidant action and detergency to protect engine parts and keep them clean

Strong dispersancy to keep carbon particles in suspension and prevent the build-up of damaging sludge

To give your customer the best possible advice, please see the Yamalube application charts on pages 103-105.



SPECIFICATIONS

STANDARDS: Equivalent to API CF specifications

OIL Grade	SAE90	GL4
Colour	Visual	Brown
Density at 15°C (59°F)	ASTM D1298	0.895 g/cm3
Kinematic viscosity at 100°C (212°F)	ASTM D445	15.22 mm2/s
Viscosity index	ASTM D2270	97
Flash point	ASTM D92	224°C
Pour point	ASTM D97	-18°C
Total Acid Number	ASTM D664	1.06 mg KOH/g
Foam sequence II	ASTM D892	10/0 ml max.

YAMALUBE GEAR OIL PUMP

This handy pump makes light work of gearbox oil changes on outboards. Designed to fit the Yamalube 1 Litre gear oil containers, it comes complete with adapters to fit the gearbox fillers on all Yamaha models, as well as most other leading brands.

FEATURES & BENEFITS

Simple and compact

Easy operation



PACKAGING SIZE	CONTAINER TYPE	PACK LOT	PART NUMBER	PRICE
1 Pcs		1x	YMD-GL4PM-P1-00	

YAMALUBE LICAL GREASE

Premium multi-purpose grease - combining the advantages of both lithium and calcium - dispersed in highly refined base oils. It contains anti-wear and extreme pressure additives, anti-oxidants and corrosion inhibitors. Developed, tested and approved by Yamaha.

FEATURES & BENEFITS

Mixability with almost all other conventional soap greases

Excellent mechanical stability prevents ejection - or losses of consistency - even under severe operating conditions

Very good pumpability

Does not contain lead or other heavy metals considered harmful to health or the environment

Outstanding water-resistance. In fact, no significant change in performance has been observed, even when this grease has been deliberately contaminated with water

Can help to lower maintenance costs

Equivalent to ISO 6743-9: L-XBDHB 2 and DIN 51 502: KP2K – 25 standards



PACKAGING SIZE	CONTAINER TYPE	PACK LOT	PART NUMBER	PRICE
250 ML	Tube	12x	YMD-69010-0T-A3	
400 GR	Cartridge	1x	YMD-69010-0C-02	

YAMALUBE CONTACT CLEANER

A non-chlorinated degreasing agent which removes persistent dirt, grease and grime from contacts, electrical systems and spark plugs.

FEATURES & BENEFITS

The exclusive formula replaces standard chlorinate-based cleaners and is therefore less aggressive to some plastics.

APPLICATION

Spray from a short distance directly onto dirty areas

Allow approximately 10 seconds to dry

Finish drying off with a rag or compressed air



PACKAGING SIZE	CONTAINER TYPE	PACK LOT	PART NUMBER	PRICE
400 ML	Aerosol can	12x	YMD-65049-A0-92	

YAMALUBE PAINT & PLASTIC POLISH

The powered vehicle industry uses more and more high-quality metal, plastic and Perspex parts, treated with different paints, varnish, dyes and finishes. Yamalube Paint & Plastic Polish restores and maintains a deep gloss on almost any smooth surface.

FEATURES & BENEFITS

Removes fine scratches, treats matt areas and revitalizes colours

Economical - easy to handle and use

Solvent-free

Water-repellent

APPLICATION

Shake well before use. Apply sparingly with a cloth or polishing swab.

Polish off with a soft polishing cloth

For surfaces on motorcycles and scooters, such as:

- Lacquered metal parts (uni-colour, multi-colour, metallic paints)
- Dyed or varnished smooth plastic parts
- Perspex panels
- Helmet visors
- Airbrushed, weathered or refurbished paint
- Painted rims
- Decorative stickers and decals - it will not remove them



PACKAGING SIZE	CONTAINER TYPE	PACK LOT	PART NUMBER	PRICE
220 ML	Aerosol can	12x	YMD-65049-00-61	

YAMALUBE CARBURETTOR & INJECTOR CLEANER

A powerful formula, specially developed to eliminate deposits and varnish on butterfly valves, throttie-chambers, nozzles, tanks, floats, and venturi tubes.

FEATURES & BENEFITS

Reduces fuel consumption while increasing engine performance. It also helps the engine idle more evenly and improves acceleration - clean engines last longer too!

APPLICATION

With the engine turned off, disassemble the air filter and spray the Yamalube Carburettor & Injector Cleaner into the air intake pipe

Leave for 10 minutes

Repeat with the engine on, spraying the product directly onto nozzles, throttle-chambers etc.



PACKAGING SIZE	CONTAINER TYPE	PACK LOT	PART NUMBER	PRICE
400 ML	Aerosol can	12x	YMD-65049-A1-01	

YAMALUBE CLEANING GEL

This cleaning gel is designed for use on all components to remove dirt, grime and grease quickly and efficiently. Its gentle acid and alkaline-free formula ensures that there's no risk of damage or staining.

FEATURES & BENEFITS

Removes the toughest contaminants actively and without residue

Incorporates anti-corrosion additives

Adheres strongly, even to vertical surfaces

Dries without residue and leaves a lasting shine

APPLICATION

Spray the entire vehicle with Yamalube Cleaning Gel, let it work in for 5 minutes, then rinse down thoroughly with a strong water jet

For extreme contamination (e.g. chain grease or encrusted oil) leave it to work for up to 30 minutes after application before thoroughly rinsing down, until there is no more noticeable foaming - if necessary, a sponge can be used to remove the toughest blemishes or dirt.

Do not use under hot sun or apply to heated surfaces!



TYPE	PACKAGING SIZE	CONTAINER TYPE	PACK LOT	PART NUMBER	PRICE
Pro-Active Cleaning Gel	1 L	Bottle	6x	YMD-65049-00-21	
Pro-Active Cleaning Gel	25 L	Barrel	1x	YMD-65049-00-41	
Tap for 25 L barrel	1 Pcs		3x	YMD-65049-P0-20	

YAMALUBE PARTS CLEANER

Yamalube Parts Cleaner is a potent multipurpose degreaser designed to clean and degrease metal parts.

FEATURES & BENEFITS

Brings engine back to its original appearance

Effectively dissolves and removes tar stains, dirty grease, oil, fuel and grime without the need for water

Safe on most rubber, plastic and painted metal surfaces

APPLICATION

Spray 20 cm from the surface

Allow approximately 10 seconds to dry

Respray on very dirty areas



PACKAGING SIZE	CONTAINER TYPE	PACK LOT	PART NUMBER	PRICE
400 ML	Aerosol can	12x	YMD-65049-A0-71	

YAMALUBE WEATHER PROTECTION SPRAY

Suitable for: Rust and corrosion, caused by wetness and humidity, eat away at metal parts thus reducing its value and appeal. Not many know there is a reliable and effective protection against it. Yamalube Weather Protection Spray protects and prevents metal parts from corrosion.

FEATURES & BENEFITS

With regular use, reliably protects all metal parts of the vehicle against corrosion and stops existing corrosion in its tracks

Forms a "self-healing", transparent protective film that closes immediately again after being touched, making it better than wax

Perfect for winter lay-up to protect against salt

Lubricates and displaces moisture

APPLICATION

Shake the can before use. Only apply the product to clean, dry surfaces

Spray on the product evenly and sparingly, or apply with a soaked cloth, and wipe down with a soft cloth afterwards. For winter lay-up, spray on generously (without wiping off)

Tip: The product can be easily removed with Yamalube Cleaning Gel

Note: Do not spray on hot surfaces! Do not spray on brake disks or tyre tread!



PACKAGING SIZE	CONTAINER TYPE	PACK LOT	PART NUMBER	PRICE
300 ML	Aerosol can	6x	YMD-65049-A0-51	

YAMALUBE SILICON SPRAY

Black engine parts often suffer from dulling as a result of the harsh environment to which they are exposed and especially from the effect of sun-bleaching. Yamalube Silicon Spray restores and refreshes sun-bleached parts while protecting plastics.

FEATURES & BENEFITS

Yamalube Silicon Spray serves to optically refurbish:

- Greyed and bleached metal motorcycle parts painted or unpainted (e.g. engine block, frame, fork, engine side covers, rims, etc.)

- Rough and varnished plastic and rubber parts (e.g. side panels, inside panels, mudguards, fixtures, carbon parts, top case, plastic case, blinkers, mirrors, etc.)

APPLICATION

Wash the vehicle thoroughly with Yamalube Cleaning Gel and then chamois it down

Shake the can well and spray on a thin, even coat from about 20 cm away. Then allow to dry thoroughly

Wipe down any smooth plastic parts, such as linings, with an absorbent cloth after application

Note: To protect surfaces that may not be treated (e.g. tyres, seat, speedometer cover), only apply the product to rims, linings, fittings etc. with a soaked cloth. Do not spray directly onto these parts!



PACKAGING SIZE	CONTAINER TYPE	PACK LOT	PART NUMBER	PRICE
300 ML	Aerosol can	6x	YMD-65049-A0-41	

Application charts for Yamalube marine products

YAMALUBE LUBRICANTS FOR: OUTBOARD ENGINES, WAVERUNNERS AND HYDRADRIVE (STERNDRIVE) ENGINES

APPLICATION	SAE	AVAILABLE PACKAGING SIZE	CONTAINER TYPE	PACK LOT	PART NUMBER	PRICE	ON PAGE		
4-S Fully Synthetic Marine Oil									
4-stroke engines	5W-30	1 L	Bottle	12x	YMD-63080-01-00		78		
		4 L	Bottle	4x	YMD-63080-04-00		78		
4-S Super Synthetic Marine Oil									
4-stroke engines	10W-30	1 L	Bottle	12x	YMD-63070-01-00		79		
		4 L	Bottle	4x	YMD-63070-04-00		79		
		60 L	Barrel	1x	YMD-63070-60-00		79		
4-S Synthetic Marine Oil									
4-stroke engines	10W-30	1 L	Bottle	12x	YMD-63050-01-00		80		
		4 L	Bottle	4x	YMD-63050-04-00		80		
		60 L	Barrel	1x	YMD-63050-60-00		80		
		200 L	Drum	1x	YMD-63052-20-80		80		
	10W-40	1 L	Bottle	12x	YMD-63060-01-00		80		
		4 L	Bottle	4x	YMD-63060-04-00		80		
		60 L	Barrel	1x	YMD-63060-60-00		80		
		200 L	Drum	1x	YMD-63062-08-00		80		
		2-W engine oil WaveRunner							
		2-stroke engines	NA	1 L	Bottle	12x	YMD-63023-01-00		81
4 L	Bottle			4x	YMD-63023-04-00		81		
2-M Super engine oil Outboard Engines									
2-stroke engines	NA	1 L	Bottle	12x	YMD-63021-01-A3		82		
		4 L	Bottle	4x	YMD-63021-04-00		82		
		60 L	Barrel	1x	YMD-63021-60-03		82		
Sterndrive diesel oil									
Sterndrive diesel engines	15W-40	1 L	Bottle	12x	YMD-63042-01-A3		82		
		4 L	Bottle	4x	YMD-63042-04-00		82		
		60 L	Barrel	1x	YMD-63042-60-00		82		
SAE90 GL5 gear oil									
V8 F350 outboard engine & all sterndrive gear cases	NA	1 L	Bottle	12x	YMD-73011-10-03		83		
		20 L	Barrel	1x	YMD-73011-20-03		83		
		60 L	Barrel	1x	YMD-73011-60-02		83		
		200 L	Drum	1x	YMD-73011-20-52		83		
SAE90 GL4 gear oil									
All outboard gear cases	NA	250 ML	Tube	12x	YMD-73010-0T-A3		83		
		1 L	Bottle	12x	YMD-73010-10-A3		83		
		20 L	Barrel	1x	YMD-73010-20-03		83		
		60 L	Barrel	1x	YMD-73010-60-02		83		
		200 L	Drum	1x	YMD-73010-20-52		83		

YAMALUBE CARELINE

APPLICATION	AVAILABLE PACKAGING SIZE	CONTAINER TYPE	PACK LOT	PART NUMBER	PRICE	ON PAGE
Lical Grease						
Outboard, personal watercraft and inboard gear cases	250 ML	Tube	12x	YMD-69010-0T-A3		84
	400 GR	Cartridge	12x	YMD-69010-0C-02		84
Gear Oil Pump						
Gear oil pump 1L	1 Pcs		1x	YMD-GL4PM-P1-00		84

YAMALUBE LUBRICANTS FOR: OUTBOARD ENGINES (BY MODEL)

HP	MODEL	ENGINE OIL			Yamalube TYPE	ENGINE OIL CHANGE QUANTITY (LITRE)	GEAR OIL		
		SAE					SAE	GRADE	LITRE
4-Stroke									
2.5	F2.5A	10W-30	10W-40		•	0.4	90	GL-4	0.75
4	F4A	10W-30	10W-40		•	0.5	90	GL-4	0.1
4 ~ 6	F4B / F5A / F6C	10W-30	10W-40		•	0.6	90	GL-4	0.1
6 ~ 8	F6B / F8C / F8F / FT8D / FT8G	10W-30	10W-40		•	0.8	90	GL-4	F: 0.15 / FT: 0.37
9.9	F9.9F / FT9.9G	10W-30	10W-40		•	0.8	90	GL-4	F: 0.15 / FT: 0.37
9.9 ~ 15	F9.9C / FT9.9D / F15A / F15B	10W-30	10W-40		•	1.2	90	GL-4	F: 0.25 / FT: 0.37
9.9 ~ 20	F9.9H / F13.5B / F15C / F20B / F20C	10W-30	10W-40		•	1.8	90	GL-4	0.3
20 ~ 25	F20D / F25D / FT25F	10W-30	10W-40		•	1.6	90	GL-4	F: 0.32 / FT: 0.43
25	F25G	10W-30	10W-40		•	1.1	90	GL-4	0.37
30 ~ 40	F30A / F30B / F40B / F40F	10W-30	10W-40		•	1.7	90	GL-4	0.43
30 ~ 40	F30B / F40F	10W-30	10W-40		•	1.7	90	GL-4	0.43
40 ~ 60	F40D / F50F / F50D / FT50C / F60C / FT50G / FT60T	10W-30	10W-40		•	2.1	90	GL-4	F: 0.43 / FT: 0.67
70	F70A	10W-30	10W-40		•	2.1	90	GL-4	0.67
80 ~ 100	F80B / F100D	10W-30	10W-40		•	3.7	90	GL-4	0.67
80 ~ 100	F80C / F100B	10W-30	10W-40		•	3.7	90	GL-4	0.76
115	F115A / FL115A	10W-30	10W-40		•	3.7	90	GL-4	F: 0.76 / FL: 0.72
115	F100F / F115B / FL115B / F130A	10W-30	10W-40		•	3.2	90	GL-4	F: 0.76 / FL: 0.72
150	F150A / FL150A / F150D / FL150D	10W-30	10W-40		•	4.7	90	GL-4	F: 0.98 / FL: 0.87
175	F175A	10W-30	10W-40		•	4.5	90	GL-4	0.98
200	F200F / FL200F / F200G / FL200G	10W-30	10W-40		•	4.5	90	GL-4	0.98
200	F200A / FL200A / F200B / FL200B / F200C / FL200C	10W-30	10W-40		•	4.7	90	GL-4	F: 1.15 / FL: 1.0
225	F225A / FL225A / F225B / FL225B	10W-30	10W-40		•	4.7	90	GL-4	F: 1.15 / FL: 1.0
225	F225C	10W-30	10W-40		•	4.7	90	GL-4	0.92
250	F250A / FL250A / F250B / FL250B	10W-30	10W-40		•	4.7	90	GL-4	F: 1.15 / FL: 1.0
225 ~ 300	F225F / FL225F / F250D / FL250D / F300B / FL300B	10W-30	10W-40		•	6.3	90	GL-5	F: 1.04 / FL: 1.0
300 ~ 350	F300A / FL300A / F350A / FL350A	10W-30	10W-40		•	6.5	90	GL-5	F: 1.52 / FL: 1.31
425	XF425/F425A	10W30	10W40	5W30	•	7.8	90	GL-5	1.950
425	XF425/FL425A	10W30	10W40	5W30	•	7.8	90	GL-5	1.850
2-Stroke									
4 ~ 5	4A/B/C ~ 5C	TCW3-RL	NA		+	NA	90	GL-4	0.1
6 ~ 8	6C ~ 8C	TCW3-RL	NA		+	NA	90	GL-4	0.16
9.9 ~ 15	9.9D / 9.9F ~ 15D / 15F	TCW3-RL	NA		+	NA	90	GL-4	0.19
20	20C	TCW3-RL	NA		+	NA	90	GL-4	0.18
20 ~ 25	20D ~ 25D	TCW3-RL	NA		+	NA	90	GL-4	0.37
25 ~ 30	25B/X ~ 30H	TCW3-RL	NA		+	NA	90	GL-4	0.32
25 ~ 30	25J ~ 30D	TCW3-RL	NA		+	NA	90	GL-4	0.2
40 ~ 50	40V/X/Y ~ 50H	TCW3-RL	NA		+	NA	90	GL-4	0.43
50 ~ 55	50G ~ 55B	TCW3-RL	NA		+	NA	90	GL-4	0.5
60 ~ 90	60F / 70B / 75A / 80A / 85A / 90A	TCW3-RL	NA		+	NA	90	GL-4	0.61
115 ~ 130	115A ~ 130C	TCW3-RL	NA		+	NA	90	GL-4	0.61
150	150A/F/G/J	TCW3-RL	NA		+	NA	90	GL-4	0.98 / L: 0.87
150 ~ 200	Z150P ~ Z200P	TCW3-RL	NA		+	NA	90	GL-4	Z: 0.98 / LZ: 0.87
175 ~ 200	175A/B/D/F/G/H ~ 200G	TCW3-RL	NA		+	NA	90	GL-4	0.98
200	200A/C/F/H/J	TCW3-RL	NA		+	NA	90	GL-4	0.98 / L: 0.87
200	Z200N / LZ200N	TCW3-RL	NA		+	NA	90	GL-4	Z: 0.98 / LZ: 0.87
200	Z200P/Q	TCW3-RL	NA		+	NA	90	GL-4	0.98
225 ~ 250	225B/C/D/F/G/H ~ 250A/C/D/G	TCW3-RL	NA		+	NA	90	GL-4	1.15 / L: 1.0
250 ~ 300	Z250C/D/F - LZ250C/D/F ~ Z300A/LZ300A	TCW3-RL	NA		+	NA	90	GL-4	Z: 1.15 / LZ: 1.0
300	Z300B	TCW3-RL	NA		+	NA	90	GL-4	1.0

YAMALUBE LUBRICANTS FOR: WAVERUNNERS

ENGINE OIL

MODEL	SAE	Yamalube OIL TYPE	ENGINE OIL CHANGE QUANTITY (LITRE)
4-Stroke			
VX Sport/VX Deluxe/VX Cruiser/V1	10W-30	Synthetic or semi-synthetic engine oil	2.2
FX SHO/FX Cruiser SHO	10W-30	Synthetic or semi-synthetic engine oil	3.1
FX HO/FX Cruiser HO	10W-30	Synthetic or semi-synthetic engine oil	3.1
FZR / FZS	10W-30	Synthetic or semi-synthetic engine oil	3.1
VXS/VXR	10W-30	Synthetic or semi-synthetic engine oil	3.1
FX SVHO/FX Cruiser SVHO	10W-30	Synthetic or semi-synthetic engine oil	3.6
FZR SVHO / FZS SVHO	10W-30	Synthetic or semi-synthetic engine oil	3.6
2-Stroke			
GP1300	NA	2-W engine oil	NA

YAMALUBE LINE-UP CONVERSION TABLE

	Old Line Up		Line Up		
Usage	4-Stroke		Especially good for low/medium/high HP	Especially good for medium/high HP	Especially good for high HP
IF USED	Fuel ECO 10W30	UPGRADE TO	Synthetic 10W30	OR Super Synthetic FC-W 10W30	OR Fully Synthetic FC-W 5W30
IF USED	Fuel ECO 10W40	UPGRADE TO	Synthetic 10W40		
IF USED	FC-W 10W30	UPGRADE TO		OR Super Synthetic FC-W 10W30	Fully Synthetic FC-W 5W30
IF USED	FC-W 10W40	UPGRADE TO		OR Super Synthetic FC-W 10W30	Fully Synthetic FC-W 5W30

FULLY SYNTHETIC FC-W 5W30

This premium marine engine oil offers excellent fuel economy and extended oil drain intervals, along with ultimate engine cleanliness & protection. Important note: Use this oil only after the running-in period - and for engines with low mileage. As a guide, we recommend you do not use this oil for an engine which is more than 7 years old.





FOLDING RE-BOARDING STEP

Provides a wide-step surface for ease of boarding, especially in deep water.

Part No.
MWV-FSTEP-VX-11
MWV-FSTEP-FX-06
MWV-FSTEP-FZ-09



FENDER

Engineered specifically for WaveRunners. Easy to hang wherever your craft needs protection.

Part No.
MWV-WVRNR-HH-BL (BLUE)
MWV-WVRNR-HH-BK (BLACK)



STORAGE PACK

Need to bring along items that you do not want to move around in the storage compartment or get wet, such as keys, wallets, pagers or cell phones? This pack is your answer.

Part No. MWV-BOWPA-CK-00



PULL-UP CLEAT

This pop-up cleat can be easily retrofitted and stows flush to maintain the sleek lines of your WaveRunner. A simple and stylish way to tether your ride.

Part No. MWV-PUCLE-AT-07



WAVERUNNER DOCK LINE

To easily dock your WaveRunner get the Yamaha dockline, made of floating multi-filament polypropylene, oil, gas, UV, mildew & salt water resistant. Black, 1cm diameter line.

Part No.
MWVDLINE12BK 3.65m (12ft)
SBTDLINE15BK 4.55m (15ft)



COVER STORAGE BAG

Yamaha's handy storage bag gives you a place to store your WaveRunner cover neatly while not in use. Made of the same durable material as the Yamaha WaveRunner cover.

Part No. MWV-WVRNR-BG-01



WaveRunner Lifting Harness

Very useful in moving even the heaviest PWC. Brackets grip tight and are vinyl coated to help protect the finish. Two large stainless steel D-rings can be easily connected to a davit or other suitable lifting mechanism. Double-layer, high-strength webbing has superior UV and saltwater resistance. Rated up to 500kg.

Part No. MWVLFTHRES10



WaveRunner STAND

For more details please contact your local dealer.

Part No. M_WS1P

WAVERUNNER COVERS

These tough, durable covers are specifically designed to fit the sleek curves and powerful shape of your machine – so it looks good even when it's not on the water.



Fuel filler access



Ventilation system



Eyelet access

The highest quality water-resistant materials are used, so they shrug off the damaging elements and protect your cover against fading and rot.

Important note: During transport, the cover must always be secured with straps running under the watercraft, using the special reinforced eyelets on the cover sides.



Fuel filler access - The precisely placed zip opening allows easy access to the fuel filler cap without the need to remove the cover.

Eyelet access - The cover allows easy access to the eyelets at the front and stern of the craft for securing with dock lines – or when using tie-down straps for transportation.

Ventilation system - To reduce the risk of humidity formation, these covers have a special ventilation system to allow air to circulate freely around the machine when in storage. The design also helps create a partial vacuum under the cover when moving on a trailer during transport, drawing it more tightly against the hull and topside surfaces.

Model	2019	2017-2019	2017-2015
EX DELUXE SERIES		Black/Charcoal MWVCVREXDL18	Black/Charcoal (17') MWV-CVREX-DL-17
EX SPORT SERIES		Black/Charcoal MWVCVREXDL18	Black/Charcoal (17') MWV-CVREX-BS-17
EXR	Black/Charcoal MWVCVREXDL18		
EX		Black/Charcoal MWVCVREXBS18	
GP1800 SERIES		Black/Charcoal MWVCVRGP0018	Black/Charcoal (17') MWV-CVRGP-00-17
FZR SERIES			Charcoal/Grey (09'-16') MWV-CVRFZ-GY-15
FZS SERIES			Black/Grey (09'-16') MWV-CVRFZ-BG-15
FX SERIES	Charcoal/Black MWVCVRFXCH19		Charcoal/Grey (12'-16') MWV-CVRFX-CH-12
FX CRUISER SERIES	Charcoal/Black MWVCVRCRCH19		Charcoal/Grey (12'-16') MWV-CVRCR-CH-12
VXR SERIES			Black/Charcoal MWV-CVRVR-BC-15
VXS SERIES			Black/Charcoal MWV-CVRVS-BC-15
VX DELUXE/SPORT SERIES/VX			Black/Charcoal MWV-CVRVX-BC-15
VX CRUISER SERIES			Black/Charcoal MWV-CVRVX-CR-15
V1 SERIES			Black/Charcoal MWV-CVRV1-CH-15
SUPERJET			Black MWV-CVRSJ-GY-12







WING TUBE 1P RED
Part No. N18-GMP16-C0-00



WING TUBE 1P BLUE
Part No. N18-GN016-E0-00



FUNTUBE 1P RED
Part No. N18-GN012-C0-00



FUNTUBE 1P BLUE
Part No. N18-GN012-E0-00



DECK TUBE 2P RED
Part No. N18-GN014-C0-00



DECK TUBE 2P BLUE
Part No. N18-GN014-E0-00



SHUTTLE 3P RED
Part No. N18-GN015-C0-00



SHUTTLE 3P BLUE
Part No. N18-GN015-E0-00



TOWABLE CHAIR 2P RED
Part No. N18-GN017-C0-00



TOWABLE CHAIR 2P BLUE
Part No. N18-GN017-E0-00



WATERSKI RED
Part No. N18-GN018-C0-00



WATERSKI BLUE
Part No. N18-GN018-E0-00



INFLATABLE STAND UP PADDLEBOARD

Part No. YMM-H17SU-PP-C3



INFLATABLE CHAIR RED

Part No. N18-GN019-C0-00



INFLATABLE CHAIR BLUE

Part No. N18-GN019-E0-00



BODYBOARD RED

Part No. N18-GN021-C0-00



BODYBOARD BLUE

Part No. N18-GN021-E0-00



PACKABLE BACKPACK

Part No. T18-HB00C-01-00



TOW ROPE 4P

Part No. N18-GN013-C4-00



BIG RED DRY BAG

Part No. T18-HD009-C0-00



BIG BLUE DRY BAG

Part No. T18-HD009-E0-00



SMALL RED DRY BAG

Part No. T18-HD010-C0-00



SMALL BLUE DRY BAG

Part No. T18-HD010-E0-00



WaveRunner MEN'S FULL SUIT

Part No. D18-AL101-B7 **XX**

SIZE: 0S-0M-0L-1L-2L-3L



WaveRunner MEN'S LONG JOHN JACKET

Part No. D18-AL102-B7 **XX**

SIZE: 0S-0M-0L-1L-2L-3L



WaveRunner MEN'S SHORTY

Part No. D18-AL103-B7 **XX**

SIZE: 0S-0M-0L-1L-2L



WaveRunner MEN'S FRONT ENTRY VEST

Part No. D18-AJ114-B7 **XX**

SIZE: 0S-0M-0L-1L-2L



WaveRunner WOMEN'S SHORTY

Part No. D18-AL203-B7 **XX**

SIZE: 0S-0M-0L-1L



WaveRunner WOMEN'S FRONT ENTRY VEST

Part No. D18-AJZ14-B7 **XX**

SIZE: 0S-0M-0L-1L-2L



WaveRunner 4 BUCKLE LIFE VEST

Part No. D18-AJ314-B7 **XX**

SIZE: 1S-0S-0M-0L-1L-2L-3L



WaveRunner GLOVES

Part No. D18-AN103-B7 **XX**

SIZE: 1S-0S-0M-0L-1L-2L-3L



WaveRunner NEOPRENE SHOES

Part No. D18-AF301-B7 **XX**

SIZE: 35-36-37-38-39-40-41-42-43-44



WaveRunner NEOPRENE JACKET

Part No. D18-AJ115-B7 **XX**

SIZE: 0S-0M-0L-1L-2L



WaveRunner T-SHIRT

Part No. B18-GT101-B0 **xx**
SIZE: 1S-0S-0M-0L-1L-2L-3L



WaveRunner HOODY

Part No. B18-GT107-B0 **xx**
SIZE: 1S-0S-0M-0L-1L-2L-3L



WaveRunner CAP GREY

Part No. N18-GH100-F0-00



WaveRunner CAP BLUE

Part No. N18-GH100-E0-00



WaveRunner RACE MEN'S LONG JOHN WETSUIT

Part No. D17-AL1E0-E0 **XX**
SIZE: 0S-0M-0L-1L-2L-3L



WaveRunner RACE MEN'S FRONT ENTRY VEST

Part No. D17-AJ114-E0 **XX**
SIZE: 0S-0M-0L-1L-2L



WaveRunner RACE GLOVES

Part No. D17-AN103-E0 **XX**
SIZE: 1S-0S-0M-0L-1L-2L



WaveRunner RACE RASH GUARD

Part No. D17-AT114-E0 **XX**
SIZE: 0S-0M-0L-1L-2L



WaveRunner RACE GOGGLES YELLOW VISOR

Part No. N17-AV004-B5-00



WaveRunner RACE GOGGLES PINK VISOR

Part No. N17-AV004-B7-00



WaveRunner RACE HOODY

Part No. K17-AT106-E4 **XX**
SIZE: 1S-0S-0M-0L-1L-2L-3L



MEN'S BODYWARMER

Part No. H17-AJ105-F0 **XX**
 SIZE: 1S-0S-0M-0L-1L-2L-3L



MEN'S HOODY

Part No. H17-AT106-E4 **XX**
 SIZE: 1S-0S-0M-0L-1L-2L-3L



MEN'S POLO

Part No. H17-AT109-E4 **XX**
 SIZE: 1S-0S-0M-0L-1L-2L-3L



MEN'S STRIPED POLO

Part No. H17-AT112-E8 **XX**
 SIZE: 1S-0S-0M-0L-1L-2L-3L



MEN'S T-SHIRT

Part No. H17-AT114-F0 **XX**
 SIZE: 1S-0S-0M-0L-1L-2L-3L



WOMEN'S JACKET

Part No. H17-AJ201-F0 **XX**
 SIZE: 1S-0S-0M-0L-1L



WOMEN'S SOFTSHELL

Part No. H17-AJ202-E4 **XX**
 SIZE: 1S-0S-0M-0L-1L



WOMEN'S BODYWARMER

Part No. H17-AJ205-E6 **XX**
 SIZE: 1S-0S-0M-0L-1L



WOMEN'S POLO

Part No. H17-AT209-W6 **XX**
 SIZE: 1S-0S-0M-0L-1L



WOMEN'S STRIPED POLO

Part No. H17-AT212-E8 **XX**

SIZE: 1S-0S-0M-0L-1L





REVS Women's Polo - Black
 Part No. B19AT209B0 **XX**
 SIZE: 1S-0S-0M-0L-1L-2L



REVS Women's Polo - Red
 Part No. B19AT209C0 **XX**
 SIZE: 1S-0S-0M-0L-1L-2L



REVS Women's Polo - White
 Part No. B19AT209W0 **XX**
 SIZE: 1S-0S-0M-0L-1L-2L



REVS T-shirts SS Big Stripe - Black
 Part No. B19AT101B **XX**
 SIZE: 1S-0S-0M-0L-1L-2L-3L



REVS T-shirts SS Big Stripe - Red
 Part No. B19AT101C0 **XX**
 SIZE: 1S-0S-0M-0L-1L-2L-3L



REVS T-shirts SS Big Stripe - White
 Part No. B19AT101W0 **XX**
 SIZE: 1S-0S-0M-0L-1L-2L-3L



REVS T-shirt LS - Black
 Part No. B19AT102B0 **XX**
 SIZE: 1S-0S-0M-0L-1L-2L



REVS Tee LS - Sidney
 Part No. B19AT102C0 **XX**
 SIZE: 1S-0S-0M-0L-1L-2L-3L



REVS Tee LS - Black
 Part No. B19AT105B0 **XX**
 SIZE: 1S-0S-0M-0L-1L-2L-3L



REVS Tee LS - Grey

Part No. B19AT105F0 **XX**
 SIZE: 1S-0S-0M-0L-1L-2L-3L



REVS Zipp Hoody - Black

Part No. B19AT107B0 **XX**
 SIZE: 1S-0S-0M-0L-1L-2L-3L



REVS Zipp Hoody - Grey

Part No. B19AT107F0 **XX**
 SIZE: 1S-0S-0M-0L-1L-2L-3L



Polo Small Stripe - Black

Part No. B19AT109B0 **XX**
 SIZE: 1S-0S-0M-0L-1L-2L-3L



Polo Small Stripe - Red

Part No. B19AT109C0 **XX**
 SIZE: 1S-0S-0M-0L-1L-2L-3L



Polo Small Stripe - White

Part No. B19AT109W0 **XX**
 SIZE: 1S-0S-0M-0L-1L-2L-3L



REVS T-shirts SS Small Stripe - Black

Part No. B19AT114B0 **XX**
 SIZE: 1S-0S-0M-0L-1L-2L-3L



REVS T-shirts SS Small Stripe - White

Part No. B19AT114W0 **XX**
 SIZE: 1S-0S-0M-0L-1L-2L-3L



REVS Hoody - Black

Part No. B19AT117B0 **XX**
 SIZE: 1S-0S-0M-0L-1L-2L-3L



REVS Hoody - Red

Part No. B19AT117C0 **XX**
 SIZE: 1S-0S-0M-0L-1L-2L-3L



REVS Women's T-shirt SS Stripe - Black

Part No. B19AT201B0 **XX**
 SIZE: 1S-0S-0M-0L-1L-2L



REVS Women's T-shirt SS Stripe - Red

Part No. B19AT201C0 **XX**
 SIZE: 1S-0S-0M-0L-1L-2L



REVS Women's T-shirt SS Stripe - White

Part No. B19AT201W0 **XX**
 SIZE: 1S-0S-0M-0L-1L-2L



REVS Women's Zip Hoody - Black

Part No. B19AT207B0 **XX**
 SIZE: 1S-0S-0M-0L-1L-2L



REVS Women's Zip Hoody - Grey

Part No. B19AT207F0 **XX**
 SIZE: 1S-0S-0M-0L-1L-2L



REVS Kids T-shirt SS Big Stripe - Black

Part No. B19AT401B0 **XX**
 SIZE: 06-08-10-12-14-16-17



REVS Kids T-shirt SS Big Stripe - Red

Part No. B19AT401C0 **XX**
 SIZE: 06-08-10-12-14-16-17



REVS Kids Zipp Hoody - Red

Part No. B19AT407C0 **XX**
 SIZE: 06-08-10-12-14-16-17



REVS Kids Zipp Hoody - Grey

Part No. B19AT407F0 **XX**
 SIZE: 06-08-10-12-14-16-17



REVS Kids T-shirt SS Small Stripe - Grey

Part No. B19AT414C0 **XX**
 SIZE: 06-08-10-12-14-16-17



REVS Adult Truck Cap - White

Part No. N19AH300B900



REVS Adult Beanie

Part No. N19AH301B900



REVS kids Cap - Red

Part No. N19AH400C100

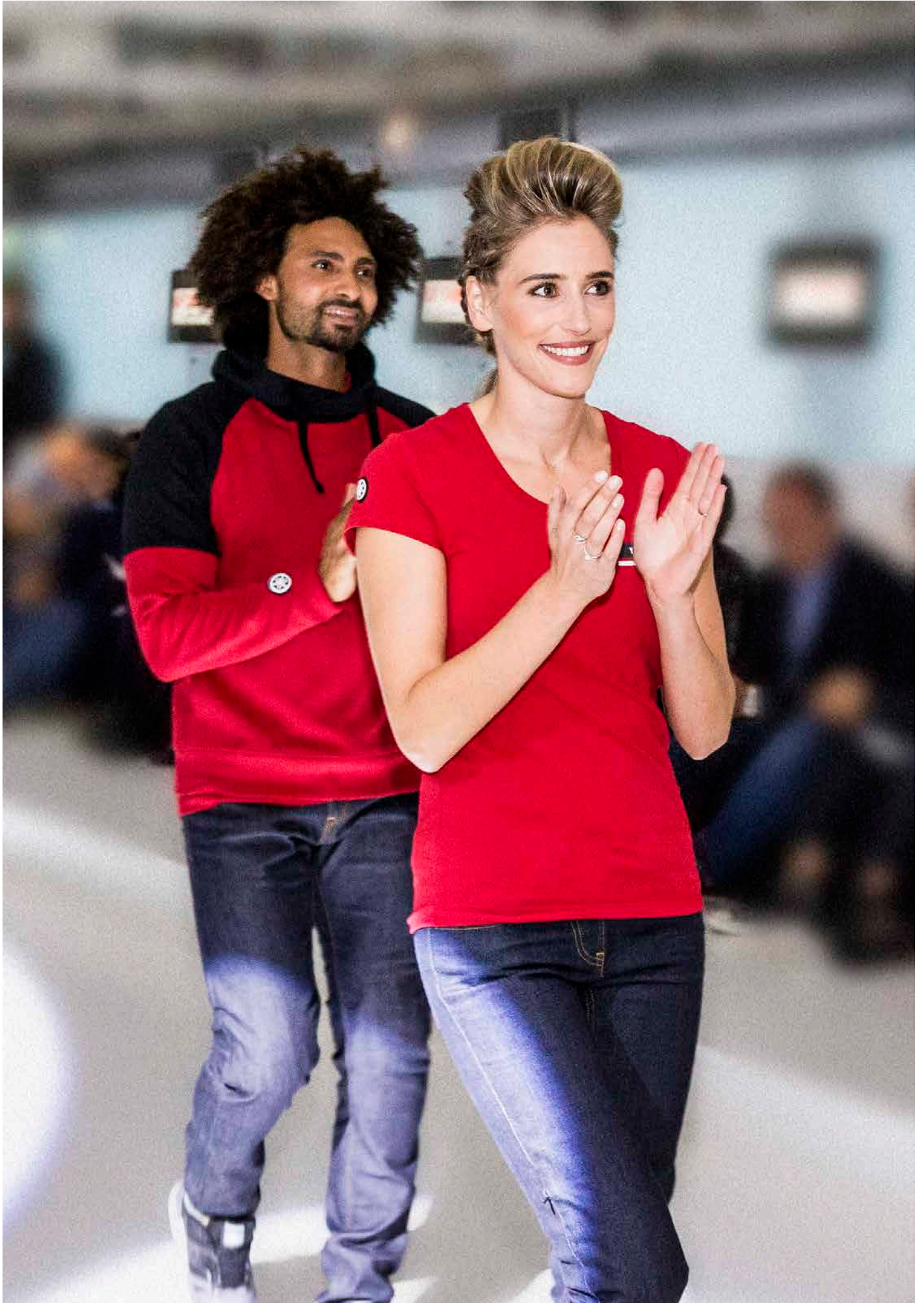



REVS Laptop Sleeve
Part No. N18-SD003-C1-00



RACE Laptop Sleeve
Part No. N18-SD003-E0-00



REVS Ipad Cover
Part No. N18-ND002-C1-00



REVS Power bank
Part No. N18-JV001-C1-00



RACE Power bank
Part No. N18-JV001-E0-00



REVS USB Stick 16 GB
Part No. N18-RT004-C1-00



RACE USB Stick 16 GB
Part No. N18-RT004-E0-00



Blue Lanyard
Part No. N18-JL000-E0-00



Red Lanyard
Part No. N18-NL000-C0-00



Black Lanyard
Part No. N18-NL004-B9-00



Race Lanyard
Part No. N18-JL001-E0-00



Cork Lanyard
Part No. N18-RL002-D2-00



Cork Key Ring

Part No. N18-RD007-D2-00



Wood Key Ring

Part No. N18-ND008-D2-00



Race Key Ring

Part No. N18-JD009-E0-00



REVS Key Ring

Part No. N18-ND009-C1-00



Retractable Race Key Ring

Part No. N18-JD010-E0-00



Retractable REVS Key Ring

Part No. N18-ND010-C1-00



Floating Key Ring

Part No. N18-NL003-C5-00



Yamaha 350 Outboard Floating Keyring

Part No. N13-NK001-00-F0



Yamaha Protective Keyring

Part No. N13-NK005-00-C0



Yamaha Racing Water Bottle

Part No. N18-RD000-5E-00



Yamaha Race Track Chair

Part No. N18-JR010-E0-00



Yamaha Stool

Part No. N13-NP010-00-E0



Carrier Bag
Part No. T18-JB010-E0-00



Race Ceramic Mug
Part No. N18-HD000-E8-00



Race Enamel Mug
Part No. N18-GD000-E8-00



Tow Ball Cap - White
Part No. N18-IN004-M0-00



Tow Ball Cap - Blue
Part No. N18-IN00-4E-00



Yamaha Wall Clock
Part No. N12-NC006-00-M2



Yamaha Collar Pin
Part No. YMD-10075-00-10



Yamaha Umbrella
Part No. N15-NR000-00-B0



Yamaha Racing Umbrella
Part No. N15-NR000-00-E1



Yamaha ATV Plush Toy
Part No. N14-MP607-00-E0



Kids Sunglasses
Part No. N18-JJ412-E1-00



Adults Poncho Towel
Part No. N18-HR313-E0-00



Adults Sunglasses
Part No. N18-JJ112-E1-00



Neoprene Sunglasses Cord
Part No. N18-JJ113-B0-00



Blue Bath Towel
Part No. N18-GR012-E0-00



Grey Bath Towel
Part No. N18-GR012-F0-00



Blue Beach Towel
Part No. N18-HR001-2E-00



Kiddi Rocking WaveRunner
Part No. N19-MN605-E0-00



Overall

- Heavy duty mechanical stretchy canvas
- Equipped with padded knees
- Internal waist adjustment
- Chest pocket and trousers pockets have Velcro closure
- Blind closure prevents scratching
- Reflective pipings
- Adjustable cuffs and hem
- Men's size

Part No. Y17-BS102-B0 **XX**
SIZE: 44-62



Bib and Brace

- Heavy duty mechanical stretchy canvas
- Equipped with padded knees
- Elastic back part for work comfort
- Reflective pipings
- Blind closure prevents scratching
- Adjustable cuffs and hem
- Men's size

Part No. Y17-BS103-B0 **XX**
SIZE: 44-62



Trousers Regular

- Heavy duty mechanical stretchy canvas
 - Equipped with padded knees
 - Internal waist adjustment
 - Reflective pipings
 - Blind closure prevents scratching
 - Adjustable cuffs and hem
 - Men's size
- Also available in a long version

Part No. Y17-BS1R0-B0 **XX**
SIZE: 44-62



Trousers Long

5 cm longer than the 'Mechanic Trousers Regular'

- Heavy duty mechanical stretchy canvas
- Equipped with padded knees
- Internal waist adjustment
- Reflective pipings
- Blind closure prevents scratching
- Adjustable cuffs and hem
- Men's size

Part No. Y17-BS1L0-B0 **XX**
SIZE: 46-58



Bermuda

- Heavy duty mechanical stretchy canvas
- Equipped with padded knees
- Internal waist adjustment
- Reflective pipings
- Adjustable cuffs and hem
- Blind closure prevents scratching
- The length of trousers is over knees
- Men's size

Part No. Y17-BS1H2-B0 **XX**
SIZE: 44-62



Pitshirt

- Twill and cotton-polyester blended fabrics with high performance
- Anti-crinkle
- With invisible pen pocket
- Men's size

Part No. Y17-BT104-B0 **XX**
SIZE: XS-3L



Long Sleeves T-shirt

- 60% cotton and 40% polyester
- Relaxed fit
- Men's size (Long sleeves)

Part No. Y17-BT102-B0 **XX**
SIZE: XS-3L



T-shirt

- 60% cotton and 40% polyester
- Relaxed fit
- Men's size (Short sleeves)

Part No. Y17-BT101-B0 **XX**
SIZE: XS-3L



Polo

- 60% cotton and 40% polyester
- Pique polo
- Men's size

Part No. Y17-BT109-B0 **XX**
SIZE: XS-3L



Bodywarmer

- Padded nylon bodywarmer
- Full length zipped front opening
- Zip closing front pockets
- Inner pocket for personal belongings
- Inner smartphone pocket with Velcro closure
- Reflective piping
- Elastic bottom part
- Men's size

Part No. Y17-BT106-B0 **XX**
SIZE: XS-3L



Softshell

- Windproof, waterproof and breathable fabric
- Shell: 96% polyester and 4% Elastane
- Lining: 100% polyester, Mesh: 100% polyester
- Full length zipped front opening
- Zip closing front pockets
- Elastic draw cord with stopper
- Inner pocket for personal belongings
- Inner smartphone pocket with Velcro closure
- Reflective piping / Stand-up collar
- Men's size

Part No. Y17-BJ102-B0 **XX**
SIZE: XS-3L



Fleece

- 100% polyester anti-pilling fleece
- Full length zipped front opening
- Zip closing front pockets
- Elastic cuffs and bottom part
- Reflective piping
- Men's size

Part No. Y17-BT113-B0 **XX**
SIZE: XS-3L



Corporate Polo Male

- 60% cotton and 40% polyester, pique polo
- Available in two colours, white and navy
- All corporate wear used for office and front shops
- Men's size

Part No. Y17-DT109-W0 **xx** (white)
Y17-DT109-E4 **xx** (navy)

SIZE: XS-3L

Corporate Polo Female

- 60% cotton and 40% polyester, pique polo
- Available in two colours, white and navy
- Women's size

Part No. Y17-DT209-W0 **xx** (white)
Y17-DT209-E4 **xx** (navy)

SIZE: XS-XL

Corporate Shirt Female

- 95% cotton poplin and 5% elastane; anti-crinkle
- Feminine fit
- Women's size

Part No. Y17-DT205-W0 **xx**

SIZE: XS-XL



Corporate Shirt Male (Long sleeve)

- 100% cotton poplin; anti-crinkle
- Relaxed fit
- Available in three colours, white, light blue and navy
- Men's size

Part No. Y17-DT105-W0 **xx** (white)
Y17-DT105-E5 **xx** (light blue)
Y17-DT105-E4 **xx** (navy)

SIZE: XS-3L

Corporate Shirt Male (Short Sleeve)

- 100% cotton poplin; anti-crinkle
- Relaxed fit
- Available in three colours, white, light blue and navy
- Men's size

Part No. Y17-DT104-W0 **xx** (white)
Y17-DT104-E5 **xx** (light blue)
Y17-DT104-E4 **xx** (navy)

SIZE: XS-3L

Size guidance

MEN'S SIZE CHART

Part number variation for different sizes:

1S S1

0S S0

0M M0

0L L0

1L L1

2L L2

3L L3

SIZE	XS	S	M	L	XL	XXL	XXXL			
Chest in cm	83-88	89-94	95-100	101-106	107-112	113-120	121-128			
Waist in cm	73-78	79-84	85-90	91-96	97-102	103-110	111-118			
Hip in cm	85-90	91-96	97-102	103-108	109-114	115-122	123-130			

Part number variation for different sizes:

44

46

48

50

52

54

56

58

60

62

SIZE	44	46	48	50	52	54	56	58	60	62
Chest in cm	86-89	90-93	94-97	98-101	102-105	106-109	110-113	114-119	120-125	126-131
Waist in cm	76-79	80-83	84-87	88-91	92-95	96-99	100-103	104-109	110-115	116-121
Hip in cm	88-91	92-95	96-99	100-103	104-107	108-111	112-115	116-121	122-127	128-133

GUIDE FOR TRADITIONAL MEN'S SIZE CONVERSION

NL,DE,SE,CH,DK,BE,NO,AT	44	46	48	50	52	54	56	58		
IT,ES,PT	44	46	48	50	52	54	56	58		
FR	44/38	46/40	48/42	50/44	52/46	54/48	56/50	58/52		
GB,USA	34	36	38	40	42	44	46	48		
UNISEX	S	S	M	M	L	XL	XL	XXL		

WOMEN'S SIZE CHART

Part number variation for different sizes:

2S S2

1S S1

0S S0

0M M0

0L L0

1L L1

2L L2

3L L3

SIZE	XXS	XS	S	M	L	XL	XXL	XXXL		
Bust in cm	70-73	73-78	79-84	85-90	91-96	97-102	103-110	111-118		
Waist in cm	54-57	57-62	63-68	69-74	75-80	81-86	87-94	95-102		
Hip in cm	80-83	83-88	89-94	95-100	101-106	107-112	113-120	121-128		

Part number variation for different sizes:

32

34

36

38

40

42

44

46

48

50

52

SIZE	32	34	36	38	40	42	44	46	48	50	52
Bust in cm	74-77	78-81	82-85	86-89	90-93	94-97	98-101	102-105	106-111	112-117	118-123
Waist in cm	58-61	62-65	66-69	70-73	74-77	78-81	82-85	86-89	90-95	96-101	102-107
Hip in cm	84-87	88-91	92-95	96-99	100-103	104-107	108-111	112-112	116-121	122-127	128-133

GUIDE FOR TRADITIONAL WOMEN'S SIZE CONVERSION

NL,DE,SE,CH,DK,BE,NO,AT	32	34	36	38	40	42	44	46		
IT,ES,PT	36	38	40	42	44	46	48	50		
FR	34	36	38	40	42	44	46	48		
RUS	38	40	42	44	46	48	50	52		
AUS	8	10	12	14	16	18	20	22		
GB	6	8	10	12	14	16	18	20		
USA	4	6	8	10	12	14	16	18		
UNISEX	XS	S	S	M	L	L	XL	XXL		

MEN VESTS

NEO VEST (50N CERTIFIED)

(ATHLETIC FIT)

(+ SIZES LEISURE FIT)

SIZE	CHEST	WAIST	CHEST	WAIST
XS	90-94 CM	80-84 CM	-	-
S	94-98 CM	84-88 CM	-	-
M	98-102 CM	88-92 CM	-	-
L	102-106 CM	92-96 CM	-	-
XL	106-110 CM	96-100 CM	-	-
XL	-	-	106-112 CM	96-104 CM
2XL	-	-	112-118 CM	104-112 CM

MEN SPORTS WETSUITS

SIZE	CHEST	WAIST	HIP	LENGTH
XS	90-94 CM	80-84 CM	90-94 CM	173-179 CM
S	94-98 CM	84-88 CM	94-98 CM	175-181 CM
M	98-102 CM	88-92 CM	98-102 CM	177-183 CM
L	102-106 CM	92-96 CM	102-106 CM	179-185 CM
XL	106-110 CM	96-100 CM	106-110 CM	181-187 CM
2XL	111-117 CM	101-107 CM	111-117 CM	183-189 CM

WOMEN VESTS

NEO VESTS (CERTIFIED 50N)

SIZE	CHEST	WAIST
XS	82-86 CM	65-69 CM
S	86-90 CM	70-74 CM
M	94-98 CM	78-82 CM
L	102-106 CM	87-92 CM
XL	107-113 CM	93-99 CM

WOMEN SPORTS WETSUITS

SIZE	CHEST	WAIST	HIP	LENGTH
XS	84-88 CM	68-72 CM	90-94 CM	165-171 CM
S	88-92 CM	72-76 CM	94-98 CM	167-173 CM
M	93-99 CM	77-83 CM	99-105 CM	169-175 CM
L	99-105 CM	83-89 CM	105-111 CM	171-177 CM
XL	105-111 CM	89-95 CM	111-117 CM	173-179 CM

UNISEX VESTS

4 BUCKLE VEST (CERTIFIED 50N)

SIZE	CHEST	WAIST
XS	89-95 CM	79-85 CM
S	93-99 CM	83-89 CM
M	97-103 CM	87-93 CM
L	101-107 CM	91-97 CM
XL	105-113 CM	95-103 CM
2XL	111-119 CM	101-109 CM
3XL	117-125 CM	107-115 CM

SHOES ADULT

H2O SHOES 3MM AQUA

US SIZE	EU LENGTH	IN CM
3	36	21
4	37	22,5
5	38	23
6	39	24
7	40-41	25
8	41-42	26
9	43	27
10	44	28,5
11	45	29
12	46	30

VISIT OUR MARINE DEALER WEBSHOP

Dedicated webshop for Dealers

POS material

Corporate items to support Dealer VI program

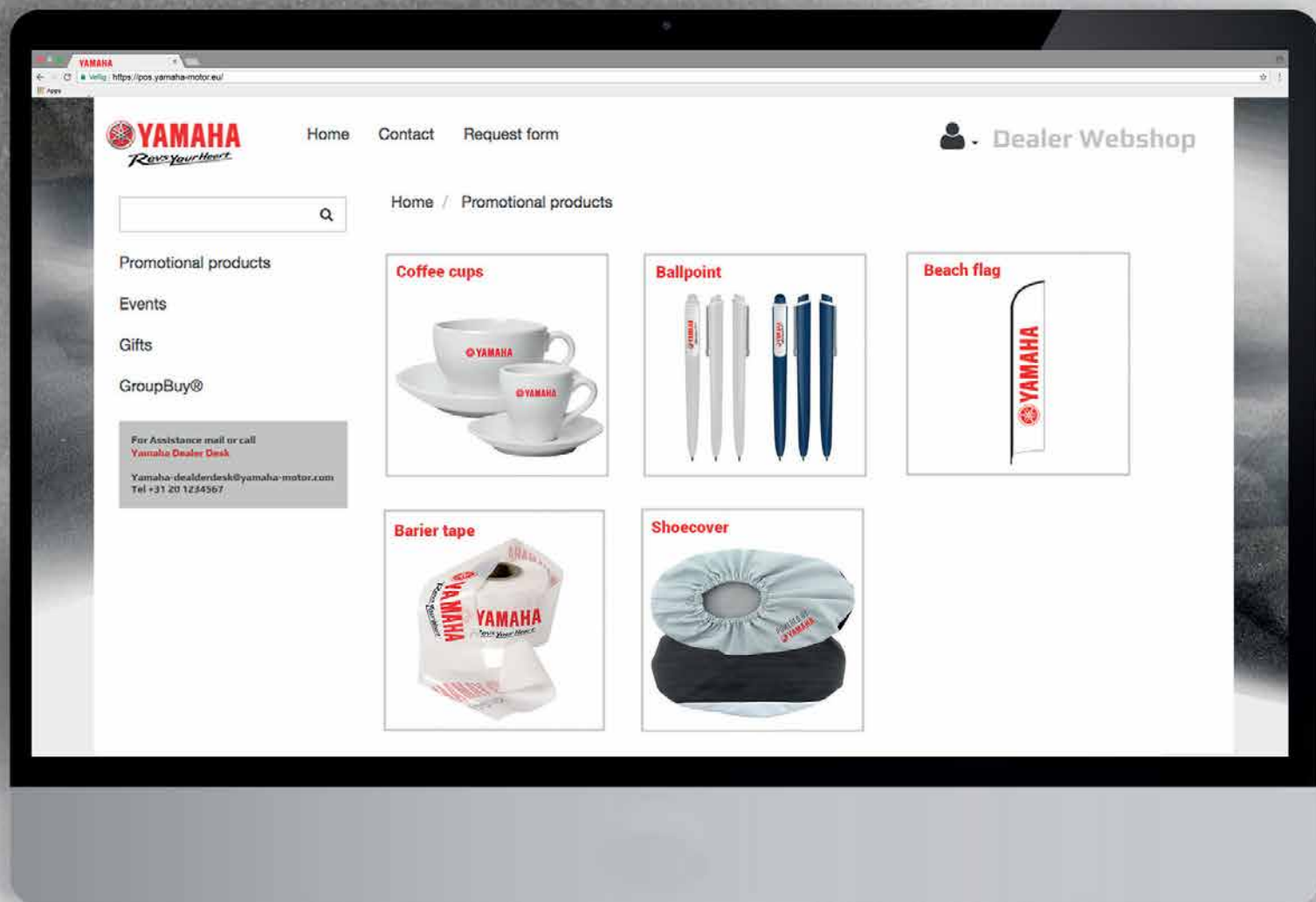

>> Visit the webshop on <http://pos.yamaha-motor.eu>



YAMAHA
Revs Your Heart

www.yamaha-motor.eu

Y U EXPERIENCE

Y U SERVICES

Follow us on:



Yamaha Motor Europe N.V.

Koolhovenlaan 101
1119 NC Schiphol-Rijk
P.O.Box 75033
1117 ZN Schiphol
The Netherlands
+ 31 20 654 6000

Dealer

Disclaimer
All information in this catalogue is given for general guidance only and is subject to change without prior notice. Photographs may show boats being driven by professionals and no recommendation or guidance in respect of safe operation or style of use is intended or implied by the publication of these images. Always respect the local maritime regulations. Always wear the recommended personal floatation device and safety equipment when boating. Specifications, prices and/ or appearance of Yamaha products and non Yamaha branded products are subject to change without prior notice. Non Yamaha branded products as depicted in this brochure/catalogue are fully developed and produced by respected third parties. Yamaha does not guarantee the availability of the displayed products in local markets. The product range may be limited in some countries and Yamaha has the right to discontinue products without prior notice. Where applicable, prices of Yamaha products may vary according to local requirements and conditions. No rights can be obtained from this information. Sizes of the apparel displayed are indicative – Yamaha recommends you to visit your local Yamaha dealer for the best fit. For further details and availability, please contact your local Yamaha dealer.

