

# ***JOBE WATERSPORTS*** '19

DEALERBOOK EXPORT



**JOBE** 

# INDEX

## VESTS

<b>TECH</b>	<b>12</b>
<b>SIZING</b>	<b>13 - 14</b>
4 BUCKLE VEST BLACK	38
4 BUCKLE VEST BLUE	37
4 BUCKLE VEST RED	36
COMFORT BOATING VEST ORANGE	63
COMFORT BOATING VEST YOUTH ORANGE	61
COMFORT BOATING VEST YOUTH YELLOW	62
DUAL VEST BLUE	32
DUAL VEST LIME GREEN	33
DUAL VEST RED	31
EASY BOATING PACKAGE	64
NEOPRENE VEST MEN BLACK	50
NEOPRENE VEST MEN BLUE	48
NEOPRENE VEST MEN LIME GREEN	49
NEOPRENE VEST MEN RED	47
NEOPRENE VEST WOMEN BORDEAUX RED	41
NEOPRENE VEST WOMEN COOL GREY	40
NEOPRENE VEST YOUTH BLACK	23
NEOPRENE VEST YOUTH BLUE	25
NEOPRENE VEST YOUTH HOT PINK	22
NEOPRENE VEST YOUTH LIME GREEN	24
NEOPRENE VEST YOUTH RED	26
NYLON VEST WOMEN HOT PINK	34
NYLON VEST WOMEN INDIGO BLUE	35
NYLON VEST YOUTH BLUE	19
NYLON VEST YOUTH HOT PINK	17
NYLON VEST YOUTH LIME GREEN	20
NYLON VEST YOUTH RED	18
PET VEST RED	65
SEGMENTED VEST MEN ARMY GREEN	51
SEGMENTED VEST MEN DARK TEAL	52
UNIFY VEST MEN ARMY GREEN	54
UNIFY VEST MEN BLACK	53
UNIFY VEST MEN DARK TEAL	55
UNIFY VEST MEN LIME GREEN	58
UNIFY VEST MEN MARBLE GREEN	56
UNIFY VEST MEN RED	57
UNIFY VEST WOMEN BLACK	42
UNIFY VEST WOMEN DARK TEAL	45
UNIFY VEST WOMEN HOT PINK	43
UNIFY VEST WOMEN INDIGO BLUE	44
UNIVERSAL PACKAGE	30
UNIVERSAL VEST BLUE	28
UNIVERSAL VEST LIME GREEN	29
UNIVERSAL VEST RED	27

## WETSUITS

<b>TECH</b>	<b>68</b>
<b>SIZING</b>	<b>69</b>
ASPEN FULLSUIT CHESTZIP 5/3MM	108
ATLANTA FULLSUIT 2MM	110
ATLANTA SHORTY 2MM	84
BOSTON FULLSUIT 3/2MM ARMY GREEN	93

BOSTON FULLSUIT 3/2MM BLUE	92
BOSTON FULLSUIT 3/2MM HOT PINK	90
BOSTON SHORTY 2MM ARMY GREEN	75
BOSTON SHORTY 2MM BLUE	74
BOSTON SHORTY 2MM HOT PINK	72
BOSTON SHORTY 2MM RED	73
MALMÖ FULLSUIT 5/3MM	94
NEOPRENE JACKET	121
NEOPRENE SHORT	82
PERTH FULLSUIT 3/2MM BLUE	112
PERTH FULLSUIT 3/2MM GRAPHITE GREY	113
PERTH FULLSUIT 3/2MM RED	111
PERTH FULLSUIT CHESTZIP 3/2MM	116
PERTH SHORTY 1.5MM	83
PERTH SHORTY 3/2MM ARMY GREEN	88
PERTH SHORTY 3/2MM BLUE	86
PERTH SHORTY 3/2MM GRAPHITE GREY	89
PERTH SHORTY 3/2MM LIME GREEN	87
PERTH SHORTY 3/2MM RED	85
PORTLAND FULLSUIT 3/2MM	117
PORTLAND FULLSUIT CHESTZIP 3/2MM	118
PORTO JACKET 2MM	102
PORTO LONG JOHN 2MM	101
SAVANNAH FULLSUIT 2MM	96
SAVANNAH SHORTY 2MM	78
SOFIA FULLSUIT 3/2MM DARK TEAL	103
SOFIA FULLSUIT 3/2MM HOT PINK	104
SOFIA FULLSUIT 3/2MM INDIGO BLUE	105
SOFIA SHORTY 1.5MM	77
SOFIA SHORTY 3/2MM HOT PINK	79
SOFIA SHORTY 3/2MM INDIGO BLUE	80
SOFIA SHORTY LONGSLEEVE 3/2MM BLACK	81
SOFIA SHORTY SHORT 2MM	76
TORONTO JACKET 2MM	115
TORONTO LONG JOHN 2MM	114
VERONA LEGGING 1.5MM REVERSIBLE INDIGO BLUE	99
VERONA REVERSIBLE LEGGING 1.5MM BLACK	97
VERONA TOP 1.5MM BLACK	98
VERONA TOP 1.5MM INDIGO BLUE	100
VICTORIA FULLSUIT 3/2MM REVERSIBLE	107
VICTORIA FULLSUIT CHESTZIP 3/2MM	106
YUKON FULLSUIT 4/3MM	119
YUKON FULLSUIT CHESTZIP 5/3MM	120

## FOOTWEAR

<b>SIZING</b>	<b>124</b>
AQUA SHOES ADULT	127
DISCOVER SLIP-ON NERO	131
DISCOVER SLIP-ON TEAL	130
DISCOVER SNEAKER HIGH TEAL	134
DISCOVER SNEAKER HIGH NERO	135
AQUA SHOES YOUTH	126
DISCOVER SNEAKER NERO	133
DISCOVER SNEAKER TEAL	132
H2O SHOES 2MM YOUTH	128
H2O SHOES 3MM GBS ADULT	129

## ACCESSORIES

<b>SIZING</b>	<b>124</b>
BACK SUPPORT	139
MULTI PURPOSE REPAIR KIT	577
KNEEBRACE	138
NEOPRENE SOCKS	136
SPRAY LEG	137

## SWIMWEAR

<b>SIZING</b>	<b>142</b>
BOARDSHORT GIRLS TEAL BLUE	154
BOARDSHORT MEN BLACK	164
BOARDSHORT MEN STONE BLUE	163
BOARDSHORTS WOMEN BLACK	159
BOARDSHORTS WOMEN BORDEAUX RED	158
RASHGUARD BOYS	144
RASHGUARD GIRLS	143
RASHGUARD LONGSLEEVE MEN	153
RASHGUARD LOOSE FIT MEN GRAPHITE	152
RASHGUARD MEN BLACK	150
RASHGUARD MEN WHITE	151
RASHGUARD SHORTSLEEVE MEN DARK TEAL	149
RASHGUARD SHORTSLEEVE WOMEN V-NECK	145
RASHGUARD WOMEN BLACK	147
RASHGUARD WOMEN WHITE	146
SWIMSHORT BOY'S BLUE	155
SWIMSHORT MEN COBALT BLUE	160
SWIMSHORT MEN GRAPHITE GREY	162
SWIMSHORT MEN SUNNY LIME GREEN	161
SWIMSHORT WOMEN	157

## DISCOVER CLOTHING

DISCOVER HOODIE MEN BLACK	183
DISCOVER HOODIE MEN DARK TEAL	184
DISCOVER HOODIE WOMEN BLACK	174
DISCOVER HOODIE WOMEN BORDEAUX RED	175
DISCOVER LEGGING WOMEN GREEN MARBLE	173
DISCOVER SHORT MEN ARMY GREEN	181
DISCOVER SHORT MEN DENIM BLUE	182
DISCOVER SHORT WOMEN ARMY GREEN	171
DISCOVER SHORT WOMEN DENIM BLUE	170
DISCOVER SPORTSTOP WOMEN BLACK	167
DISCOVER T-SHIRT MEN BLUE	180
DISCOVER T-SHIRT MEN DARK GREY	178
DISCOVER T-SHIRT MEN LIGHT GREY	179
DISCOVER T-SHIRT WOMEN BLUE	172
DISCOVER T-SHIRT WOMEN DARK GREY	168
DISCOVER T-SHIRT WOMEN LIGHT GREY	169
DISCOVER WINDJACKET MEN BLACK	185
DISCOVER WINDJACKET MEN BORDEAUX RED	186
DISCOVER WINDJACKET WOMEN BLACK	176
DISCOVER WINDJACKET WOMEN BORDEAUX RED	177

## CASUAL WEAR

CASUAL LOGO T-SHIRT MEN BLACK	188
CASUAL LOGO T-SHIRT MEN GREY	190
CASUAL T-SHIRT MEN WHITE	189
CASUAL T-SHIRT MEN ARMY GREEN	192
CASUAL T-SHIRT MEN DARK GREY	191
CASUAL T-SHIRT WOMEN	194
JOBE BEAM FLOATABLE GLASSES BLACK-GREEN	198
JOBE BEAM FLOATABLE GLASSES BLACK-SMOKE	199
JOBE DIM FLOATABLE GLASSES BLACK-GREEN	202
JOBE DIM FLOATABLE GLASSES BLACK-SMOKE	200
JOBE DIM FLOATABLE GLASSES TORTOISE-SMOKE	201
PONCHO	195

## GLOVES

<b>SIZING</b>	<b>204</b>
GRIP GLOVES MEN	206
GRIP GLOVES WOMEN	207
NEOPRENE GLOVES	209
PALM PROTECTORS	210
STREAM GLOVES MEN	205

## PERSONAL WATER CRAFT

<b>SIZING</b>	<b>212</b>
ANCHOR SACK	241
CYPRIS FLOATABLE GLASSES SILVER	239
DETROIT FULLFACE HELMET	233
DETROIT GOGGLE	234
DETROIT JET FULLSUIT PRE-SHAPED ARMOR 3/2MM	227
DRYSUIT	228
DUAL JET VEST	213
GOGGLES BLACK	235
KNOX FLOATABLE GLASSES BLACK	236
KNOX FLOATABLE GLASSES BLUE	237
KNOX FLOATABLE GLASSES SILVER	240
KNOX FLOATABLE GLASSES WHITE	238
NEOPRENE BOOTS BLACK	230
NEOPRENE JET VEST MEN	215
NEOPRENE JET VEST WOMEN	214
PORTO JET JACKET 2MM	220
PORTO JET LONG JOHN 2MM	219
SEGMENTED JET VEST BACKSUPPORT MEN	216
SIDE ENTRY JET VEST MEN	217
SUCTION GLOVES MEN	232
TORONTO JET JACKET 2MM SIDEZIP	224
TORONTO JET JACKET FRONTZIP 2MM	226
TORONTO JET LONG JOHN 2MM	225
TORONTO JET LONG JOHN 2MM SHINPROTECTOR	221
WATERPROOF GADGET BAG	231
WRIST SEAL	242

# INDEX

## STAND UP PADDLING

<b>AERO TECH</b>	<b>244</b>
<b>AERO SIZING</b>	<b>245</b>
<b>TITAN TECH</b>	<b>256</b>
<b>TITAN SIZING</b>	<b>257</b>
<b>BAMBOO TECH</b>	<b>262</b>
<b>BAMBOO SIZING</b>	<b>263</b>

ADDICT SUP BOAT RACK	269
ADDICT SUP BOAT RACK CLAMPS	270
AERO CENTER SUP FIN	299
AERO DESNA SUP BOARD 10.0 PACKAGE	246
AERO DUNA SUP BOARD 11.6 PACKAGE	249
AERO HARBOR SUP DOCK	255
AERO LENA SUP BOARD 10.6 YOGA PACKAGE	248
AERO NEVA SUP BOARD 12.6 PACKAGE	250
AERO SUP REPAIR KIT	303
AERO SUP <sup>ERSIZED</sup> SUP BOARD 15.0	254
AERO VENTA 9.6 PACKAGE + SUP SAIL 3,5 M2	251
AERO VENTA SUP BOARD 9.6 PACKAGE	252
AERO VENTA SUP SAIL 3,5 M2	253
AERO YARRA SUP BOARD 10.6 PACKAGE	247
ALUMINIUM PADDLE 3 PCS.	271
BAMBOO ANGARA SUP BOARD 12.6	268
BAMBOO PARANA SUP BOARD 11.6	267
BAMBOO SONORA SUP BOARD 10.6 YOGA	266
BAMBOO VENTURA SUP BOARD 10.6	265
BAMBOO VIZELA SUP BOARD 9.4	264
CARBON PRO PADDLE 2 PCS.	278
CARBON PRO PADDLE 3 PCS. - PADDLE BAG	280
CARBON PRO PADDLE 3 PCS.	279
FCS CENTER SUP FIN 9"	301
FCS TOURING SUP FIN 9"	300
FIBERGLASS PADDLE 3 PCS. BLACK	276
FIBERGLASS PADDLE 3 PCS. BLUE	274
FIBERGLASS PADDLE 3 PCS. TEAL	275
FREEDOM STICK 3 PCS.	273
FREEDOM STICK YOUTH	272
HALKEY ROBERTS VALVE	304
PADDLE BAMBOO CLASSIC	277
SUP CART	295
SUP FIN 6" SET 3 PCS.	302
SUP LEASH 9FT	296
SUP LEASH COIL 10FT	297
TITAN ARAS SUP BOARD 8.6	258
TITAN KAMA SUP BOARD 11.6	260
TITAN KURA SUP BOARD 10.6	259
WEBBING BUNGEE DOCK TIE	298

## COMBO SKI

<b>SIZING</b>	<b>306</b>
ALLEGRE 59" COMBO SKIS RED PACKAGE	309
ALLEGRE 67" COMBO SKIS BLUE PACKAGE	311
ALLEGRE 67" COMBO SKIS LIME GREEN PACKAGE	312
ALLEGRE 67" COMBO SKIS RED PACKAGE	310
ALLEGRE COMBO SKIS BLUE	315

ALLEGRE COMBO SKIS LIME GREEN	316
ALLEGRE COMBO SKIS RED	314
BUZZ TRAINERS WATERSKIS	307
COMBO FIN	320
FIN TRAINER HIGH INCL. SCREWS	320
FIN TRAINER LOW INCL. SCREWS	320
FRONT TOE ADULT	320
FRONT TOE JUNIOR	320
FRONT TOE TRAINER	320
HEMI COMBO SKIS	317
HEMI TRAINERS	308
MODE COMBO SKIS	318
SLALOM TOE ADULT	320
SLALOM TOE JUNIOR	320
SQUEEZE HEEL ADULT	320
SQUEEZE HEEL JUNIOR	320
SQUEEZE HEEL TRAINER	320
STABILIZING BAR JUNIOR	320
STABILIZING BAR STANDARD	320

## SLALOM SKI

<b>SIZING</b>	<b>322</b>
BARON SLALOM SKI	324
COMFORT SLALOM BINDING	326
FOCUS SLALOM BINDING	325
MODE SLALOM SKI	323
RTP ADJUSTABLE NYLON	327
RTP ALUMINIUM	328

## WAKEBOARD

<b>WAKEBOARD TECH</b>	<b>345 - 346</b>
<b>NITRO BINDING TECH</b>	<b>362</b>
<b>DRIFT BINDING TECH</b>	<b>401 - 402</b>
<b>SIZING</b>	<b>347</b>
ARMADA 137 & DRIFT SET	436
ARMADA 137 & HOST SET	422
ARMADA WAKEBOARD SERIES	448
CONCORD 137 & DRIFT SET	437
CONCORD 137 & NITRO SET	423
CONCORD 141 & DRIFT SET	438
CONCORD 141 & NITRO SET	424
CONCORD 145 & DRIFT SET	439
CONCORD 145 & NITRO SET	425
CONCORD WAKEBOARD SERIES	449
CONFLICT 127 & DRIFT SET	442
CONFLICT 134 & DRIFT SET	443
CONFLICT 134 & NITRO SET	428
CONFLICT 138 & DRIFT SET	444
CONFLICT 138 & NITRO SET	429
CONFLICT 142 & DRIFT SET	445
CONFLICT 142 & NITRO SET	430
CONFLICT 145 & DRIFT SET	446
CONFLICT 145 & NITRO SET	431
CONFLICT WAKEBOARD SERIES	451

DRIFT WAKEBOARD BINDINGS	464
DRIFT WAKEBOARD BINDING SKIN	465
DRIFT WAKEBOARD SNEAKERS	462
EVO ADAPTER SET	463
HOST WAKEBOARD BINDINGS BLACK	459
HOST WAKEBOARD BINDINGS BLUE	457
HOST WAKEBOARD BINDINGS PINK	458
JINX WAKEBOARD PACKAGE 128	348
KNOX 139 & REPUBLIK SET	390
KNOX 143 & REPUBLIK SET	391
KNOX PREMIUM 139 & DRIFT SET	407
KNOX PREMIUM 139 & NITRO SET	392
KNOX PREMIUM 139 & NITRO SET	398
KNOX PREMIUM 143 & DRIFT SET	408
KNOX PREMIUM 143 & NITRO SET	393
KNOX PREMIUM 143 & NITRO SET	399
KNOX WAKEBOARD	415
KNOX WAKEBOARD PREMIUM	418
LOGO 138 & MAZE PACKAGE	349
LOGO 138 & MAZE SET	363
LOGO 138 & UNIT PACKAGE	353
LOGO 138 & UNIT SET	367
LOGO SERIES WAKEBOARD	410
MADDOX 138 & NITRO SET	388
MADDOX 138 & REPUBLIK SET	383
MADDOX 138 & UNIT SET	381
MADDOX 142 & NITRO SET	389
MADDOX 142 & REPUBLIK SET	384
MADDOX 142 & UNIT SET	382
MADDOX PREMIUM 138 & DRIFT SET	405
MADDOX PREMIUM 138 & NITRO SET	396
MADDOX PREMIUM 142 & DRIFT SET	406
MADDOX PREMIUM 142 & NITRO SET	397
MADDOX WAKEBOARD	414
MADDOX WAKEBOARD PREMIUM	417
MAZE WAKEBOARD BINDINGS	454
NITRO WAKEBOARD BINDINGS BLACK	460
NITRO WAKEBOARD BINDINGS COOL GREY	461
PITCH 136 & DRIFT SET	433
PITCH 136 & NITRO SET	419
PITCH 140 & DRIFT SET	434
PITCH 140 & NITRO SET	420
PITCH 144 & DRIFT SET	435
PITCH 144 & NITRO SET	421
PITCH WAKEBOARD SERIES	447
PROLIX 134 & HOST SET	385
PROLIX 134 & UNIT SET	378
PROLIX 138 & HOST SET	386
PROLIX 138 & UNIT SET	379
PROLIX 143 & HOST SET	387
PROLIX 143 & UNIT SET	380
PROLIX PREMIUM 138 & DRIFT SET	403
PROLIX PREMIUM 138 & NITRO SET	394
PROLIX PREMIUM 143 & DRIFT SET	404
PROLIX PREMIUM 143 & NITRO SET	395
PROLIX WAKEBOARD	413
PROLIX WAKEBOARD PREMIUM	416
RELOAD 144 & DRIFT SET	440
RELOAD 144 & NITRO SET	426
RELOAD 147 & DRIFT SET	441

RELOAD 147 & NITRO SET	427
RELOAD WAKEBOARD SERIES	450
REPUBLIK WAKEBOARD BINDINGS	456
UNIT WAKEBOARD BINDINGS	455
VANITY 131 & HOST SET	373
VANITY 131 & MAZE PACKAGE	350
VANITY 131 & MAZE SET	364
VANITY 131 & UNIT PACKAGE	354
VANITY 131 & UNIT SET	368
VANITY 136 & HOST SET	374
VANITY 136 & MAZE PACKAGE	351
VANITY 136 & MAZE SET	365
VANITY 136 & UNIT PACKAGE	355
VANITY 136 & UNIT SET	369
VANITY 141 & HOST SET	375
VANITY 141 & MAZE PACKAGE	352
VANITY 141 & MAZE SET	366
VANITY 141 & UNIT PACKAGE	356
VANITY 141 & UNIT SET	370
VANITY WAKEBOARD	412
VANITY WAKEBOARD WOMEN	411
VANITY WOMEN 131 & HOST PACKAGE	359
VANITY WOMEN 131 & HOST SET	376
VANITY WOMEN 131 & UNIT PACKAGE	357
VANITY WOMEN 131 & UNIT SET	371
VANITY WOMEN 136 & HOST PACKAGE	360
VANITY WOMEN 136 & HOST SET	377
VANITY WOMEN 136 & UNIT PACKAGE	358
VANITY WOMEN 136 & UNIT SET	372
WAKEBOARD REPAIR KIT	453

## WAKESURF & WAKESKATE

<b>TECH</b>	<b>481</b>
<b>SIZING</b>	<b>478</b>
ACCELERATE WAKESURFER	482
EPEK WAKESURFER	484
EXCEED WAKESKATE	480
SAVAGE WAKESKATE	479
SHADE WAKESURFER	483
WAKESURF FIN SET	486

## HELMETS

<b>SIZING</b>	<b>488</b>
BASE HELMET BLACK	493
BASE HELMET BORDEAUX RED	492
BASE HELMET DARK TEAL	491
BASE HELMET TEAL BLUE	490
VICTOR HELMET BLACK	489

# INDEX

## MULTIPOSITION- & KNEEBOARDS

<b>SIZING</b>	<b>496</b>
CHIPPER MULTI POSITION BOARD WITH HANDLE	505
OMNIA MULTI POSITION BOARD	508
PROPHECY KNEEBOARD	503
SENTRY KNEEBOARD	502
SENTRY KNEEBOARD PACKAGE	499
STAGE KNEEBOARD	504
STIMMEL MULTI POSITION BOARD	507
STREAK KNEEBOARD BLUE	500
STREAK KNEEBOARD BLUE PACKAGE	497
STREAK KNEEBOARD RED	501
STREAK KNEEBOARD RED PACKAGE	498

## TOWABLES

<b>TECH</b>	<b>514</b>
AIRSTREAM TOWABLE 2P	537
AIRSTREAM TOWABLE 3P	548
AIRSTREAM TOWABLE 4P	555
ANURA TOWABLE 1P	527
ANURA TOWABLE 2P	538
ANURA TOWABLE 3P	549
BINAR TOWABLE 2P	540
BREEZE TOWABLE 1P	524
BUCKLE CONNECTOR	566
CHASER TOWABLE 2P	534
CHASER TOWABLE 3P	544
CHASER TOWABLE 4P	554
CRUSHER TOWABLE 1P	522
DOUBLE TROUBLE TOWABLE 2P	531
GIANT TOWABLE 3P	542
HOTSEAT TOWABLE 1P	525
HYDRA TOWABLE 1P	523
HYDRA TOWABLE PACKAGE 1P	518
KICK FLIP TOWABLE 2P	536
LUNAR TOWABLE 3P	551
PARROT TRAINER TOWABLE 1P	515
REVOLVE TOWABLE 1P	528
REVOLVE TOWABLE 2P	539
REVOLVE TOWABLE 3P	550
RUMBLE TOWABLE 1P	520
RUMBLE TOWABLE PACKAGE 1P	516
SCOUT TOWABLE 2P	535
SCOUT TOWABLE 3P	546
SEA-ESTA TOWABLE 3P	552
SONAR TOWABLE 4P	556
STORM TOWABLE 2P	533
SUNRAY TOWABLE 1P	526
THUNDER TOWABLE 1P	521
THUNDER TOWABLE PACKAGE 1P	517
TORNADO TOWABLE 3P	545
TOWABLE REPAIR KIT	577
TRIBAL II TOWABLE 2P	532
TRIBAL TOWABLE 3P	547
TRIPLET TOWABLE 3P	543
WINGMAN TOWABLE 1P	529

## OCEAN RIDERS

MULTI RIDER REPAIR KIT	582
WATERSLED 3P	578
WATERSLED 5P	579
WATERSLED 6P	580
WATERSLED 8P	581

## LEISURE MUSTHAVES

BODYBOARD LEASH COIL	589
BODYBOARD LEASH STRAIGHT	590
CLAPPER BODYBOARD	586
DIPPER BODYBOARD	585
SHOVI T SKIMBOARD	588
WATER CARPET	584

## BOATING ACCESSORIES

1.1 TOWER PACKAGE (SET)	592
1.3 TOWER PACKAGE (SET)	593
2.0 TOWER PACKAGE (SET)	594
ADDICT BOAT BIMINI	600
ADDICT BULLET SPEAKERS	606
ADDICT CURVED MIRROR ARM WITH MIRROR	601
ADDICT FORWARD TOWER 2.0	598
ADDICT LED LIGHT BAR	607
ADDICT PIVOTING SWIVEL BOARD RACK	605
ADDICT RACK CLAMP ANODIZED 1.875"-2"	610
ADDICT RACK CLAMP ANODIZED 2.25"-2.5"	611
ADDICT RACK CLAMP POLISHED 1.875"-2"	608
ADDICT RACK CLAMP POLISHED 2.25"-2.5"	609
ADDICT SWIVEL BOARD RACK	602
ADDICT SWIVEL WATERSKI RACK	603
ADDICT TOWER 1.1	596
ADDICT TOWER 1.3	597
ADDICT TOWER BIMINI	599
ADDICT WAKEBOARD/KNEEBOARD RACK	604
BOAT MIRROR	615
CONTOUR FENDER BLACK	613
EMERGENCY CORD	614
SAFETY MIRROR	617
SLALOM BUOY GREEN	620
SLALOM BUOY ORANGE	618
SLALOM BUOY YELLOW	619
SUCTION CUP MIRROR	616
WEBBING BUNGEE DOCK TIE	612

## HEAVY DUTY

<b>TECH</b>	<b>623 - 627</b>
<b>SIZING</b>	<b>622</b>
HD WAKEBOARD TIP/TAIL PROTECTORS	655
HEAVY DUTY AIRSTREAM TOWABLE 4P	641
HEAVY DUTY COMBO FIN WITH SCREWS SET	651
HEAVY DUTY COMBO SKIS ADULT	650

HEAVY DUTY COMBO SKIS YOUTH	649
HEAVY DUTY COMBO WATERSKIS END CAPS	651
HEAVY DUTY FRONT TOE	651
HEAVY DUTY FULLSUITS 3/2.5MM	635
HEAVY DUTY FULLSUITS 5/3MM	636
HEAVY DUTY FULLSUITS 5/3MM YOUTH	633
HEAVY DUTY HARDSHELL HELMET YELLOW	656
HEAVY DUTY HOTSEAT TOWABLE 1P	638
HEAVY DUTY MONITEUR VEST	632
HEAVY DUTY MULTI RIDER 10P	647
HEAVY DUTY MULTI RIDER 10P DOUBLE	648
HEAVY DUTY MULTI RIDER 6P	645
HEAVY DUTY MULTI RIDER 8P	646
HEAVY DUTY SHIELD TOWABLE 4P	640
HEAVY DUTY SHORTY 2.5/2MM	634
HEAVY DUTY SIGMA TOWABLE 6P	642
HEAVY DUTY SOFTSHELL HELMET RED	657
HEAVY DUTY SOFTSHELL HELMET YELLOW	658
HEAVY DUTY SONAR TOWABLE 4P	643
HEAVY DUTY SONAR TOWABLE 6P	644
HEAVY DUTY SQUEEZE HEEL	651
HEAVY DUTY STANDING BUOY	629
HEAVY DUTY TRIBAL TOWABLE 2P	639
HEAVY DUTY VEST RED	630
HEAVY DUTY VEST YELLOW	631
HEAVY DUTY WAKEBOARD	654
HEAVY DUTY WAKEBOARD BINDINGS	652

## ROPES & HANDLES

15" EASY UP DEEP V DELUXE	337
BUNGEE EXTENSION	572
BUNGEE ROPE	573
CABLE BRIDLE STAINLESS HOOKS 8FT 1P	341
CHIPPER HANDLE	506
DOG LEASH	66
ELITE WAKE COMBO	471
FRONTIER WAKE HANDLE	472
MAGNUM BRIDLE 8FT 4P	565
PRIME WAKE COMBO BLUE	469
PRIME WAKE COMBO RED	468
PRIME WAKE COMBO YELLOW	470
QUICK RELEASE WITH WRIST SEAL	574
ROPE BRIDLE STAINLESS HOOKS 12FT 1P	339
SKI FLAG FLAME ORANGE	342
SPECTRA WAKE ROPE PVC COATED	473
SPORT SERIES 2 SECTION	335
SPORT SERIES 8 SECTION	336
TOW HOOK HANDLE	509
TOWROPE 2P	568
TOWROPE 4P	569
TOWROPE 6P	570
TOWROPE 10P	571
TRANSFER SKI COMBO BLUE	332
TRANSFER SKI COMBO RED	333
TRANSFER SKI COMBO GREEN	334
WAKESURF ROPE	485
WATERSPORTS BRIDLE WITHOUT PULLEY 8FT 2P	338
WATERSPORTS BRIDLE WITH PULLEY 12FT 2P	340

## BAGS

ALL-IN ONE PADDLE BAG	290
BACKPACK	197
BASIC WAKEBOARD BAG	474
COMBO WATERSKIS BAG	319
DRYBAG 10L	292
DRYBAG 20L	293
DRYBAG 40L	294
MULTI POSITION BOARD BAG	510
NEOPRENE SLALOM BAG	329
PADDED SLALOM BAG	330
PADDED WAKEBOARD BAG	475
SUP BAG 9.4	286
SUP BAG 10.6	287
SUP BAG 11.6	288
SUP BAG 12.6	289
TUBE BAG 1-2P	575
TUBE BAG 3-5P	576
WET GEAR BAG	125
WAKEBOARD TRAILER BAG	476
WATERPROOF GADGET BAG	291

## PUMPS

AIR PUMP 12V	560
AIR PUMP 230V	562
AIR PUMP WITH UK PLUG 230V	561
COMPRESSOR ADAPTOR	577
FOOT PUMP	558
HAND PUMP DOUBLE ACTION	559
HEAVY DUTY PUMP	564
PORTABLE ELECTRIC AIR PUMP	285
SUP PUMP DOUBLE ACTION 27 PSI	282
SUP PUMP 12V	284
TRIPLE ACTION SUP PUMP	283
TURBO PUMP 12V	563

## INSTORE PROMOTION

INSTORE PROMOTION	659 - 667
-------------------	-----------

# 24/7 JOE

## THE ONLINE DEALER PORTAL

### **ORDERING**

- *PRODUCT INFORMATION AND PRICING*
- *SPECIAL OFFERS*
- *LIVE STOCK VIEW*

### **NEWS**

- *LAB*
- *BLOG*

### **CUSTOMER SERVICE**

- *INVOICE HISTORY*
- *WARRANTIES*
- *TRACK & TRACE*

### **TOOLS & SUPPORT**

- *MARKETING TOOLS*
- *TERMS AND CONDITIONS*

### **JOBE ACADEMY**

- *ONLINE TRAINING TOOL*
- *THEORY, VIDEO'S AND EXAMS*

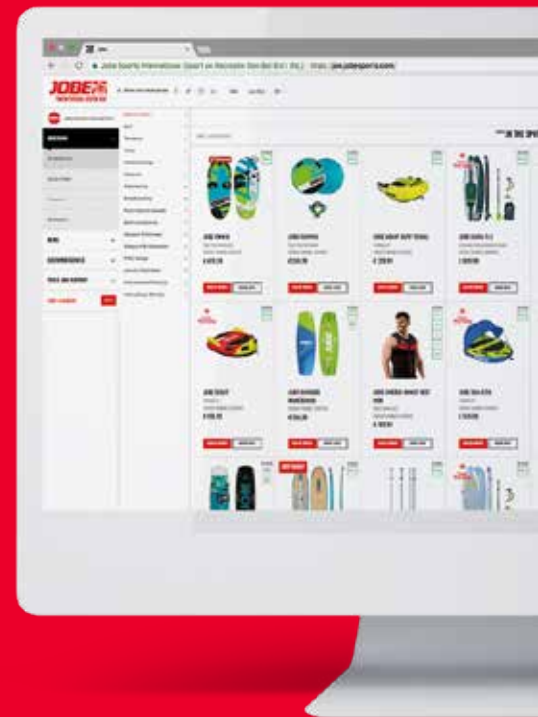

# WHY BUY JOBE?

*JOBE SPORTS INTERNATIONAL IS THE MOST COMPREHENSIVE WATER SPORTS BRAND IN THE WORLD. JOBE OFFERS A WIDE RANGE OF PRODUCTS MADE BY WATERSPORT PEOPLE FOR WATERSPORT PEOPLE.*

## **POSITIONING**

*Jobe is positioned in a unique way into the market. We expect the best quality from our products and do not settle for less. In addition, we find it important that our products are accessible, both in price and use. One of the characteristics of Jobe's products is the attention to detail. Everything about a Jobe product is an experience. From the moment the customer enters the store, unpacks and uses the product, it all adds up to the customer's experience.*

## **3 YEARS WARRANTY**

*We strive to be the best, our developers work day and night to deliver the highest quality possible for our products. To share this with our consumers, we decided to provide a 3-year warranty on ALL our towables and inflatable sup boards! With this new and unique warranty, we want to show the world how much we trust in our products!*

## **BRANDCODE**

*The brandcode helps you with the understandable question "How to communicate as an internationally acknowledged brand without losing our personal identity, in both our internal as external communication?" The brandcode consists of seven keywords; FUN, ACCESIBLE, ENTHOUSIASTIC, INNOVATIVE, YOUNG, SPECIALIST and INTERNATIONAL. We believe in these seven keywords, that's why the brandcode comes back in our communication, products and trading.*

## **MIX AND MATCH**

*One of the unique things that we offer is the Mix & Match concept. Combinations can be made throughout all of our segments. A wakeboard can be mixed with a vest, a towable with casual clothing or sneakers with a wetsuit. Anything is possible, all combinations are possible! We are the only brand that offers this unique concept and we are proud of it.*



# WHY BUY HERE?

AS A RETAILER, YOU WANT TO ATTRACT AS MANY CONSUMERS AS POSSIBLE.  
BUT WHY DOES A CONSUMER WANT TO BUY IN YOUR SHOP?  
JOBE IS PROVIDING YOU THE SALES TOOLS TO HELP YOU ANSWER THAT QUESTION.

## APPEARANCE

Whether you are selling online or offline, the appearance of the sales outlet is an important factor of success. We believe it is important that our retailers are given the resources to set up the store with the right image. For this we have created an Instore Presence program. With our Instore Presence philosophy, consumers are helped to make a choice. The results have shown that a good instore presence can lead to a significant increase in sales.

## SPECIALIST

In addition to a good instore presence, we find it important that our consumers receive the best advice. That is why we launched the Jobe Academy. The Jobe Academy is a sales tool where retailers are trained to become specialists. The course consists of a theoretical text, product videos by the product developers themselves and is topped off with a quiz. Jobe dealers will get instructions about Jobe products, the Jobe dealer portal and their marketing activities. When a retailer completes the course, the status "Jobe Specialist" will be rewarded.









# WE LOVE WATERSPORTS

*Remember that day, when you first strapped into a pair of bindings, sat down on a tube or paddled out on the water? We do! And it's the reason we wake up every morning and get out of bed with huge smile on our face.*

*To say that we love watersports here at Jobe Sports would be an understatement... We live for watersports! Whether we get out on the water behind the boat, explore nature's waterways on a SUP or land a trick on a wakeboard. Each and every one of us here at Jobe has a passion for watersports which resonates with our crew and the company.*

*With a crew so passionate about watersports, our mission statement won't come as a surprise to you. Our mission statement is: Getting as many people on the water, who can enhance their performance at any level with Jobe products. A Fun mission statement and we're Enthusiastic to get everyone out on the water! How do we do that you ask? We make Innovative products that are Accessible for any level. And being the Young company Jobe Sports is, we always strive to be a Specialist in all our segments on an International scale.*

*So in what segments are we active? Boating is where you can find our roots and is what we're known for. We produce everything for Boating (except the boat itself) like: Towables, ropes, towers and more. You'll never have to say no to a boating customer with a range of Jobe products. But maybe you have an extreme customer, that's where our wakeboard products kick in! We make some of the best wakeboards and bindings out there, which are perfect for every wakeboard fanatic. But nowadays, SUP (Stand Up Paddling) is what it's all about. It's the fastest growing watersport to date and Jobe is on the forefront of this sport. We make high-end SUP boards, paddles and clothing, which will appeal to any customer. But when your customer has the right products, you want to*

*set them up right. That's why we have some innovative neoprene softgoods, which your customer can mix and match. Your customer will always have the best suit when he or she is wearing a Jobe wetsuits!*

*We make sure we have all the knowledge in-house here at Jobe Sports. Our Product Development team guarantees new products which are of the highest quality. And our creative team of Product Design is a team of modern day Da Vinci's, who have an eye for detail. A skilled Purchase team, forecasts product purchases 11 times a year! While working with over 50 suppliers on a daily base. To make sure this is all being communicated well, we have our own marketing team. Who produce great and new content every day, which is then communicated through Social Media and different media partners. While also working intensely with all our Jobe athletes, who fit our brand and who are ambassadors for their sport. The marketing team works closely with our Sales team, who operate in more than a 100 countries! Yeah we know, that's a lot! Can you even name a 100 countries from the top of your head? And as if that wasn't enough, our Sales team has a global network with over 3000 dealers. With so many dealers you need people who can keep things organized, that's where Finance saves the day. The Finance crew processes all the invoices and invests in automation and Joe to make everyone's life easier. Have you met Joe by the way? He is our go to guy when it comes to the ordering process for dealers and is fully automated. Last but definitely not least, there are the guys and girls of our 3750 square meter warehouse, who pick, pack and send out all orders!*

*No matter what you want to do on the water, we got you covered and make sure you'll have a ton of fun while doing so. So put on a wetsuit, get out your wakeboard, sit down on a towable, paddle out on your SUP, meet up with your friends and family and get out on the water and have some fun!*





**JOBES** ★

JOBES



**VESTS**

# VEST TECHNOLOGY

POLYESTER FABRIC  
SOFT AND HIGH STRETCH

CR CLOSED CELL FOAM  
WATERPROOF

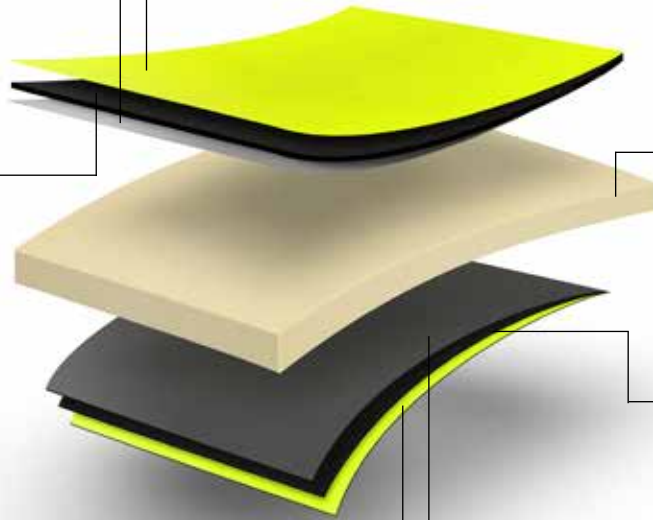

PVC FOAM  
COMFORTABLE AND SOFT

CR CLOSED CELL FOAM  
WATERPROOF

POLYESTER FABRIC  
SOFT AND HIGH STRETCH

NYLON FABRIC  
LIGHTWEIGHT AND QUICKDRY

EPE FOAM  
LIGHTWEIGHT

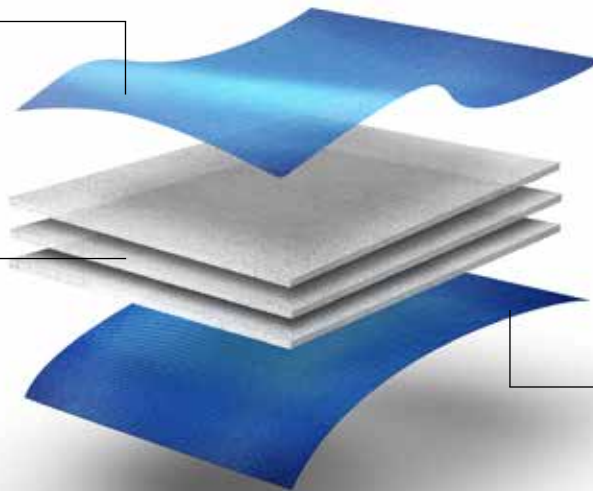

NYLON FABRIC  
LIGHTWEIGHT AND QUICKDRY

# SIZING VESTS

## OUR NEW VEST SIZING

Let's be honest: you don't want to save on safety. In 2017 we introduce improved vest sizing for optimal comfort, performance and safety. Due to reduced differences between sizes we've more sizes in our ranges and a perfect fitting for every body type. Innovations that will contribute to your safety, without compromising on comfort. Vests with the new sizing now have a unique Jobe certificate. Have a carefree ride.

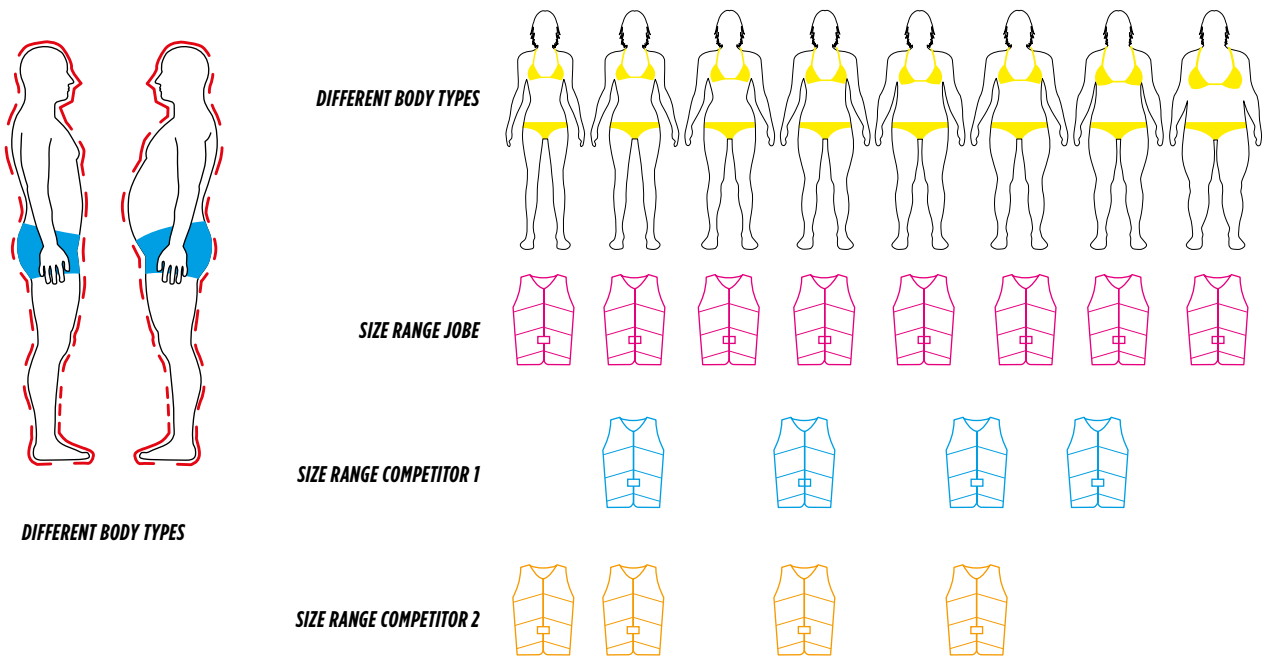

DIFFERENT BODY TYPES

DIFFERENT BODY TYPES

SIZE RANGE JOBE

SIZE RANGE COMPETITOR 1

SIZE RANGE COMPETITOR 2

## HOW TO MEASURE

### 1. CHEST

Place the tape close under the arms. Measure the chest at the widest part.

### 2. WAIST

Measure around the natural waistline.

### 3. HEIGHT

Measure from your head until your feet.

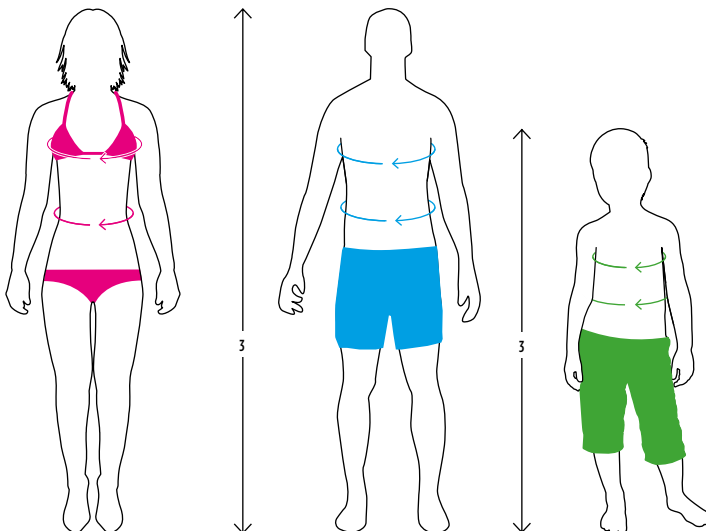

Check our size charts at page 156

# SIZING VESTS

## MEN VESTS

SIZE	UNIFY, SEGMENTED, BACKSUPPORT, NEOPRENE & SIDE ENTRY VEST (CERTIFIED SON)							
	(ATHLETIC FIT)				(+ SIZES LEISURE FIT)			
	CHEST (CM)	CHEST (INCH)	WAIST (CM)	WAIST (INCH)	CHEST (CM)	CHEST (INCH)	WAIST (CM)	WAIST (INCH)
90-94	35,4-37	80-84	31,5-33,1	-	-	-	-	-
XS	94-98	37-38,6	84-88	33,1-34,7	-	-	-	-
S	98-102	38,6-40,2	88-92	34,7-36,2	-	-	-	-
M	102-106	40,2-41,7	92-96	36,2-37,8	-	-	-	-
L	106-110	41,7-43,3	96-100	37,8-39,4	-	-	-	-
XL	-	-	-	-	106-112	41,7-44,1	96-104	37,8-40,9
XL+	-	-	-	-	112-118	44,1-46,5	104-112	40,9-44,1
2XL+	-	-	-	-	118-124	46,5-48,8	112-120	44,1-47,2
3XL+	-	-	-	-	124-130	48,8-51,2	120-128	47,2-50,4
4XL+	-	-	-	-	130-136	51,2-53,5	128-136	50,4-53,5
5XL+	-	-	-	-	-	-	-	-

## WOMEN VESTS

SIZE	UNIFY, NEOPRENE & NYLON VEST (CERTIFIED SON)			
	CHEST (CM)	CHEST (INCH)	WAIST (CM)	WAIST (INCH)
XS	82-86	32,3-33,9	65-69	25,6-27,2
S	86-90	33,9-35,4	70-74	27,6-29,1
S+	90-94	35,4-37	74-78	29,1-30,7
M	94-98	37-38,6	78-82	30,7-32,3
M+	98-102	38,6-40,2	83-87	32,7-34,3
L	102-106	40,2-41,7	87-92	34,3-36,2
XL	107-113	42,1-44,5	93-99	36,6-39
2XL	113-119	44,5-46,9	99-105	39-41,3
3XL	119-125	46,9-49,2	106-112	41,7-44,1

## UNISEX VESTS

SIZE	EASY BOATING VEST (CERTIFIED 100N)					COMFORT BOATING VEST (CERTIFIED 100N)			
	CHEST	CHEST (INCH)	WEIGHT (KG)	WEIGHT (LBS)		CHEST (CM)	CHEST (INCH)	WEIGHT (KG)	WEIGHT (LBS)
S/M	76-114	29,9-44,9	50-60	110,2-132,3	S	70-90	27,6-35,4	40-60	88,2-132,3
L/XL	114-152	44,9-59,8	>60	>132,3	M	80-95	31,5-37,4	60-70	132,3-154,3
					L	90-115	35,4-45,3	70-90	154,3-198,4
					XL	>115	>45,3	>90	>198,4

SIZE	4 BUCKLE VEST (CERTIFIED SON)					DUAL VEST (CERTIFIED SON)			
	CHEST (CM)	CHEST (INCH)	WAIST (CM)	WAIST (INCH)		CHEST (CM)	CHEST (INCH)	WAIST (CM)	WAIST (INCH)
XS	89-95	35-37,4	79-85	31,1-33,5	S/M	94-102	37-40,2	84-92	33,1-36,2
S	93-99	36,6-39	83-89	32,7-35	L/XL	102-110	40,2-43,3	92-100	36,2-39,4
M	97-103	38,2-40,6	87-93	34,3-36,6	2XL/3XL	110-118	43,3-46,5	100-108	39,4-42,5
L	101-107	39,8-42,1	91-97	35,8-38,2	4XL/5XL	118-128	46,5-50,4	108-118	42,5-46,5
XL	105-113	41,3-44,5	95-103	37,4-40,6					
2XL	111-119	43,7-46,9	101-109	39,8-42,9					
3XL	117-125	46,1-49,2	107-115	42,1-45,3					
4XL	123-131	48,4-51,6	113-121	44,5-47,6	UNI	85-125	33,5-49,2	75-115	29,5-45,3

## PET VEST (NON CERTIFIED)

SIZE	WEIGHT (KG)	WEIGHT (LBS)
XS	<7	15,4
S	7-14	15,4-30,9
M	14-27	30,9-59,5

## YOUTH VESTS

SIZE	NEO VEST YOUTH (CERTIFIED SON)				SIZE	NYLON VEST YOUTH (CERTIFIED SON)			
	CHEST (CM)	CHEST (INCH)	WAIST (CM)	WAIST (INCH)		CHEST (CM)	CHEST (INCH)	WAIST (CM)	WAIST (INCH)
6	57-60	22,4-23,6	52-56	20,5-22	UNI	60-70	23,6-27,6	56-64	22-25,2
8	60-64	23,6-25,2	56-59	22-23,2					
10	64-69	25,2-27,2	59-63	23,2-24,8					
12	69-76	27,2-29,9	64-68	25,2-26,8					
14	76-82	29,9-32,3	69-73	27,2-28,7					
16	82-89	32,3-35	74-78	29,1-30,7					

SIZE	NEO SAFETY VEST YOUTH (CERTIFIED 100N)					COMFORT BOATING VEST YOUTH (CERTIFIED 100N)			
	CHEST (CM)	CHEST (INCH)	WEIGHT (KG)	WEIGHT (LBS)		CHEST (CM)	CHEST (INCH)	WEIGHT (KG)	WEIGHT (LBS)
XS/S (INFANT)	40-50	15,7-19,7	<20	<44,1	4XS	<57	<22,4	3-10	6,6-22
M/L (CHILD)	50-60	19,7-23,6	20-30	44,1-66	3XS/2XS	<57	<22,4	10-15	22-33,1
					XS/S	57-65	22,4-25,6	15-20	33,1-44,1
					M/L	60-70	23,6-27,6	20-30	44,1-66,1





► STRONG & LIGHTWEIGHT NYLON FABRIC



► 50N ISO-CERTIFIED (BUOYANCY AID)

**SCRIBBLE VEST**

ITEM NUMBER	EAN CODE	HS CODE	FEATURES
248917009	PCS 8718181236782	63072000	50N ISO-CERTIFIED (BUOYANCY AID) LIGHTWEIGHT PE-FOAM FRONT ZIPPER FOR FAST ENTRY STRONG & LIGHTWEIGHT NYLON FABRIC 1" ADJUSTABLE WEBBING STRAPS (2X) STRONG YKK BUCKLES STRONG YKK ZIPPER WATER DRAINAGE SYSTEM UNISEX FIT CROTCH STRAPS FOR OPTIMAL SAFETY
SIZE	MASTER CARTON INFO		
PCS.	QUANTITY PER M. CARTON:	6	
	M. CARTON WEIGHT (KG):	2,58	
	M. CARTON WEIGHT (LBS):	5,69	
	M. CARTON SIZE (M):	0,6 X 0,4 X 0,4	
	M. CARTON SIZE (INCH):	23,62 X 15,75 X 15,75	





► STRONG YKK BUCKLES



► 50N ISO-CERTIFIED (BUOYANCY AID)

**NYLON VEST YOUTH HOT PINK**

ITEM NUMBER	EAN CODE	HS CODE	FEATURES
244819300	PCS. 8718181001496	63072000	50N ISO-CERTIFIED (BUOYANCY AID) LIGHTWEIGHT PE-FOAM STRONG & LIGHTWEIGHT NYLON FABRIC 1,5" ADJUSTABLE WEBBING STRAPS (3X) STRONG YKK BUCKLES WATER DRAINAGE SYSTEM UNISEX FIT
<b>SIZE</b>		<b>MASTER CARTON INFO</b>	
PCS.		QUANTITY PER M. CARTON: 10 M. CARTON WEIGHT (KG): 4 M. CARTON WEIGHT (LBS): 8,8 M. CARTON SIZE (M): 0,6X0,4X0,5 M. CARTON SIZE (INCH): 23,62X15,75X19,69	



► STRONG YKK BUCKLES



► 50N ISO-CERTIFIED (BUOYANCY AID)

**NYLON VEST YOUTH RED**

ITEM NUMBER	EAN CODE	HS CODE	FEATURES
244817371	PCS. 8718181210492	63072000	50N ISO-CERTIFIED (BUOYANCY AID) LIGHTWEIGHT PE-FOAM STRONG & LIGHTWEIGHT NYLON FABRIC 1,5" ADJUSTABLE WEBBING STRAPS (3X) STRONG YKK BUCKLES WATER DRAINAGE SYSTEM UNISEX FIT
<b>SIZE</b>		<b>MASTER CARTON INFO</b>	
PCS.		QUANTITY PER M. CARTON: 10 M. CARTON WEIGHT (KG): 4 M. CARTON WEIGHT (LBS): 8,8 M. CARTON SIZE (M): 0,6X0,4X0,5 M. CARTON SIZE (INCH): 23,62X15,75X19,69	



► STRONG YKK BUCKLES



► 50N ISO-CERTIFIED (BUOYANCY AID)

**NYLON VEST YOUTH BLUE**

ITEM NUMBER	EAN CODE	HS CODE	FEATURES
244817370	PCS. 8718181210478	63072000	50N ISO-CERTIFIED (BUOYANCY AID) LIGHTWEIGHT PE-FOAM STRONG & LIGHTWEIGHT NYLON FABRIC 1,5" ADJUSTABLE WEBBING STRAPS (3X) STRONG YKK BUCKLES WATER DRAINAGE SYSTEM UNISEX FIT
<b>SIZE</b>		<b>MASTER CARTON INFO</b>	
PCS.		QUANTITY PER M. CARTON: 10 M. CARTON WEIGHT (KG): 8,25 M. CARTON WEIGHT (LBS): 18,15 M. CARTON SIZE (M): 0,6X0,4X0,5 M. CARTON SIZE (INCH): 23,62X15,75X19,69	



► STRONG YKK BUCKLES



► 50N ISO-CERTIFIED (BUOYANCY AID)

**NYLON VEST YOUTH LIME GREEN**

ITEM NUMBER	EAN CODE	HS CODE	FEATURES
244819301	PCS. 8718181001502	63072000	50N ISO-CERTIFIED (BUOYANCY AID) LIGHTWEIGHT PE-FOAM STRONG & LIGHTWEIGHT NYLON FABRIC 1,5" ADJUSTABLE WEBBING STRAPS (3X) STRONG YKK BUCKLES WATER DRAINAGE SYSTEM UNISEX FIT
<b>SIZE</b>		<b>MASTER CARTON INFO</b>	
PCS.		QUANTITY PER M. CARTON: 10 M. CARTON WEIGHT (KG): 4 M. CARTON WEIGHT (LBS): 8,8 M. CARTON SIZE (M): 0,6X0,4X0,5 M. CARTON SIZE (INCH): 23,62X15,75X19,69	



**NEOPRENE SAFETY VEST YOUTH**

ITEM NUMBER	EAN CODE	HS CODE	FEATURES
244917306	XS/S 8718181242530 M/L 8718181242523	63072000	100N ISO-CERTIFIED (LIFE JACKET) SOFT PVC FOAM FRONT ZIPPER FOR FAST ENTRY SOFT & FLEXIBLE NEOPRENE FABRIC 1" ADJUSTABLE WEBBING STRAPS (2X) STRONG YKK BUCKLES   STRONG YKK ZIPPER WATER DRAINAGE SYSTEM UNISEX FIT CROTCH STRAPS FOR OPTIMAL SAFETY WHISTLE IN CASE OF EMERGENCY BRIGHT COLOR & REFLECTING PANELS FOR OPTIMAL VISIBILITY
<b>SIZE</b>		<b>MASTER CARTON INFO</b>	
XS/S   M/L		QUANTITY PER M. CARTON: 10 M. CARTON WEIGHT (KG): 9,90 M. CARTON WEIGHT (LBS): 21,83 M. CARTON SIZE (M): 0,52 X 0,51 X 0,61 M. CARTON SIZE (INCH): 20,47 X 20,08 X 24,02	

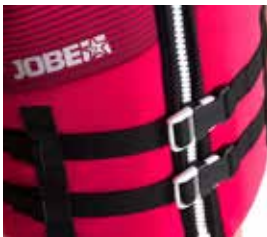

► STRONG YKK BUCKLES



► 1,5" ADJUSTABLE WEBBING STRAPS (2X)



► 50N ISO-CERTIFIED (BUOYANCY AID)

**NEOPRENE VEST YOUTH HOT PINK**

ITEM NUMBER	EAN CODE	HS CODE	FEATURES
244919303	6 8718181003117 8 8718181003100 10 8718181003094	63072000	50N ISO-CERTIFIED (BUOYANCY AID) SOFT PVC FOAM FRONT ZIPPER FOR FAST ENTRY SOFT & FLEXIBLE NEOPRENE FABRIC
<b>SIZE</b>	12 8718181003087 14 8718181021210 16 8718181021227	<b>MASTER CARTON INFO</b>	1,5" ADJUSTABLE WEBBING STRAPS (2X) STRONG YKK BUCKLES STRONG YKK ZIPPER WATER DRAINAGE SYSTEM UNISEX FIT
6   8   10   12   14   16		QUANTITY PER M. CARTON: 10 M. CARTON WEIGHT (KG): 10,3 M. CARTON WEIGHT (LBS): 22,66 M. CARTON SIZE (M): 0,6X0,4X0,42 M. CARTON SIZE (INCH): 23,62X15,75X16,54	



► STRONG YKK BUCKLES



► 1,5" ADJUSTABLE WEBBING STRAPS (2X)



► 50N ISO-CERTIFIED (BUOYANCY AID)

**NEOPRENE VEST YOUTH BLACK**

ITEM NUMBER	EAN CODE	HS CODE	FEATURES
244919300	6 8718181003070 8 8718181003063 10 8718181003056	63072000	50N ISO-CERTIFIED (BUOYANCY AID) SOFT PVC FOAM FRONT ZIPPER FOR FAST ENTRY SOFT & FLEXIBLE NEOPRENE FABRIC
<b>SIZE</b>	12 8718181003049 14 8718181021197 16 8718181021203	<b>MASTER CARTON INFO</b>	1,5" ADJUSTABLE WEBBING STRAPS (2X) STRONG YKK BUCKLES STRONG YKK ZIPPER WATER DRAINAGE SYSTEM UNISEX FIT
6   8   10   12   14   16		QUANTITY PER M. CARTON: 10 M. CARTON WEIGHT (KG): 10,3 M. CARTON WEIGHT (LBS): 22,66 M. CARTON SIZE (M): 0,6X0,4X0,42 M. CARTON SIZE (INCH): 23,62X15,75X16,54	



► STRONG YKK BUCKLES



► 1,5" ADJUSTABLE WEBBING STRAPS (2X)



► 50N ISO-CERTIFIED (BUOYANCY AID)

**NEOPRENE VEST YOUTH LIME GREEN**

ITEM NUMBER	EAN CODE	HS CODE	FEATURES
244919304	6 8718181003155 8 8718181003148 10 8718181003131	63072000	50N ISO-CERTIFIED (BUOYANCY AID) SOFT PVC FOAM FRONT ZIPPER FOR FAST ENTRY
<b>SIZE</b>	12 8718181003124 14 8718181021234 16 8718181021241	<b>MASTER CARTON INFO</b>	SOFT & FLEXIBLE NEOPRENE FABRIC 1,5" ADJUSTABLE WEBBING STRAPS (2X) STRONG YKK BUCKLES STRONG YKK ZIPPER WATER DRAINAGE SYSTEM UNISEX FIT
6   8   10   12   14   16		QUANTITY PER M. CARTON: 10 M. CARTON WEIGHT (KG): 10,3 M. CARTON WEIGHT (LBS): 22,66 M. CARTON SIZE (M): 0,6X0,4X0,42 M. CARTON SIZE (INCH): 23,62X15,75X16,54	





► STRONG YKK BUCKLES



► 1,5" ADJUSTABLE WEBBING STRAPS (2X)



► 50N ISO-CERTIFIED (BUOYANCY AID)

**NEOPRENE VEST YOUTH BLUE**

ITEM NUMBER	EAN CODE	HS CODE	FEATURES
244919305	6 8718181003193 8 8718181003186 10 8718181003179	63072000	50N ISO-CERTIFIED (BUOYANCY AID) SOFT PVC FOAM FRONT ZIPPER FOR FAST ENTRY SOFT & FLEXIBLE NEOPRENE FABRIC
<b>SIZE</b>	12 8718181003162 14 8718181021258 16 8718181021265	<b>MASTER CARTON INFO</b>	1,5" ADJUSTABLE WEBBING STRAPS (2X) STRONG YKK BUCKLES STRONG YKK ZIPPER WATER DRAINAGE SYSTEM UNISEX FIT
6   8   10   12   14   16		QUANTITY PER M. CARTON: 10 M. CARTON WEIGHT (KG): 10,3 M. CARTON WEIGHT (LBS): 22,66 M. CARTON SIZE (M): 0,6X0,4X0,42 M. CARTON SIZE (INCH): 23,62X15,75X16,54	



► STRONG YKK BUCKLES



► 1,5" ADJUSTABLE WEBBING STRAPS (2X)



► 50N ISO-CERTIFIED (BUOYANCY AID)

**NEOPRENE VEST YOUTH RED**

ITEM NUMBER	EAN CODE	HS CODE	FEATURES
244919306	6 8718181003230 8 8718181003223 10 8718181003216 12 8718181003209 14 8718181021272 16 8718181021289	63072000	50N ISO-CERTIFIED (BUOYANCY AID) SOFT PVC FOAM FRONT ZIPPER FOR FAST ENTRY SOFT & FLEXIBLE NEOPRENE FABRIC 1,5" ADJUSTABLE WEBBING STRAPS (2X) STRONG YKK BUCKLES STRONG YKK ZIPPER WATER DRAINAGE SYSTEM UNISEX FIT
<b>SIZE</b>	6   8   10   12   14   16	<b>MASTER CARTON INFO</b>	
		QUANTITY PER M. CARTON: 10 M. CARTON WEIGHT (KG): 10,3 M. CARTON WEIGHT (LBS): 22,66 M. CARTON SIZE (M): 0,6X0,4X0,42 M. CARTON SIZE (INCH): 23,62X15,75X16,54	



► STRONG YKK BUCKLES

**UNIVERSAL VEST RED**

**ITEM NUMBER**

244817578

**EAN CODE**

PCS. 8718181210454

**HS CODE**

63072000

**FEATURES**

50N ISO-CERTIFIED (BUOYANCY AID)  
 LIGHTWEIGHT PE-FOAM  
 STRONG & LIGHTWEIGHT NYLON FABRIC  
 1" ADJUSTABLE WEBBING STRAPS (3X)  
 STRONG YKK BUCKLES  
 ALWAYS A PERFECT FIT: MORE COMFORT AND SAFETY  
 WATER DRAINAGE SYSTEM  
 ADJUSTABLE SIZING DUE TO OPEN SIDES  
 UNISEX FIT

**SIZE**

PCS.

**MASTER CARTON INFO**

QUANTITY PER M. CARTON: 10  
 M. CARTON WEIGHT (KG): 4,9  
 M. CARTON WEIGHT (LBS): 10,78  
 M. CARTON SIZE (M): 0,8X0,6X0,32  
 M. CARTON SIZE (INCH): 31,5X23,62X12,6



► STRONG YKK BUCKLES

**UNIVERSAL VEST BLUE**

ITEM NUMBER	EAN CODE	HS CODE	FEATURES
244817577	PCS. 8718181210409	63072000	50N ISO-CERTIFIED (BUOYANCY AID) LIGHTWEIGHT PE-FOAM STRONG & LIGHTWEIGHT NYLON FABRIC 1" ADJUSTABLE WEBBING STRAPS (3X) STRONG YKK BUCKLES ALWAYS A PERFECT FIT: MORE COMFORT AND SAFETY WATER DRAINAGE SYSTEM ADJUSTABLE SIZING DUE TO OPEN SIDES UNISEX FIT
SIZE	MASTER CARTON INFO		
PCS.	QUANTITY PER M. CARTON:	10	
	M. CARTON WEIGHT (KG):	4,7	
	M. CARTON WEIGHT (LBS):	10,34	
	M. CARTON SIZE (M):	0,8X0,6X0,32	
	M. CARTON SIZE (INCH):	31,5X23,62X12,6	



► STRONG YKK BUCKLES

**UNIVERSAL VEST LIME GREEN**

ITEM NUMBER	EAN CODE	HS CODE	FEATURES
244819503	PCS. 8718181014670	63072000	PACKAGE: 4 VESTS 50N ISO-CERTIFIED (BUOYANCY AID) LIGHTWEIGHT PE-FOAM STRONG & LIGHTWEIGHT NYLON FABRIC 1" ADJUSTABLE WEBBING STRAPS (3X) STRONG YKK BUCKLES ALWAYS A PERFECT FIT: MORE COMFORT AND SAFETY WATER DRAINAGE SYSTEM ADJUSTABLE SIZING DUE TO OPEN SIDES UNISEX FIT VENTILATING TRANSPARENT BAG
SIZE	MASTER CARTON INFO		
PCS.	QUANTITY PER M. CARTON:	10	
	M. CARTON WEIGHT (KG):	6,38	
	M. CARTON WEIGHT (LBS):	14,036	
	M. CARTON SIZE (M):	0,8X0,6X0,32	
	M. CARTON SIZE (INCH):	31,5X23,62X12,6	



**UNIVERSAL PACKAGE**

<i>ITEM NUMBER</i>	<i>EAN CODE</i>	<i>HS CODE</i>	<i>FEATURES</i>
24481771	PCS. 8718181210423	63072000	PACKAGE: 4 VESTS 50N ISO-CERTIFIED (BUOYANCY AID) LIGHTWEIGHT PE-FOAM STRONG & LIGHTWEIGHT NYLON FABRIC 1" ADJUSTABLE WEBBING STRAPS (3X) STRONG YKK BUCKLES ALWAYS A PERFECT FIT: MORE COMFORT AND SAFETY WATER DRAINAGE SYSTEM ADJUSTABLE SIZING DUE TO OPEN SIDES UNISEX FIT VENTILATING TRANSPARENT BAG
<i>SIZE</i>	<i>MASTER CARTON INFO</i>		
PCS.	QUANTITY PER M. CARTON: 1 M. CARTON WEIGHT (KG): 2,398 M. CARTON WEIGHT (LBS): 5,2756 M. CARTON SIZE (M): 0,58X0,48X0,29 M. CARTON SIZE (INCH): 22,83X18,9X11,42		



► STRONG YKK BUCKLES



► 50N ISO-CERTIFIED (BUOYANCY AID)

**DUAL VEST RED**

**ITEM NUMBER**

244817574

**SIZE**

S/M | L/XL | 2XL/3XL | 4XL/5XL

**EAN CODE**

S/M 8718181210829  
 L/XL 8718181210812  
 2XL/3XL 8718181210799  
 4XL/5XL 8718181210805

**HS CODE**

63072000

**MASTER CARTON INFO**

QUANTITY PER M. CARTON: 10  
 M. CARTON WEIGHT (KG): 5,4  
 M. CARTON WEIGHT (LBS): 11,88  
 M. CARTON SIZE (M): 0,8X0,6X0,38  
 M. CARTON SIZE (INCH): 31,5X23,62X14,96

**FEATURES**

50N ISO-CERTIFIED (BUOYANCY AID)  
 LIGHTWEIGHT PE-FOAM  
 STRONG & LIGHTWEIGHT NYLON FABRIC  
 1" ADJUSTABLE WEBBING STRAPS (4X)  
 STRONG YKK BUCKLES  
 ALWAYS A PERFECT FIT: MORE COMFORT AND SAFETY  
 SAFETY D-RING FOR ATTACHMENT EMERGENCY CORD  
 WATER DRAINAGE SYSTEM  
 ADJUSTABLE SIZING DUE TO NYLON SIDES  
 UNISEX FIT



► STRONG YKK BUCKLES



► 50N ISO-CERTIFIED (BUOYANCY AID)

**DUAL VEST BLUE**

ITEM NUMBER	EAN CODE	HS CODE	FEATURES
244817573	S/M 8718181210744 L/XL 8718181210737 2XL/3XL 8718181210713 4XL/5XL 8718181210720	63072000	50N ISO-CERTIFIED (BUOYANCY AID) LIGHTWEIGHT PE-FOAM STRONG & LIGHTWEIGHT NYLON FABRIC 1" ADJUSTABLE WEBBING STRAPS (4X) STRONG YKK BUCKLES ALWAYS A PERFECT FIT: MORE COMFORT AND SAFETY SAFETY D-RING FOR ATTACHMENT EMERGENCY CORD WATER DRAINAGE SYSTEM ADJUSTABLE SIZING DUE TO NYLON SIDES UNISEX FIT
<b>SIZE</b>		<b>MASTER CARTON INFO</b>	
S/M   L/XL   2XL/3XL   4XL/5XL		QUANTITY PER M. CARTON: 10 M. CARTON WEIGHT (KG): 5,7 M. CARTON WEIGHT (LBS): 12,54 M. CARTON SIZE (M): 0,8X0,6X0,38 M. CARTON SIZE (INCH): 31,5X23,62X14,96	





► STRONG YKK BUCKLES



► 50N ISO-CERTIFIED (BUOYANCY AID)

**DUAL VEST LIME GREEN**

**ITEM NUMBER**

244819502

**EAN CODE**

S/M 8718181014663  
 L/XL 8718181014656  
 2XL/3XL 8718181014632  
 4XL/5XL 8718181014649

**HS CODE**

63072000

**FEATURES**

50N ISO-CERTIFIED (BUOYANCY AID)  
 LIGHTWEIGHT PE-FOAM  
 STRONG & LIGHTWEIGHT NYLON FABRIC  
 1" ADJUSTABLE WEBBING STRAPS (4X)  
 STRONG YKK BUCKLES  
 ALWAYS A PERFECT FIT: MORE COMFORT AND SAFETY  
 SAFETY D-RING FOR ATTACHMENT EMERGENCY CORD  
 WATER DRAINAGE SYSTEM  
 ADJUSTABLE SIZING DUE TO NYLON SIDES  
 UNISEX FIT

**SIZE**

S/M | L/XL | 2XL/3XL | 4XL/5XL

**MASTER CARTON INFO**

QUANTITY PER M. CARTON: 10  
 M. CARTON WEIGHT (KG): 12,76  
 M. CARTON WEIGHT (LBS): 28,072  
 M. CARTON SIZE (M): 0,8X0,6X0,38  
 M. CARTON SIZE (INCH): 31,5X23,62X14,96



► STRONG YKK ZIPPER



► LIGHTWEIGHT PE-FOAM

**NYLON VEST WOMEN HOT PINK**

ITEM NUMBER	EAN CODE	HS CODE	FEATURES
244919230	XS 8718181002950 S 8718181002929 S+ 8718181002936	63072000	50N ISO-CERTIFIED (BUOYANCY AID) LIGHTWEIGHT PE-FOAM FRONT ZIPPER FOR FAST ENTRY
<b>SIZE</b>	M 8718181002905 M+ 8718181002912	<b>MASTER CARTON INFO</b>	STRONG & LIGHTWEIGHT NYLON FABRIC 1,5" ADJUSTABLE WEBBING STRAPS (2X)
XS   S   S+   M   M+   L   XL   2XL	L 8718181002899 XL 8718181002943 2XL 8718181002882	QUANTITY PER M. CARTON: 10 M. CARTON WEIGHT (KG): 5,1 M. CARTON WEIGHT (LBS): 11,22 M. CARTON SIZE (M): 0,8X0,6X0,35 M. CARTON SIZE (INCH): 31,5X23,62X13,78	STRONG YKK BUCKLES STRONG YKK ZIPPER ALWAYS A PERFECT FIT: MORE COMFORT AND SAFETY SAFETY D-RING FOR ATTACHMENT EMERGENCY CORD WATER DRAINAGE SYSTEM



► STRONG YKK ZIPPER



► LIGHTWEIGHT PE-FOAM

**NYLON VEST WOMEN INDIGO BLUE**

ITEM NUMBER	EAN CODE	HS CODE	FEATURES
244919231	XS 8718181003032 S 8718181003001 S+ 8718181003018	63072000	50N ISO-CERTIFIED (BUOYANCY AID) LIGHTWEIGHT PE-FOAM FRONT ZIPPER FOR FAST ENTRY
<b>SIZE</b>	M 8718181002981 M+ 8718181002998	<b>MASTER CARTON INFO</b>	STRONG & LIGHTWEIGHT NYLON FABRIC 1,5" ADJUSTABLE WEBBING STRAPS (2X)
XS   S   S+   M   M+   L   XL   2XL	L 8718181002974 XL 8718181003025 2XL 8718181002967	QUANTITY PER M. CARTON: 10 M. CARTON WEIGHT (KG): 5,1 M. CARTON WEIGHT (LBS): 11,22 M. CARTON SIZE (M): 0,8X0,6X0,32 M. CARTON SIZE (INCH): 31,5X23,62X13,78	STRONG YKK BUCKLES STRONG YKK ZIPPER ALWAYS A PERFECT FIT: MORE COMFORT AND SAFETY SAFETY D-RING FOR ATTACHMENT EMERGENCY CORD WATER DRAINAGE SYSTEM



► STRONG YKK BUCKLES



► 50N ISO-CERTIFIED (BUOYANCY AID)

**4 BUCKLE VEST RED**

ITEM NUMBER	EAN CODE	HS CODE	FEATURES
244817572	XS 8718181211260 S 8718181211246 M 8718181211239	63072000	50N ISO-CERTIFIED (BUOYANCY AID) SOFT PVC FOAM ON FRONT & SIDES, LIGHTWEIGHT PE-FOAM ON BACK
<b>SIZE</b>	L 8718181227032 XL 8718181211253 2XL 8718181211277 3XL 8718181211284	<b>MASTER CARTON INFO</b>	STRONG & LIGHTWEIGHT NYLON FABRIC 1,5" ADJUSTABLE WEBBING STRAPS (4X) STRONG YKK BUCKLES ALWAYS A PERFECT FIT: MORE COMFORT AND SAFETY SAFETY D-RING FOR ATTACHMENT EMERGENCY CORD WATER DRAINAGE SYSTEM UNISEX FIT
XS   S   M   L   XL   2XL   3XL		QUANTITY PER M. CARTON: 10 M. CARTON WEIGHT (KG): 9,1 M. CARTON WEIGHT (LBS): 20,02 M. CARTON SIZE (M): 0,8X0,6X0,52 M. CARTON SIZE (INCH): 31,5X23,62X20,47	



► STRONG YKK BUCKLES



► 50N ISO-CERTIFIED (BUOYANCY AID)

**4 BUCKLE VEST BLUE**

ITEM NUMBER	EAN CODE	HS CODE	FEATURES
244817571	XS 8718181211123 S 8718181211109 M 8718181211093	63072000	50N ISO-CERTIFIED (BUOYANCY AID) SOFT PVC FOAM ON FRONT & SIDES, LIGHTWEIGHT PE-FOAM ON BACK
<b>SIZE</b>	L 8718181211086 XL 8718181211116	<b>MASTER CARTON INFO</b>	STRONG & LIGHTWEIGHT NYLON FABRIC 1,5" ADJUSTABLE WEBBING STRAPS (4X)
XS   S   M   L   XL   2XL   3XL	2XL 8718181211130 3XL 8718181211147	QUANTITY PER M. CARTON: 10 M. CARTON WEIGHT (KG): 9,2 M. CARTON WEIGHT (LBS): 20,24 M. CARTON SIZE (M): 0,8X0,6X0,52 M. CARTON SIZE (INCH): 31,5X23,62X20,47	STRONG YKK BUCKLES ALWAYS A PERFECT FIT: MORE COMFORT AND SAFETY SAFETY D-RING FOR ATTACHMENT EMERGENCY CORD WATER DRAINAGE SYSTEM UNISEX FIT



► STRONG YKK BUCKLES



► 50N ISO-CERTIFIED (BUOYANCY AID)

**4 BUCKLE VEST BLACK**

ITEM NUMBER	EAN CODE	HS CODE	FEATURES
244817570	XS 8718181210997 S 8718181210973 M 8718181210966	63072000	50N ISO-CERTIFIED (BUOYANCY AID) SOFT PVC FOAM ON FRONT & SIDES, LIGHTWEIGHT PE-FOAM ON BACK
<b>SIZE</b>	L 8718181210959 XL 8718181210980 2XL 8718181211000 3XL 8718181211017 4XL 8718181258852	<b>MASTER CARTON INFO</b>	STRONG & LIGHTWEIGHT NYLON FABRIC 1,5" ADJUSTABLE WEBBING STRAPS (4X) STRONG YKK BUCKLES ALWAYS A PERFECT FIT: MORE COMFORT AND SAFETY SAFETY D-RING FOR ATTACHMENT EMERGENCY CORD WATER DRAINAGE SYSTEM UNISEX FIT
XS   S   M   L   XL   2XL   3XL   4XL		QUANTITY PER M. CARTON: 10 M. CARTON WEIGHT (KG): 9 M. CARTON WEIGHT (LBS): 19,8 M. CARTON SIZE (M): 0,8X0,6X0,52 M. CARTON SIZE (INCH): 31,5X23,62X20,47	



**MIX  
AND  
MATCH**



► STRONG YKK ZIPPER



► 50N ISO-CERTIFIED (BUOYANCY AID)

**NEOPRENE VEST WOMEN COOL GREY**

ITEM NUMBER	EAN CODE	HS CODE	FEATURES
244919220	XS 8718181002707 S 8718181002677 S+ 8718181002684	63072000	50N ISO-CERTIFIED (BUOYANCY AID) SOFT PVC FOAM FRONT ZIPPER FOR FAST ENTRY
<b>SIZE</b>	M 8718181002653 M+ 8718181002660 L 8718181002639 XL 8718181002691 2XL 8718181002615 3XL 8718181002622	<b>MASTER CARTON INFO</b>	SOFT & FLEXIBLE NEOPRENE FABRIC 1,5" ADJUSTABLE WEBBING STRAPS (2X) STRONG YKK BUCKLES STRONG YKK ZIPPER
XS   S   S+   M   M+   L   XL   2XL   3XL		QUANTITY PER M. CARTON: 10 M. CARTON WEIGHT (KG): 11,2 M. CARTON WEIGHT (LBS): 24,64 M. CARTON SIZE (M): 0,8X0,6X0,35 M. CARTON SIZE (INCH): 31,5X23,62X13,78	ALWAYS A PERFECT FIT: MORE COMFORT AND SAFETY SAFETY D-RING FOR ATTACHMENT EMERGENCY CORD WATER DRAINAGE SYSTEM





► STRONG YKK ZIPPER



► 50N ISO-CERTIFIED (BUOYANCY AID)

**NEOPRENE VEST WOMEN BORDEAUX RED**

ITEM NUMBER	EAN CODE	HS CODE	FEATURES
244919221	XS 8718181002783 S 8718181002752 S+ 8718181002769	63072000	50N ISO-CERTIFIED (BUOYANCY AID) SOFT PVC FOAM FRONT ZIPPER FOR FAST ENTRY
<b>SIZE</b>	M 8718181002738 M+ 8718181002745 L 8718181002721 XL 8718181002776 2XL 8718181002714	<b>MASTER CARTON INFO</b>	SOFT & FLEXIBLE NEOPRENE FABRIC 1,5" ADJUSTABLE WEBBING STRAPS (2X) STRONG YKK BUCKLES STRONG YKK ZIPPER
XS   S   S+   M   M+   L   XL   2XL		QUANTITY PER M. CARTON: 10 M. CARTON WEIGHT (KG): 11,2 M. CARTON WEIGHT (LBS): 24,64 M. CARTON SIZE (M): 0,8X0,6X0,35 M. CARTON SIZE (INCH): 31,5X23,62X13,78	ALWAYS A PERFECT FIT: MORE COMFORT AND SAFETY SAFETY D-RING FOR ATTACHMENT EMERGENCY CORD WATER DRAINAGE SYSTEM



► STRONG YKK ZIPPER



► SOFT & FLEXIBLE NEOPRENE FABRIC

**UNIFY VEST WOMEN BLACK**

ITEM NUMBER	EAN CODE	HS CODE	FEATURES
244919201	XS 8718181002400 S 8718181002370 S+ 8718181002387	63072000	50N ISO-CERTIFIED (BUOYANCY AID) COMFORT OF A NON-CERTIFIED VEST SOFT PVC FOAM
<b>SIZE</b>	M 8718181002356 M+ 8718181002363 L 8718181002349 XL 8718181002394 2XL 8718181002332	<b>MASTER CARTON INFO</b>	FRONT ZIPPER FOR FAST ENTRY SOFT & FLEXIBLE NEOPRENE FABRIC 1,5" ADJUSTABLE WEBBING STRAP (1X) INTEGRATED WEBBING FOR A CLEAN LOOK STRONG YKK BUCKLE   STRONG YKK ZIPPER ALWAYS A PERFECT FIT: MORE COMFORT AND SAFETY SPLIT FOAM PANELS FOR MAXIMUM FREEDOM OF MOVEMENT WATER DRAINAGE SYSTEM POCKET INSIDE WITH WATERPROOF BAG CONNECTOR CORD
XS   S   S+   M   M+   L   XL   2XL		QUANTITY PER M. CARTON: 10 M. CARTON WEIGHT (KG): 12,2 M. CARTON WEIGHT (LBS): 26,84 M. CARTON SIZE (M): 0,8X0,6X0,45 M. CARTON SIZE (INCH): 31,5X23,62X17,72	



► STRONG YKK ZIPPER



► SOFT & FLEXIBLE NEOPRENE FABRIC

**UNIFY VEST WOMEN HOT PINK**

ITEM NUMBER	EAN CODE	HS CODE	FEATURES
244919200	XS 8718181002325 S 8718181002295 S+ 8718181002301	63072000	50N ISO-CERTIFIED (BUOYANCY AID) COMFORT OF A NON-CERTIFIED VEST SOFT PVC FOAM
<b>SIZE</b>	M 8718181002271 M+ 8718181002288	<b>MASTER CARTON INFO</b>	FRONT ZIPPER FOR FAST ENTRY SOFT & FLEXIBLE NEOPRENE FABRIC
XS   S   S+   M   M+   L   XL   2XL	L 8718181002264 XL 8718181002318 2XL 8718181002257	QUANTITY PER M. CARTON: 10 M. CARTON WEIGHT (KG): 12,2 M. CARTON WEIGHT (LBS): 26,84 M. CARTON SIZE (M): 0,8X0,6X0,45 M. CARTON SIZE (INCH): 31,5X23,62X17,72	1,5" ADJUSTABLE WEBBING STRAP (1X) INTEGRATED WEBBING FOR A CLEAN LOOK STRONG YKK BUCKLE   STRONG YKK ZIPPER ALWAYS A PERFECT FIT: MORE COMFORT AND SAFETY SPLIT FOAM PANELS FOR MAXIMUM FREEDOM OF MOVEMENT WATER DRAINAGE SYSTEM POCKET INSIDE WITH WATERPROOF BAG CONNECTOR CORD



► STRONG YKK ZIPPER



► STRONG YKK BUCKLE

**UNIFY VEST WOMEN INDIGO BLUE**

ITEM NUMBER	EAN CODE	HS CODE	FEATURES
244919202	XS 8718181015097 S 8718181015066 S+ 8718181015073	63072000	50N ISO-CERTIFIED (BUOYANCY AID) COMFORT OF A NON-CERTIFIED VEST SOFT PVC FOAM
<b>SIZE</b>	M 8718181015042 M+ 8718181015059	<b>MASTER CARTON INFO</b>	FRONT ZIPPER FOR FAST ENTRY SOFT & FLEXIBLE NEOPRENE FABRIC
XS   S   S+   M   M+   L   XL   2XL	L 8718181015035 XL 8718181015080 2XL 8718181015028	QUANTITY PER M. CARTON: 10 M. CARTON WEIGHT (KG): 12,2 M. CARTON WEIGHT (LBS): 26,84 M. CARTON SIZE (M): 0,8X0,6X0,45 M. CARTON SIZE (INCH): 31,5X23,62X17,72	1,5" ADJUSTABLE WEBBING STRAP (1X) INTEGRATED WEBBING FOR A CLEAN LOOK STRONG YKK BUCKLE   STRONG YKK ZIPPER ALWAYS A PERFECT FIT: MORE COMFORT AND SAFETY SPLIT FOAM PANELS FOR MAXIMUM FREEDOM OF MOVEMENT WATER DRAINAGE SYSTEM POCKET INSIDE WITH WATERPROOF BAG CONNECTOR CORD



► STRONG YKK ZIPPER



► STRONG YKK BUCKLE

**UNIFY VEST WOMEN DARK TEAL**

ITEM NUMBER	EAN CODE	HS CODE	FEATURES
244919203	XS 8718181015172 S 8718181015141 S+ 8718181015158	63072000	50N ISO-CERTIFIED (BUOYANCY AID) COMFORT OF A NON-CERTIFIED VEST SOFT PVC FOAM
<b>SIZE</b>	M 8718181015127 M+ 8718181015134	<b>MASTER CARTON INFO</b>	FRONT ZIPPER FOR FAST ENTRY SOFT & FLEXIBLE NEOPRENE FABRIC
XS   S   S+   M   M+   L   XL   2XL	L 8718181015110 XL 8718181015165 2XL 8718181015103	QUANTITY PER M. CARTON: 10 M. CARTON WEIGHT (KG): 12,2 M. CARTON WEIGHT (LBS): 26,84 M. CARTON SIZE (M): 0,8X0,6X0,45 M. CARTON SIZE (INCH): 31,5X23,62X17,72	1,5" ADJUSTABLE WEBBING STRAP (1X) INTEGRATED WEBBING FOR A CLEAN LOOK STRONG YKK BUCKLE   STRONG YKK ZIPPER ALWAYS A PERFECT FIT: MORE COMFORT AND SAFETY SPLIT FOAM PANELS FOR MAXIMUM FREEDOM OF MOVEMENT WATER DRAINAGE SYSTEM POCKET INSIDE WITH WATERPROOF BAG CONNECTOR CORD



**MIX  
AND  
MATCH**





► STRONG YKK BUCKLES



► FRONT ZIPPER FOR FAST ENTRY



► SOFT PVC FOAM

### NEOPRENE VEST MEN RED

ITEM NUMBER	EAN CODE	HS CODE	FEATURES
244918105	S 8718181245487 M 8718181245470 L 8718181245463	63072000	50N ISO-CERTIFIED (BUOYANCY AID) SOFT PVC FOAM FRONT ZIPPER FOR FAST ENTRY SOFT & FLEXIBLE NEOPRENE FABRIC
<b>SIZE</b>	XL 8718181245494 XL+ 8718181253383 2XL+ 8718181253390 3XL+ 8718181253406	<b>MASTER CARTON INFO</b>	1,5" ADJUSTABLE WEBBING STRAPS (2X) STRONG YKK BUCKLES STRONG YKK ZIPPER ALWAYS A PERFECT FIT: MORE COMFORT AND SAFETY SAFETY D-RING FOR ATTACHMENT EMERGENCY CORD WATER DRAINAGE SYSTEM
S   M   L   XL   XL+   2XL+   3XL+		QUANTITY PER M. CARTON: 10 M. CARTON WEIGHT (KG): 17,5 M. CARTON WEIGHT (LBS): 38,5 M. CARTON SIZE (M): 0,8X0,6X0,45 M. CARTON SIZE (INCH): 31,5X23,62X17,72	



► STRONG YKK BUCKLES



► FRONT ZIPPER FOR FAST ENTRY



► SOFT PVC FOAM

**NEOPRENE VEST MEN BLUE**

ITEM NUMBER	EAN CODE	HS CODE	FEATURES
244918106	S 8718181245548 M 8718181245531 L 8718181245524	63072000	50N ISO-CERTIFIED (BUOYANCY AID) SOFT PVC FOAM FRONT ZIPPER FOR FAST ENTRY SOFT & FLEXIBLE NEOPRENE FABRIC 1,5" ADJUSTABLE WEBBING STRAPS (2X) STRONG YKK BUCKLES STRONG YKK ZIPPER ALWAYS A PERFECT FIT: MORE COMFORT AND SAFETY SAFETY D-RING FOR ATTACHMENT EMERGENCY CORD WATER DRAINAGE SYSTEM
<b>SIZE</b>	XL 8718181245562 XL+ 8718181253550 2XL+ 8718181253567 3XL+ 8718181253574	<b>MASTER CARTON INFO</b>	
S   M   L   XL   XL+   2XL+   3XL+		QUANTITY PER M. CARTON: 10 M. CARTON WEIGHT (KG): 14,1 M. CARTON WEIGHT (LBS): 31,02 M. CARTON SIZE (M): 0,8X0,6X0,45 M. CARTON SIZE (INCH): 31,5X23,62X17,72	





► STRONG YKK BUCKLES



► FRONT ZIPPER FOR FAST ENTRY



► SOFT PVC FOAM

**NEOPRENE VEST MEN LIME GREEN**

ITEM NUMBER	EAN CODE	HS CODE	FEATURES
244918103	S 8718181245340 M 8718181245333 L 8718181245326	63072000	50N ISO-CERTIFIED (BUOYANCY AID) SOFT PVC FOAM FRONT ZIPPER FOR FAST ENTRY SOFT & FLEXIBLE NEOPRENE FABRIC 1,5" ADJUSTABLE WEBBING STRAPS (2X)
<b>SIZE</b>	XL 8718181245357 XL+ 8718181259705 2XL+ 8718181259712 3XL+ 8718181259729	<b>MASTER CARTON INFO</b>	STRONG YKK BUCKLES STRONG YKK ZIPPER ALWAYS A PERFECT FIT: MORE COMFORT AND SAFETY SAFETY D-RING FOR ATTACHMENT EMERGENCY CORD WATER DRAINAGE SYSTEM
S   M   L   XL   XL+   2XL+   3XL+		QUANTITY PER M. CARTON: 10 M. CARTON WEIGHT (KG): 14,3 M. CARTON WEIGHT (LBS): 31,46 M. CARTON SIZE (M): 0,8X0,6X0,45 M. CARTON SIZE (INCH): 31,5X23,62X17,72	



► STRONG YKK BUCKLES



► FRONT ZIPPER FOR FAST ENTRY



► SOFT PVC FOAM

**NEOPRENE VEST MEN BLACK**

ITEM NUMBER	EAN CODE	HS CODE	FEATURES
244918104	XS 8718181245432 S 8718181245418 M 8718181245401 L 8718181245395 XL 8718181245425	63072000	50N ISO-CERTIFIED (BUOYANCY AID) SOFT PVC FOAM FRONT ZIPPER FOR FAST ENTRY SOFT & FLEXIBLE NEOPRENE FABRIC 1,5" ADJUSTABLE WEBBING STRAPS (2X)
<b>SIZE</b>	XL+ 8718181259736 2XL+ 8718181259743 3XL+ 8718181259750 4XL+ 8718181259767 5XL+ 8718181259774	<b>MASTER CARTON INFO</b>	STRONG YKK BUCKLES STRONG YKK ZIPPER ALWAYS A PERFECT FIT: MORE COMFORT AND SAFETY SAFETY D-RING FOR ATTACHMENT EMERGENCY CORD WATER DRAINAGE SYSTEM
XS   S   M   L   XL   XL+   2XL+   3XL+   4XL+   5XL+		QUANTITY PER M. CARTON: 10 M. CARTON WEIGHT (KG): 14,3 M. CARTON WEIGHT (LBS): 31,46 M. CARTON SIZE (M): 0,8X0,6X0,45 M. CARTON SIZE (INCH): 31,5X23,62X17,72	



► STRONG YKK ZIPPER



► STRONG YKK BUCKLES



► SOFT PVC FOAM



► SAFETY D-RING

**SEGMENTED VEST MEN ARMY GREEN**

ITEM NUMBER	EAN CODE	HS CODE	FEATURES
244919121	S 8718181001991 M 8718181001984 L 8718181001977	63072000	50N ISO-CERTIFIED (BUOYANCY AID) SOFT PVC FOAM FRONT ZIPPER FOR FAST ENTRY SOFT & FLEXIBLE NEOPRENE FABRIC 1,5" ADJUSTABLE WEBBING STRAPS (2X) INTEGRATED WEBBING FOR A CLEAN LOOK
<b>SIZE</b>	XL 8718181002004 XL+ 8718181002011 2XL+ 8718181001953 3XL+ 8718181001960	<b>MASTER CARTON INFO</b>	STRONG YKK BUCKLES STRONG YKK ZIPPER ALWAYS A PERFECT FIT: MORE COMFORT AND SAFETY SPLIT FOAM PANELS FOR MAXIMUM FREEDOM OF MOVEMENT SAFETY D-RING FOR ATTACHMENT EMERGENCY CORD WATER DRAINAGE SYSTEM
S   M   L   XL   XL+   2XL+   3XL+		QUANTITY PER M. CARTON: 10 M. CARTON WEIGHT (KG): 13,9 M. CARTON WEIGHT (LBS): 30,58 M. CARTON SIZE (M): 0,8X0,6X0,45 M. CARTON SIZE (INCH): 31,5 X 23,62 X 17,72	



► STRONG YKK ZIPPER



► STRONG YKK BUCKLES



► SOFT PVC FOAM



► SAFETY D-RING

**SEGMENTED VEST MEN DARK TEAL**

ITEM NUMBER	EAN CODE	HS CODE	FEATURES
244919123	S 8718181002066 M 8718181002059 L 8718181002042	63072000	50N ISO-CERTIFIED (BUOYANCY AID) SOFT PVC FOAM FRONT ZIPPER FOR FAST ENTRY SOFT & FLEXIBLE NEOPRENE FABRIC
<b>SIZE</b>	XL 8718181002073 XL+ 8718181002080 2XL+ 8718181002028 3XL+ 8718181002035	<b>MASTER CARTON INFO</b>	1,5" ADJUSTABLE WEBBING STRAPS (2X) INTEGRATED WEBBING FOR A CLEAN LOOK STRONG YKK BUCKLES STRONG YKK ZIPPER ALWAYS A PERFECT FIT: MORE COMFORT AND SAFETY
S   M   L   XL   XL+   2XL+   3XL+		QUANTITY PER M. CARTON: 10 M. CARTON WEIGHT (KG): 13,9 M. CARTON WEIGHT (LBS): 30,58 M. CARTON SIZE (M): 0,8X0,6X0,45 M. CARTON SIZE (INCH): 31,5X23,62X17,72	SPLIT FOAM PANELS FOR MAXIMUM FREEDOM OF MOVEMENT SAFETY D-RING FOR ATTACHMENT EMERGENCY CORD WATER DRAINAGE SYSTEM



► STRONG YKK ZIPPER



► STRONG YKK BUCKLE



► SOFT PVC FOAM

### UNIFY VEST MEN BLACK

ITEM NUMBER	EAN CODE	HS CODE	FEATURES
244919100	XS 8718181001281 S 8718181001250 M 8718181001205 L 8718181001199 XL 8718181001267 XL+ 8718181001274 2XL+ 8718181001533 3XL+ 8718181001540	63072000	50N ISO-CERTIFIED (BUOYANCY AID) COMFORT OF A NON-CERTIFIED VEST SOFT PVC FOAM FRONT ZIPPER FOR FAST ENTRY SOFT & FLEXIBLE NEOPRENE FABRIC 1,5" ADJUSTABLE WEBBING STRAP (1X) INTEGRATED WEBBING FOR A CLEAN LOOK STRONG YKK BUCKLE   STRONG YKK ZIPPER ALWAYS A PERFECT FIT: MORE COMFORT AND SAFETY SPLIT FOAM PANELS FOR MAXIMUM FREEDOM OF MOVEMENT WATER DRAINAGE SYSTEM INSIDE POCKET WITH WATERPROOF BAG CONNECTOR CORD
<b>SIZE</b>		<b>MASTER CARTON INFO</b>	
XS   S   M   L   XL   XL+   2XL+   3XL+		QUANTITY PER M. CARTON: 10 M. CARTON WEIGHT (KG): 12,9 M. CARTON WEIGHT (LBS): 28,38 M. CARTON SIZE (M): 0,8X0,6X0,55 M. CARTON SIZE (INCH): 31,5X23,62X21,65	



► STRONG YKK ZIPPER



► STRONG YKK BUCKLE



► SOFT PVC FOAM

**UNIFY VEST MEN ARMY GREEN**

ITEM NUMBER	EAN CODE	HS CODE	FEATURES
244919106	XS 8718181015011 S 8718181014984 M 8718181014977 L 8718181014960 XL 8718181014991 XL+ 8718181015004 2XL+ 8718181014946 3XL+ 8718181014953	63072000	50N ISO-CERTIFIED (BUOYANCY AID) COMFORT OF A NON-CERTIFIED VEST SOFT PVC FOAM FRONT ZIPPER FOR FAST ENTRY SOFT & FLEXIBLE NEOPRENE FABRIC 1,5" ADJUSTABLE WEBBING STRAP (1X) INTEGRATED WEBBING FOR A CLEAN LOOK STRONG YKK BUCKLE   STRONG YKK ZIPPER ALWAYS A PERFECT FIT: MORE COMFORT AND SAFETY SPLIT FOAM PANELS FOR MAXIMUM FREEDOM OF MOVEMENT WATER DRAINAGE SYSTEM INSIDE POCKET WITH WATERPROOF BAG CONNECTOR CORD
<b>SIZE</b>		<b>MASTER CARTON INFO</b>	
XS   S   M   L   XL   XL+   2XL+   3XL+		QUANTITY PER M. CARTON: 10 M. CARTON WEIGHT (KG): 12,9 M. CARTON WEIGHT (LBS): 28,38 M. CARTON SIZE (M): 0,8X0,6X0,55 M. CARTON SIZE (INCH): 31,5X23,62X21,65	



► STRONG YKK ZIPPER



► STRONG YKK BUCKLE



► SOFT PVC FOAM

**UNIFY VEST MEN DARK TEAL**

ITEM NUMBER	EAN CODE	HS CODE	FEATURES
244919101	XS 8718181001625 S 8718181001595 M 8718181001588 L 8718181001571 XL 8718181001601 XL+ 8718181001618 2XL+ 8718181001557 3XL+ 8718181001564	63072000	50N ISO-CERTIFIED (BUOYANCY AID) COMFORT OF A NON-CERTIFIED VEST SOFT PVC FOAM FRONT ZIPPER FOR FAST ENTRY SOFT & FLEXIBLE NEOPRENE FABRIC 1,5" ADJUSTABLE WEBBING STRAP (1X) INTEGRATED WEBBING FOR A CLEAN LOOK STRONG YKK BUCKLE   STRONG YKK ZIPPER ALWAYS A PERFECT FIT: MORE COMFORT AND SAFETY SPLIT FOAM PANELS FOR MAXIMUM FREEDOM OF MOVEMENT WATER DRAINAGE SYSTEM INSIDE POCKET WITH WATERPROOF BAG CONNECTOR CORD
<b>SIZE</b>		<b>MASTER CARTON INFO</b>	
XS   S   M   L   XL   XL+   2XL+   3XL+		QUANTITY PER M. CARTON: 10 M. CARTON WEIGHT (KG): 12,9 M. CARTON WEIGHT (LBS): 28,38 M. CARTON SIZE (M): 0,8X0,6X0,55 M. CARTON SIZE (INCH): 31,5X23,62X21,65	



► STRONG YKK ZIPPER



► STRONG YKK BUCKLE



► SOFT PVC FOAM

**UNIFY VEST MEN MARBLE GREEN**

ITEM NUMBER	EAN CODE	HS CODE	FEATURES
244919105	XS 8718181014939 S 8718181014908 M 8718181014892 L 8718181014885 XL 8718181014915 XL+ 8718181014922 2XL+ 8718181014861 3XL+ 8718181014878	63072000	50N ISO-CERTIFIED (BUOYANCY AID) COMFORT OF A NON-CERTIFIED VEST SOFT PVC FOAM FRONT ZIPPER FOR FAST ENTRY SOFT & FLEXIBLE NEOPRENE FABRIC 1,5" ADJUSTABLE WEBBING STRAP (1X) INTEGRATED WEBBING FOR A CLEAN LOOK STRONG YKK BUCKLE   STRONG YKK ZIPPER ALWAYS A PERFECT FIT: MORE COMFORT AND SAFETY SPLIT FOAM PANELS FOR MAXIMUM FREEDOM OF MOVEMENT WATER DRAINAGE SYSTEM INSIDE POCKET WITH WATERPROOF BAG CONNECTOR CORD
<b>SIZE</b> XS   S   M   L   XL   XL+   2XL+   3XL+		<b>MASTER CARTON INFO</b> QUANTITY PER M. CARTON: 10 M. CARTON WEIGHT (KG): 12,9 M. CARTON WEIGHT (LBS): 28,38 M. CARTON SIZE (M): 0,8X0,6X0,55 M. CARTON SIZE (INCH): 31,5X23,62X21,65	





► STRONG YKK ZIPPER



► STRONG YKK BUCKLE



► SOFT PVC FOAM

### UNIFY VEST MEN RED

ITEM NUMBER	EAN CODE	HS CODE	FEATURES
244919104	XS 8718181014854 S 8718181014823 M 8718181014816 L 8718181014809 XL 8718181014830 XL+ 8718181014847 2XL+ 8718181014786 3XL+ 8718181014793	63072000	50N ISO-CERTIFIED (BUOYANCY AID) COMFORT OF A NON-CERTIFIED VEST SOFT PVC FOAM FRONT ZIPPER FOR FAST ENTRY SOFT & FLEXIBLE NEOPRENE FABRIC 1,5" ADJUSTABLE WEBBING STRAP (1X) INTEGRATED WEBBING FOR A CLEAN LOOK STRONG YKK BUCKLE   STRONG YKK ZIPPER ALWAYS A PERFECT FIT: MORE COMFORT AND SAFETY SPLIT FOAM PANELS FOR MAXIMUM FREEDOM OF MOVEMENT WATER DRAINAGE SYSTEM INSIDE POCKET WITH WATERPROOF BAG CONNECTOR CORD
<b>SIZE</b>		<b>MASTER CARTON INFO</b>	
XS   S   M   L   XL   XL+   2XL+   3XL+		QUANTITY PER M. CARTON: 10 M. CARTON WEIGHT (KG): 12,9 M. CARTON WEIGHT (LBS): 28,38 M. CARTON SIZE (M): 0,8X0,6X0,55 M. CARTON SIZE (INCH): 31,5X23,62X21,65	



► STRONG YKK ZIPPER



► STRONG YKK BUCKLE



► SOFT PVC FOAM

**UNIFY VEST MEN LIME GREEN**

ITEM NUMBER	EAN CODE	HS CODE	FEATURES
244919103	XS 8718181014779 S 8718181014748 M 8718181014731 L 8718181014724 XL 8718181014755	63072000	50N ISO-CERTIFIED (BUOYANCY AID) COMFORT OF A NON-CERTIFIED VEST SOFT PVC FOAM FRONT ZIPPER FOR FAST ENTRY SOFT & FLEXIBLE NEOPRENE FABRIC
<b>SIZE</b>	XL+ 8718181014762 2XL+ 8718181014700 3XL+ 8718181014717	<b>MASTER CARTON INFO</b>	1,5" ADJUSTABLE WEBBING STRAP (1X) INTEGRATED WEBBING FOR A CLEAN LOOK STRONG YKK BUCKLE   STRONG YKK ZIPPER ALWAYS A PERFECT FIT: MORE COMFORT AND SAFETY SPLIT FOAM PANELS FOR MAXIMUM FREEDOM OF MOVEMENT WATER DRAINAGE SYSTEM INSIDE POCKET WITH WATERPROOF BAG CONNECTOR CORD
XS   S   M   L   XL   XL+   2XL+   3XL+		QUANTITY PER M. CARTON: 10 M. CARTON WEIGHT (KG): 12,9 M. CARTON WEIGHT (LBS): 28,38 M. CARTON SIZE (M): 0,8X0,6X0,55 M. CARTON SIZE (INCH): 31,5X23,62X21,65	



**MIX  
AND  
MATCH**





**INFLATABLE ARMBANDS**

<i>ITEM NUMBER</i>	<i>EAN CODE</i>	<i>HS CODE</i>	<i>FEATURES</i>
600018001	PCS. 8718181261296	95062900	2 ARMBANDS PER SET INFLATABLE STRONG PVC FABRIC SOFT INNER LINING FOR OPTIMAL COMFORT
<i>SIZE</i>	<i>MASTER CARTON INFO</i>		
PCS.	<i>QUANTITY PER M. CARTON:</i> 100 <i>M. CARTON WEIGHT (KG):</i> 103,1 <i>M. CARTON WEIGHT (LBS):</i> 227,29 <i>M. CARTON SIZE (M):</i> 0,51 X 0,38 X 0,36 <i>M. CARTON SIZE (INCH):</i> 20,08 X 14,96 X 14,17		



► BRIGHT COLOR & REFLECTING PANELS



► WHISTLE IN CASE OF EMERGENCY

**COMFORT BOATING VEST YOUTH ORANGE**

ITEM NUMBER	EAN CODE	HS CODE	FEATURES
244817375	4XS 8718181210331 3XS/2XS 8718181210324 XS/S 8718181210355 M/L 8718181210348	63072000	100N ISO-CERTIFIED (LIFE JACKET) LIGHTWEIGHT PE-FOAM FRONT ZIPPER FOR FAST ENTRY STRONG & LIGHTWEIGHT NYLON FABRIC 1,5" ADJUSTABLE WEBBING STRAP (1X) 1" ADJUSTABLE WEBBING STRAP (1X) STRONG YKK BUCKLES STRONG YKK ZIPPER CROTCH STRAPS FOR OPTIMAL SAFETY BRIGHT COLOR & REFLECTING PANELS FOR OPTIMAL VISIBILITY WHISTLE IN CASE OF EMERGENCY UNISEX FIT
<b>SIZE</b>		<b>MASTER CARTON INFO</b>	
4XS   3XS/2XS   XS/S   M/L		QUANTITY PER M. CARTON: 10 M. CARTON WEIGHT (KG): 4,3 M. CARTON WEIGHT (LBS): 9,46 M. CARTON SIZE (M): 0,6X0,4X0,67 M. CARTON SIZE (INCH): 23,62X15,75X26,38	



► BRIGHT COLOR & REFLECTING PANELS



► WHISTLE IN CASE OF EMERGENCY

**COMFORT BOATING VEST YOUTH YELLOW**

ITEM NUMBER	EAN CODE	HS CODE	FEATURES
244817374	4XS 8718181210140 3XS/2XS 8718181210133 XS/S 8718181210164 M/L 8718181210157	63072000	100N ISO-CERTIFIED (LIFE JACKET) LIGHTWEIGHT PE-FOAM FRONT ZIPPER FOR FAST ENTRY STRONG & LIGHTWEIGHT NYLON FABRIC 1,5" ADJUSTABLE WEBBING STRAP (1X) 1" ADJUSTABLE WEBBING STRAP (1X) STRONG YKK BUCKLES STRONG YKK ZIPPER CROTCH STRAPS FOR OPTIMAL SAFETY BRIGHT COLOR & REFLECTING PANELS FOR OPTIMAL VISIBILITY WHISTLE IN CASE OF EMERGENCY UNISEX FIT
<b>SIZE</b>	4XS   3XS/2XS   XS/S   M/L	<b>MASTER CARTON INFO</b>	
		QUANTITY PER M. CARTON: 10 M. CARTON WEIGHT (KG): 4,3 M. CARTON WEIGHT (LBS): 9,46 M. CARTON SIZE (M): 0,6X0,4X0,67 M. CARTON SIZE (INCH): 23,62X15,75X26,38	



► WHISTLE IN CASE OF EMERGENCY



► BRIGHT COLOR & REFLECTING PANELS

**COMFORT BOATING VEST ORANGE**

ITEM NUMBER	EAN CODE	HS CODE	FEATURES
244817579	JR 8718181210218	63072000	100N ISO-CERTIFIED (LIFE JACKET)
	S 8718181210249		LIGHTWEIGHT PE-FOAM
	M 8718181210232		FRONT ZIPPER FOR FAST ENTRY
<b>SIZE</b>	L 8718181210225	<b>MASTER CARTON INFO</b>	STRONG & LIGHTWEIGHT NYLON FABRIC
JR   S   M   L   XL	XL 8718181210256	QUANTITY PER M. CARTON: 10	1,5" ADJUSTABLE WEBBING STRAP (1X)
		M. CARTON WEIGHT (KG): 5,4	1" ADJUSTABLE WEBBING STRAP (1X)
		M. CARTON WEIGHT (LBS): 11,88	STRONG YKK BUCKLES
		M. CARTON SIZE (M): 0,8X0,6X0,56	STRONG YKK ZIPPER
		M. CARTON SIZE (INCH): 31,5X23,62X22,05	CROTCH STRAPS FOR OPTIMAL SAFETY
			BRIGHT COLOR & REFLECTING PANELS FOR OPTIMAL VISIBILITY
			WHISTLE IN CASE OF EMERGENCY
			UNISEX FIT



► STRONG & LIGHTWEIGHT NYLON FABRIC



► 100N ISO-CERTIFIED (LIFE JACKET)



► WHISTLE IN CASE OF EMERGENCY

**EASY BOATING PACKAGE**

ITEM NUMBER	EAN CODE	HS CODE	FEATURES
244817770	PCS. 8718181210317	63072000	PACKAGE: 5 VESTS 100N ISO-CERTIFIED (LIFE JACKET) LIGHTWEIGHT PE-FOAM STRONG & LIGHTWEIGHT NYLON FABRIC BRIGHT COLOR & REFLECTING PANELS FOR OPTIMAL VISIBILITY WHISTLE IN CASE OF EMERGENCY VENTILATING TRANSPARENT BAG UNISEX FIT
SIZE	MASTER CARTON INFO		
PCS.	QUANTITY PER M. CARTON:	1	
	M. CARTON WEIGHT (KG):	16,3	
	M. CARTON WEIGHT (LBS):	35,86	
	M. CARTON SIZE (M):	0,63 X 0,35 X 0,38	
	M. CARTON SIZE (INCH):	24,8 X 3,78 X 14,96	





**PET VEST RED**

ITEM NUMBER	EAN CODE	HS CODE	FEATURES
240017602	XS 8718181209977 S 8718181209960 M 8718181209953	63072000	STRONG & LIGHTWEIGHT NYLON FABRIC SOFT PVC FOAM NEOPRENE INNER LAYER FOR COMFORT HANDLE ON BACK OF THE VEST 1" ADJUSTABLE WEBBING STRAPS STRONG YKK BUCKLES SAFETY D-RING FOR ATTACHMENT EMERGENCY CORD WATER DRAINAGE SYSTEM
<b>SIZE</b>		<b>MASTER CARTON INFO</b>	
XS   S   M		QUANTITY PER M. CARTON: 20 M. CARTON WEIGHT (KG): 3 M. CARTON WEIGHT (LBS): 6,6 M. CARTON SIZE (M): 0,6X0,4X0,26 M. CARTON SIZE (INCH): 23,62X15,75X10,24	



**DOG LEASH**

ITEM NUMBER	EAN CODE	HS CODE	FEATURES
210017034	PCS. 8718181208864	95062900	LENGTH 8 FT/2.43 M. 6 INCH/15.24 CM RUBBER GRIP HANDLE
<b>SIZE</b>	<b>MASTER CARTON INFO</b>		
PCS.	QUANTITY PER M. CARTON: 12		
	M. CARTON WEIGHT (KG): 3,12		
	M. CARTON WEIGHT (LBS): 6,864		
	M. CARTON SIZE (M): 0,34X0,19X0,25		
	M. CARTON SIZE (INCH): 13,39X7,48X9,84		



**WETSUITS**

# WETSUIT TECHNOLOGY

## FULL STRETCH

POLYESTER TOP LAYER FOR EXCELLENT STRETCH, A SMOOTH FEELING AND A SOFT TOUCH



SCR FOAM FOR A COMFORTABLE FEELING

POLYESTER BOTTOM LAYER FOR EXCELLENT STRETCH, A SMOOTH FEELING AND A SOFT TOUCH

## SUPREME STRETCH

POLYESTER TOP LAYER FOR EXCELLENT STRETCH, A SMOOTH FEELING AND A SOFT TOUCH



CR FOAM FOR A COMFORTABLE FEELING AND SOFT TOUCH

POLYESTER BOTTOM LAYER FOR EXCELLENT STRETCH, A SMOOTH FEELING, COMFORTABLE AND WARM

## FLATLOCK STITCHING TECHNIQUE

FLATLOCK STITCHING IS THE MOST COMMON FORM OF SEAM STITCHING AND BY FAR THE MOST DURABLE. FLATLOCK WORKS BY OVERLAPPING THE NEOPRENE PANELS AND SEWING THEM TOGETHER. THE PROCESS OF FLATLOCK STITCHING ADDS TINY HOLES THROUGH THE NEOPRENE WHICH IN TURN ALLOWS COLD WATER TO ENTER THE SUIT. FOR THAT REASON, FLATLOCK STITCHED WETSUITS ARE NOT DESIGNED FOR REALLY COLD WATER.

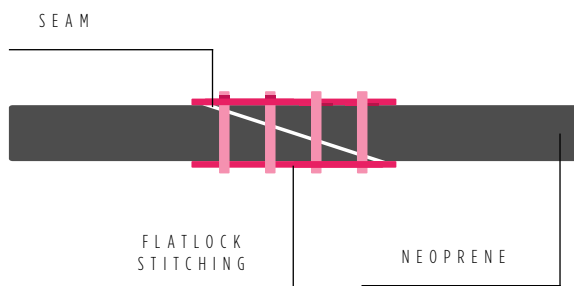

## BLINDSTITCH TECHNIQUE

THE EDGES OF THE PANELS ARE PLACED END ON END AND GLUED TOGETHER. THEY ARE THEN STITCHED ON THE INSIDE, BUT THE STITCHING DOES NOT GO ALL THE WAY THROUGH TO THE OUTSIDE OF THE PANELS. RESULT: WATERTIGHT, FLEXIBLE SEAMS. THIS IS THE IDEAL SEAM FOR COLD WATER TEMPERATURES, AND IS THE ONE FOUND ON HIGHER QUALITY, MORE EXPENSIVE WETSUITS.

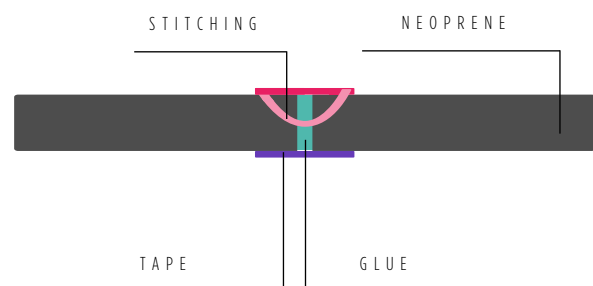

# SIZING WETSUITS

## YOUTH WETSUITS

SIZE	CHEST (CM)	CHEST (INCH)	WAIST (CM)	WAIST (INCH)	HIP (CM)	HIP (INCH)	LENGTH (CM)	LENGTH (INCH)
2XS	54-58	21,3-22,8	50-53	19,7-20,9	51-55	20,1-21,7	≤104	≤40,9
XS	58-60	22,8-23,6	53-55	20,9-21,7	55-61	21,7-24	≤116	≤45,7
S	60-63	23,6-24,8	55-59	21,7-23,2	61-67	24-26,4	≤128	≤50,4
M	62-66	24,4-26	57-61	22,4-24	64-70	25,2-27,6	≤134	≤52,8
L	63-70	24,8-27,6	59-63	23,2-24,8	67-73	26,4-28,7	≤146	≤57,5
XL	70-76	27,6-29,9	63-69	24,8-27,2	73-79	28,7-31,1	≤152	≤59,8
2XL	76-83	29,9-32,7	69-74	27,2-29,1	79-85	31,1-33,5	≤164	≤64,6
3XL	83-89	32,7-35	74-78	29,1-30,7	85-91	33,5-35,8	≤176	≤69,3

## WOMEN WETSUITS

SIZE	CHEST (CM)	CHEST (INCH)	WAIST (CM)	WAIST (INCH)	HIP (CM)	HIP (INCH)	LENGTH (CM)	LENGTH (INCH)
XS	84-88	33,1-34,6	68-72	26,8-28,3	90-94	35,4-37	165-171	65-67,3
S	88-92	34,6-36,2	72-76	28,3-29,9	94-98	37-38,6	167-173	65,7-68,1
M	93-99	36,6-39	77-83	30,3-32,7	99-105	39-41,3	169-175	66,5-68,9
L	99-105	39-41,3	83-89	32,7-35	105-111	41,3-43,7	171-177	67,3-69,7
XL	105-111	41,3-43,7	89-95	35-37,4	111-117	43,7-46,1	173-179	68,1-70,5
2XL	111-117	43,7-46,1	95-101	37,4-39,8	117-123	46,1-48,4	175-181	68,9-71,3

## MEN WETSUITS

SIZE	CHEST (CM)	CHEST (INCH)	WAIST (CM)	WAIST (INCH)	HIP (CM)	HIP (INCH)	LENGTH (CM)	LENGTH (INCH)
XS	90-94	35,4-37	80-84	31,5-33,1	90-94	35,4-37	173-179	68,1-70,5
S	94-98	37-38,6	84-88	33,1-34,6	94-98	37-38,6	175-181	68,9-71,3
M	98-102	38,6-40,2	88-92	34,6-36,2	98-102	38,6-40,2	177-183	69,7-72
MT	98-102	38,6-40,2	88-92	34,6-36,2	98-102	38,6-40,2	179-185	70,5-72,8
L	102-106	40,2-41,7	92-96	36,2-37,8	102-106	40,2-41,7	179-185	70,5-72,8
LT	102-106	40,2-41,7	92-96	36,2-37,8	102-106	40,2-41,7	181-187	71,3-73,6
XL	106-110	41,7-43,3	96-100	37,8-39,4	106-110	41,7-43,3	181-187	71,3-73,6
2XL	111-117	43,7-46,1	101-107	39,8-42,1	111-117	43,7-46,1	183-189	72-74,4
3XL	117-123	46,1-48,4	107-113	42,1-44,5	117-123	46,1-48,4	185-191	72,8-75,2
4XL	123-129	48,4-50,8	113-119	44,5-46,9	123-129	48,4-50,8	187-193	73,6-76

WE ARE CONSTANTLY WORKING ON THE SIZING OF OUR PRODUCTS. CHECK OUT [JOBESPORTS.COM](https://www.jobesports.com) FOR THE MOST UP TO DATE, IMPROVED SIZING!

ALL MEASUREMENTS ARE FOR REFERENCE ONLY.



# CHOOSE WISELY

FREEZING WATER TEMPERATURE

COLD WATER TEMPERATURE



**YUKON FULLSUIT 5/3MM**



**YUKON FULLSUIT 4/3MM**



**PORTLAND FULLSUIT 3/2MM CHESTZIP**



**PORTLAND FULLSUIT 3/2MM**



**PERTH FULLSUIT 3/2MM CHESTZIP**



**PERTH FULLSUIT 3/2MM**  
GRAPHITE GREY | RED | BLUE



**ASPEN FULLSUIT 5/3MM CHESTZIP**



**VICTORIA FULLSUIT 3/2MM CHESTZIP**



**VICTORIA FULLSUIT 3/2MM REVER.**



**SOFIA FULLSUIT 3/2MM**  
INDIGO BLUE | HOT PINK | DARK TEAL



**MALMO FULLSUIT 5/3MM CHESTZIP**



**BOSTON FULLSUIT 3/2MM**  
ARMY GREEN | RED | BLUE | HOT PINK

FREEZING WATER TEMPERATURE

COLD WATER TEMPERATURE

# TEMPERATURE MATTERS

PLEASANT WATER TEMPERATURE

WARM WATER TEMPERATURE



**ATLANTA FULLSUIT 2MM**



**PERTH SHORTY 3/2MM**  
LIME GREEN | ARMY GREEN | RED |  
BLUE | GRAPHITE GREY



**ATLANTA SHORTY 2MM**



**PERTH SHORTY 1.5MM**



**SAVANNAH FULLSUIT 2MM**



**SOFA SHORTY LS 3/2MM**  
BLACK



**SOFA SHORTY 3/2MM**  
HOT PINK | INDIGO BLUE



**SAVANNAH SHORTY 2MM**



**SOFA SHORTY SHORT 2MM**



**SOFA SHORTY 1.5MM**

Despite of what most people think, wetsuits aren't meant to keep you dry. A wetsuit is meant to protect your body and keep you warm during your water sports practices. Choose your wetsuit wisely and take differences in stretch, neoprene-thickness and technical innovations into account. Water temperature and weather circumstances serve as a good starting point. When facing colder waters and heavier weather circumstances go with a full suit or a Steamer. These ranges are engineered with thicker neoprene (starting from 3/2 mm up till 5/3 mm) and the suits are equipped with lots of technical innovations to keep the heat and loose the water – by glued seams for instance. Choose a shorty and/or thinner neoprene when you go and play in pleasant water temperatures: this range starts from 1.5 mm neoprene-thickness and can be recognized by innovations like breathable stitched constructions.



**BOSTON SHORTY 2MM**  
ARMY GREEN | RED | BLUE | HOT PINK  
| LIME GREEN

PLEASANT WATER TEMPERATURE

WARM WATER TEMPERATURE



► 2 MM NEOPRENE



► FULL STRETCH NEOPRENE



► BACK ZIPPER

**BOSTON SHORTY 2MM HOT PINK**

ITEM NUMBER	EAN CODE	HS CODE	FEATURES
303619311	2XS 8718181005500 XS 8718181005562 S 8718181005548	61130010	2 MM NEOPRENE THICKNESS FULL STRETCH NEOPRENE SOFT & FLEXIBLE STITCHED SEAMS STRENGTHENING TAPE INSIDE BACK ZIPPER FOR FAST ENTRY UNISEX FIT
<b>SIZE</b>	M 8718181005531 L 8718181005524 XL 8718181005555 2XL 8718181005494 3XL 8718181005517	<b>MASTER CARTON INFO</b>	
2XS   XS   S   M   L   XL   2XL   3XL		QUANTITY PER M. CARTON: 10 M. CARTON WEIGHT (KG): 5 M. CARTON WEIGHT (LBS): 11 M. CARTON SIZE (M): 1,07 X 0,53 X 0,11 M. CARTON SIZE (INCH): 42 X 21 X 4,5	





► 2 MM NEOPRENE



► SOFT & FLEXIBLE STITCHED SEAMS



► BACK ZIPPER

**BOSTON SHORTY 2MM RED**

ITEM NUMBER	EAN CODE	HS CODE	FEATURES
303617352	2XS 8718181221825 XS 8718181221801 S 8718181221788	61130010	2 MM NEOPRENE THICKNESS FULL STRETCH NEOPRENE SOFT & FLEXIBLE STITCHED SEAMS STRENGTHENING TAPE INSIDE BACK ZIPPER FOR FAST ENTRY UNISEX FIT
<b>SIZE</b>	M 8718181221771 L 8718181221764 XL 8718181221795 2XL 8718181221818 3XL 8718181221832	<b>MASTER CARTON INFO</b>	
2XS   XS   S   M   L   XL   2XL   3XL		QUANTITY PER M. CARTON: 10 M. CARTON WEIGHT (KG): 4,7 M. CARTON WEIGHT (LBS): 10,34 M. CARTON SIZE (M): 1,07 X 0,53 X 0,11 M. CARTON SIZE (INCH): 42 X 21 X 4,5	



► 2 MM NEOPRENE



► SOFT & FLEXIBLE STITCHED SEAMS



► BACK ZIPPER

**BOSTON SHORTY 2MM BLUE**

ITEM NUMBER	EAN CODE	HS CODE	FEATURES
303617351	2XS 8718181221665 XS 8718181221641 S 8718181221627	61130010	2 MM NEOPRENE THICKNESS FULL STRETCH NEOPRENE SOFT & FLEXIBLE STITCHED SEAMS STRENGTHENING TAPE INSIDE BACK ZIPPER FOR FAST ENTRY UNISEX FIT
<b>SIZE</b>	M 8718181221610 L 8718181221603 XL 8718181221634 2XL 8718181221658 3XL 8718181221672	<b>MASTER CARTON INFO</b>	
2XS   XS   S   M   L   XL   2XL   3XL		QUANTITY PER M. CARTON: 10 M. CARTON WEIGHT (KG): 7,7 M. CARTON WEIGHT (LBS): 16,94 M. CARTON SIZE (M): 1,07 X 0,53 X 0,11 M. CARTON SIZE (INCH): 42 X 21 X 4,5	



► 2 MM NEOPRENE



► BACK ZIPPER



► SOFT & FLEXIBLE STITCHED SEAMS

**BOSTON SHORTY 2MM ARMY GREEN**

ITEM NUMBER	EAN CODE	HS CODE	FEATURES
303619310	2XS 8718181005425 XS 8718181005487 S 8718181005463 M 8718181005456 L 8718181005449 XL 8718181005470 2XL 8718181005418 3XL 8718181005432	61130010	2 MM NEOPRENE THICKNESS FULL STRETCH NEOPRENE SOFT & FLEXIBLE STITCHED SEAMS STRENGTHENING TAPE INSIDE BACK ZIPPER FOR FAST ENTRY UNISEX FIT
<b>SIZE</b> 2XS   XS   S   M   L   XL   2XL   3XL		<b>MASTER CARTON INFO</b> QUANTITY PER M. CARTON: 10 M. CARTON WEIGHT (KG): 5 M. CARTON WEIGHT (LBS): 11 M. CARTON SIZE (M): 1,07 X 0,53 X 0,11 M. CARTON SIZE (INCH): 42 X 21 X 4,5	



► 2 MM NEOPRENE



► FEMININE FIT



► FULL STRETCH NEOPRENE

**SOFIA SHORTY SHORT 2MM**

ITEM NUMBER	EAN CODE	HS CODE	FEATURES
303619222	XS 8718181005364 S 8718181005357 M 8718181005340 L 8718181005333	61130010	2 MM NEOPRENE THICKNESS FULL STRETCH NEOPRENE SOFT & FLEXIBLE STITCHED SEAMS STRENGTHENING TAPE INSIDE SHORT FRONT ZIPPER FEMININE FIT
<b>SIZE</b>		<b>MASTER CARTON INFO</b>	
XS   S   M   L		QUANTITY PER M. CARTON: 10 M. CARTON WEIGHT (KG): 4,7 M. CARTON WEIGHT (LBS): 10,34 M. CARTON SIZE (M): 1,19 X 0,54 X 0,11 M. CARTON SIZE (INCH): 47 X 21,1 X 4,5	



► 1.5 MM NEOPRENE



► SOFT & FLEXIBLE STITCHED SEAMS

**SOFIA SHORTY 1.5MM**

ITEM NUMBER	EAN CODE	HS CODE	FEATURES
303619223	S 8718181005395 M 8718181005388 L 8718181005371 XL 8718181005401	61130010	1.5 MM NEOPRENE THICKNESS FULL STRETCH NEOPRENE SOFT & FLEXIBLE STITCHED SEAMS STRENGTHENING TAPE INSIDE BACK ZIPPER FOR FAST ENTRY FEMININE FIT
<b>SIZE</b>		<b>MASTER CARTON INFO</b>	
S   M   L   XL		QUANTITY PER M. CARTON: 10 M. CARTON WEIGHT (KG): 4,7 M. CARTON WEIGHT (LBS): 10,34 M. CARTON SIZE (M): 1,19 X 0,54 X 0,11 M. CARTON SIZE (INCH): 47 X 21,1 X 4,5	



► 2 MM NEOPRENE



► BACK ZIPPER

**SAVANNAH SHORTY 2MM**

ITEM NUMBER	EAN CODE	HS CODE	FEATURES
303617254	S 8718181220064 M 8718181220057 L 8718181220040	61130010	2 MM NEOPRENE THICKNESS REGULAR STRETCH NEOPRENE SOFT & FLEXIBLE STITCHED SEAMS STRENGTHENING TAPE INSIDE BACK ZIPPER FOR FAST ENTRY FEMININE FIT
<b>SIZE</b>	XL 8718181220071 2XL 8718181220088	<b>MASTER CARTON INFO</b>	
S   M   L   XL   2XL		QUANTITY PER M. CARTON: 10 M. CARTON WEIGHT (KG): 7,7 M. CARTON WEIGHT (LBS): 16,94 M. CARTON SIZE (M): 1,19 X 0,54 X 0,11 M. CARTON SIZE (INCH): 47 X 21,1 X 4,5	



► 3/2 MM NEOPRENE

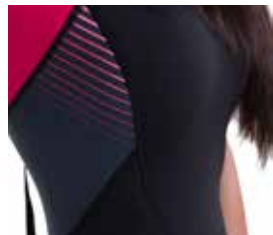

► FEMININE FIT



► BACK ZIPPER

**SOFIA SHORTY 3/2MM HOT PINK**

ITEM NUMBER	EAN CODE	HS CODE	FEATURES
303619220	XS 8718181005289 S 8718181005265 M 8718181005258 L 8718181005241 XL 8718181005272	61130010	3MM NEOPRENE ON CHEST & BACK, 2MM ON OTHER PANELS FULL STRETCH NEOPRENE SOFT & FLEXIBLE STITCHED SEAMS STRENGTHENING TAPE INSIDE BACK ZIPPER FOR FAST ENTRY FEMININE FIT
<b>SIZE</b>	XS   S   M   L   XL   2XL	<b>MASTER CARTON INFO</b>	
		QUANTITY PER M. CARTON: 10 M. CARTON WEIGHT (KG): 6,6 M. CARTON WEIGHT (LBS): 14,52 M. CARTON SIZE (M): 1,19 X 0,54 X 0,11 M. CARTON SIZE (INCH): 47 X 21,1 X 4,5	



► 3/2 MM NEOPRENE



► BACK ZIPPER



► FEMININE FIT

**SOFIA SHORTY 3/2MM INDIGO BLUE**

ITEM NUMBER	EAN CODE	HS CODE	FEATURES
303619221	S 8718181005319 M 8718181005302 L 8718181005296 XL 8718181005326	61130010	3MM NEOPRENE ON CHEST & BACK, 2MM ON OTHER PANELS FULL STRETCH NEOPRENE SOFT & FLEXIBLE STITCHED SEAMS STRENGTHENING TAPE INSIDE BACK ZIPPER FOR FAST ENTRY FEMININE FIT
<b>SIZE</b>		<b>MASTER CARTON INFO</b>	
S   M   L   XL		QUANTITY PER M. CARTON: 10 M. CARTON WEIGHT (KG): 6,5 M. CARTON WEIGHT (LBS): 14,3 M. CARTON SIZE (M): 1,19 X 0,54 X 0,11 M. CARTON SIZE (INCH): 47 X 21,1 X 4,5	





► BACK ZIPPER



► WATER BLOCKING WRIST TAPE

**SOFIA SHORTY LONGSLEEVE 3/2MM BLACK**

ITEM NUMBER	EAN CODE	HS CODE	FEATURES
303619210	XS 8718181005180 S 8718181005173 M 8718181005166 L 8718181005159	61130010	3MM NEOPRENE ON CHEST & BACK, 2MM ON OTHER PANELS FULL STRETCH NEOPRENE SOFT & FLEXIBLE STITCHED SEAMS STRENGTHENING TAPE INSIDE BACK ZIPPER FOR FAST ENTRY WATER BLOCKING WRIST TAPE FEMININE FIT
<b>SIZE</b>		<b>MASTER CARTON INFO</b>	
XS   S   M   L		QUANTITY PER M. CARTON: 10 M. CARTON WEIGHT (KG): 7,1 M. CARTON WEIGHT (LBS): 15,62 M. CARTON SIZE (M): 1,19 X 0,54 X 0,11 M. CARTON SIZE (INCH): 47 X 21,1 X 4,5	



**NEOPRENE SHORT**

ITEM NUMBER	EAN CODE	HS CODE	FEATURES
300017150	S 8718181215329 M 8718181215312 L 8718181215305	61130010	2 MM NEOPRENE THICKNESS FULL STRETCH NEOPRENE SOFT & FLEXIBLE STITCHED SEAMS
<b>SIZE</b>	XL 8718181215343 2XL 8718181215367 3XL 8718181215374	<b>MASTER CARTON INFO</b>	
S   M   L   XL   2XL   3XL		QUANTITY PER M. CARTON: 10 M. CARTON WEIGHT (KG): 4,5 M. CARTON WEIGHT (LBS): 9,9 M. CARTON SIZE (M): 0,56X0,48X0,14 M. CARTON SIZE (INCH): 22X19X5,5	



► 1.5 MM NEOPRENE



► BACK ZIPPER

**PERTH SHORTY 1.5MM**

ITEM NUMBER	EAN CODE	HS CODE	FEATURES
303617156	S 8718181218016 M 8718181218009 L 8718181217996	61130010	1.5 MM NEOPRENE THICKNESS FULL STRETCH NEOPRENE SOFT & FLEXIBLE STITCHED SEAMS
<b>SIZE</b>	XL 8718181218023 2XL 8718181218030 3XL 8718181218047	<b>MASTER CARTON INFO</b>	BACK ZIPPER FOR FAST ENTRY STRENGTHENING TAPE INSIDE
S   M   L   XL   2XL   3XL		QUANTITY PER M. CARTON: 10 M. CARTON WEIGHT (KG): 5,6 M. CARTON WEIGHT (LBS): 12,32 M. CARTON SIZE (M): 1,19 X 0,54 X 0,11 M. CARTON SIZE (INCH): 47 X 21,1 X 4,5	



► 2 MM NEOPRENE



► SOFT & FLEXIBLE STITCHED SEAMS

**ATLANTA SHORTY 2MM**

ITEM NUMBER	EAN CODE	HS CODE	FEATURES
303617155	S 8718181217897 M 8718181217880 L 8718181217873	61130010	2 MM NEOPRENE THICKNESS REGULAR STRETCH NEOPRENE SOFT & FLEXIBLE STITCHED SEAMS STRENGTHENING TAPE INSIDE BACK ZIPPER FOR FAST ENTRY
<b>SIZE</b>	XL 8718181217903 2XL 8718181217910 3XL 8718181217927	<b>MASTER CARTON INFO</b>	
S   M   L   XL   2XL   3XL		QUANTITY PER M. CARTON: 10 M. CARTON WEIGHT (KG): 7 M. CARTON WEIGHT (LBS): 15,4 M. CARTON SIZE (M): 1,19 X 0,54 X 0,11 M. CARTON SIZE (INCH): 47 X 21,1 X 4,5	



► 3/2 MM NEOPRENE



► SOFT & FLEXIBLE STITCHED SEAMS



► BACK ZIPPER

**PERTH SHORTY 3|2MM RED**

ITEM NUMBER	EAN CODE	HS CODE	FEATURES
303617154	S 8718181217538 M 8718181217521 L 8718181217514	61130010	3 2 MM NEOPRENE THICKNESS - 3MM ON CHEST & BACK - 2MM ON OTHER PANELS
<b>SIZE</b>	XL 8718181217545 2XL 8718181217552 3XL 8718181217569	<b>MASTER CARTON INFO</b>	FULL STRETCH NEOPRENE SOFT & FLEXIBLE STITCHED SEAMS STRENGTHENING TAPE INSIDE BACK ZIPPER FOR FAST ENTRY
S   M   L   XL   2XL   3XL		QUANTITY PER M. CARTON: 10 M. CARTON WEIGHT (KG): 7,2 M. CARTON WEIGHT (LBS): 15,84 M. CARTON SIZE (M): 1,19 X 0,54 X 0,11 M. CARTON SIZE (INCH): 47 X 21,1 X 4,5	



▶ 3/2 MM NEOPRENE



▶ SOFT & FLEXIBLE STITCHED SEAMS

**PERTH SHORTY 3|2MM BLUE**

ITEM NUMBER	EAN CODE	HS CODE	FEATURES
303617152	S 8718181217293 M 8718181217286 L 8718181217279	61130010	3 2 MM NEOPRENE THICKNESS - 3MM ON CHEST & BACK - 2MM ON OTHER PANELS
<b>SIZE</b>	XL 8718181217309 2XL 8718181217316 3XL 8718181217323	<b>MASTER CARTON INFO</b>	FULL STRETCH NEOPRENE SOFT & FLEXIBLE STITCHED SEAMS STRENGTHENING TAPE INSIDE BACK ZIPPER FOR FAST ENTRY
S   M   L   XL   2XL   3XL		QUANTITY PER M. CARTON: 10 M. CARTON WEIGHT (KG): 7,7 M. CARTON WEIGHT (LBS): 16,94 M. CARTON SIZE (M): 1,19 X 0,54 X 0,11 M. CARTON SIZE (INCH): 47 X 21,1 X 4,5	



▶ 3/2 MM NEOPRENE



▶ BACK ZIPPER

**PERTH SHORTY 3|2MM LIME GREEN**

ITEM NUMBER	EAN CODE	HS CODE	FEATURES
303619120	S 8718181005074 M 8718181005067 L 8718181005050 XL 8718181005081 2XL 8718181005036 3XL 8718181005043	61130010	3MM NEOPRENE ON CHEST & BACK, 2MM ON OTHER PANELS FULL STRETCH NEOPRENE SOFT & FLEXIBLE STITCHED SEAMS STRENGTHENING TAPE INSIDE BACK ZIPPER FOR FAST ENTRY
<b>SIZE</b> S   M   L   XL   2XL   3XL		<b>MASTER CARTON INFO</b> QUANTITY PER M. CARTON: 10 M. CARTON WEIGHT (KG): 4,7 M. CARTON WEIGHT (LBS): 10,34 M. CARTON SIZE (M): 1,19 X 0,54 X 0,11 M. CARTON SIZE (INCH): 47 X 21,1 X 4,5	



▶ 3/2 MM NEOPRENE



▶ BACK ZIPPER

**PERTH SHORTY 3|2MM ARMY GREEN**

ITEM NUMBER	EAN CODE	HS CODE	FEATURES
303619121	S 8718181005135 M 8718181005128 L 8718181005111	61130010	3MM NEOPRENE ON CHEST & BACK, 2MM ON OTHER PANELS FULL STRETCH NEOPRENE SOFT & FLEXIBLE STITCHED SEAMS STRENGTHENING TAPE INSIDE BACK ZIPPER FOR FAST ENTRY
<b>SIZE</b>	XL 8718181005142 2XL 8718181005098 3XL 8718181005104	<b>MASTER CARTON INFO</b>	
S   M   L   XL   2XL   3XL		QUANTITY PER M. CARTON: 10 M. CARTON WEIGHT (KG): 4,7 M. CARTON WEIGHT (LBS): 10,34 M. CARTON SIZE (M): 1,19 X 0,54 X 0,11 M. CARTON SIZE (INCH): 47 X 21,1 X 4,5	





▶ 3/2 MM NEOPRENE



▶ SOFT & FLEXIBLE STITCHED SEAMS

**PERTH SHORTY 3|2MM GRAPHITE GREY**

ITEM NUMBER	EAN CODE	HS CODE	FEATURES
303617153	XS 8718181219495 S 8718181217415 M 8718181217408	61130010	3 2 MM NEOPRENE THICKNESS - 3MM ON CHEST & BACK - 2MM ON OTHER PANELS
<b>SIZE</b>	L 8718181217392 XL 8718181217422	<b>MASTER CARTON INFO</b>	FULL STRETCH NEOPRENE SOFT & FLEXIBLE STITCHED SEAMS
XS   S   M   L   XL   2XL   3XL   4XL	2XL 8718181217439 3XL 8718181217446 4XL 8718181219372	QUANTITY PER M. CARTON: 10 M. CARTON WEIGHT (KG): 7,7 M. CARTON WEIGHT (LBS): 16,94 M. CARTON SIZE (M): 1,19 X 0,54 X 0,11 M. CARTON SIZE (INCH): 47 X 21,1 X 4,5	STRENGTHENING TAPE INSIDE BACK ZIPPER FOR FAST ENTRY



► FULL STRETCH NEOPRENE



► SOFT & FLEXIBLE STITCHED SEAMS



► BACK ZIPPER

**BOSTON FULLSUIT 3/2MM HOT PINK**

ITEM NUMBER	EAN CODE	HS CODE	FEATURES
303519311	2XS 8718181004961 XS 8718181005029 S 8718181005005	61130010	3MM NEOPRENE ON CHEST & BACK, 2MM ON OTHER PANELS FULL STRETCH NEOPRENE SOFT & FLEXIBLE STITCHED SEAMS STRENGTHENING TAPE INSIDE BACK ZIPPER FOR FAST ENTRY PROTECTIVE STRONG KNEE PADS UNISEX FIT
<b>SIZE</b>	M 8718181004992 L 8718181004985 XL 8718181005012 2XL 8718181004954 3XL 8718181004978	<b>MASTER CARTON INFO</b>	
2XS   XS   S   M   L   XL   2XL   3XL		QUANTITY PER M. CARTON: 10 M. CARTON WEIGHT (KG): 6,9 M. CARTON WEIGHT (LBS): 15,18 M. CARTON SIZE (M): 0,99X0,51X0,18 M. CARTON SIZE (INCH): 39X20X7	



► 3/2 MM NEOPRENE



► FULL STRETCH NEOPRENE



► BACK ZIPPER

**BOSTON FULLSUIT 3/2MM RED**

ITEM NUMBER	EAN CODE	HS CODE	FEATURES
303517352	2XS 8718181221023 XS 8718181221009 S 8718181220989	61130010	3/2MM NEOPRENE THICKNESS - 3MM ON CHEST & BACK - 2MM ON OTHER PANELS
<b>SIZE</b>	M 8718181220972 L 8718181220965	<b>MASTER CARTON INFO</b>	FULL STRETCH NEOPRENE SOFT & FLEXIBLE STITCHED SEAMS
2XS   XS   S   M   L   XL   2XL   3XL	XL 8718181220996 2XL 8718181221016 3XL 8718181221030	QUANTITY PER M. CARTON: 10 M. CARTON WEIGHT (KG): 12,50 M. CARTON WEIGHT (LBS): 27,56 M. CARTON SIZE (M): 1,1 X 0,55 X 0,2 M. CARTON SIZE (INCH): 43,31 X 21,65 X 7,87	STRENGTHENING TAPE INSIDE BACK ZIPPER FOR FAST ENTRY PROTECTIVE STRONG KNEEPADS UNISEX FIT



► 3/2 MM NEOPRENE



► BACK ZIPPER FOR FAST ENTRY



► SOFT & FLEXIBLE STITCHED SEAMS

**BOSTON FULLSUIT 3/2MM BLUE**

ITEM NUMBER	EAN CODE	HS CODE	FEATURES
303517351	2XS 8718181220866 XS 8718181220842 S 8718181220828	61130010	3/2MM NEOPRENE THICKNESS: - 3MM ON CHEST & BACK - 2MM ON OTHER PANELS
<b>SIZE</b>	M 8718181220811 L 8718181220804	<b>MASTER CARTON INFO</b>	FULL STRETCH NEOPRENE SOFT & FLEXIBLE STITCHED SEAMS
2XS   XS   S   M   L   XL   2XL   3XL	XL 8718181220835 2XL 8718181220859 3XL 8718181220873	QUANTITY PER M. CARTON: 10 M. CARTON WEIGHT (KG): 12,1 M. CARTON WEIGHT (LBS): 26,62 M. CARTON SIZE (M): 0,99X0,51X0,18 M. CARTON SIZE (INCH): 39X20X7	STRENGTHENING TAPE INSIDE BACK ZIPPER FOR FAST ENTRY PROTECTIVE STRONG KNEE PADS UNISEX FIT



▶ 3/2 MM NEOPRENE



▶ SOFT & FLEXIBLE STITCHED SEAMS



▶ BACK ZIPPER

**BOSTON FULLSUIT 3/2MM ARMY GREEN**

ITEM NUMBER	EAN CODE	HS CODE	FEATURES
303519310	2XS 8718181004886 XS 8718181004947 S 8718181004923	61130010	3MM NEOPRENE ON CHEST & BACK, 2MM ON OTHER PANELS FULL STRETCH NEOPRENE SOFT & FLEXIBLE STITCHED SEAMS STRENGTHENING TAPE INSIDE BACK ZIPPER FOR FAST ENTRY PROTECTIVE STRONG KNEE PADS UNISEX FIT
<b>SIZE</b>	M 8718181004916 L 8718181004909 XL 8718181004930 2XL 8718181004879 3XL 8718181004893	<b>MASTER CARTON INFO</b>	
2XS   XS   S   M   L   XL   2XL   3XL		QUANTITY PER M. CARTON: 10 M. CARTON WEIGHT (KG): 6,9 M. CARTON WEIGHT (LBS): 15,18 M. CARTON SIZE (M): 0,99X0,51X0,18 M. CARTON SIZE (INCH): 39X20X7	



► CHEST ZIPPER



► THERMO INNER LINING



► KEY POCKET WITH ELASTIC CORD

**MALMÖ FULLSUIT 5|3MM**

ITEM NUMBER	EAN CODE	HS CODE	FEATURES
303519300	L 8718181004855 XL 8718181004862 2XL 8718181004831 3XL 8718181004848	61130010	5MM NEOPRENE ON CHEST & BACK, 3MM ON OTHER PANELS SUPREME STRETCH NEOPRENE GLUED & BLIND STITCHED SEAMS: NO WATER ENTRY THROUGH SEAMS   KEY POCKET WITH ELASTIC CORD STRENGTHENING TAPE INSIDE CHEST ZIPPER FOR MAX FLEX & MINIMAL WATER ENTRY WARM THERMO INNER LINING (CHEST & BACK) PROTECTIVE STRONG KNEE PADS COMFY MINIMAL SEAM TECHNOLOGY WATER BLOCKING WRIST & ANKLE TAPE WATER DRAINAGE SYSTEM UNISEX FIT
<b>SIZE</b>		<b>MASTER CARTON INFO</b>	
L   XL   2XL   3XL		QUANTITY PER M. CARTON: 10 M. CARTON WEIGHT (KG): 14,2 M. CARTON WEIGHT (LBS): 31,24 M. CARTON SIZE (M): 0,99X0,51X0,18 M. CARTON SIZE (INCH): 39 X 20 X 7	





► 2 MM NEOPRENE



► SOFT & FLEXIBLE STITCHED SEAMS

**SAVANNAH FULLSUIT 2MM**

ITEM NUMBER	EAN CODE	HS CODE	FEATURES
303517253	S 8718181219464 M 8718181219457 L 8718181219440	61130010	2 MM NEOPRENE THICKNESS REGULAR STRETCH NEOPRENE SOFT & FLEXIBLE STITCHED SEAMS STRENGTHENING TAPE INSIDE BACK ZIPPER FOR FAST ENTRY PROTECTIVE STRONG KNEE PADS
<b>SIZE</b>	XL 8718181219471 2XL 8718181219488	<b>MASTER CARTON INFO</b>	
S   M   L   XL   2XL		QUANTITY PER M. CARTON: 10 M. CARTON WEIGHT (KG): 12,1 M. CARTON WEIGHT (LBS): 26,62 M. CARTON SIZE (M): 1,02 X 0,56 X 0,18 M. CARTON SIZE (INCH): 40 X 22 X 7	





► 1.5 MM NEOPRENE



► REVERSIBLE



► SOFT & FLEXIBLE STITCHED SEAMS

**VERONA REVERSIBLE LEGGING 1.5MM BLACK**

ITEM NUMBER	EAN CODE	HS CODE	FEATURES
300019201	XS 8718181003995 S 8718181003971 M 8718181003964 L 8718181003957 XL 8718181003988	61130010	REVERSIBLE: 1 PRODUCT WITH 2 DESIGNS 1.5 MM NEOPRENE THICKNESS FULL STRETCH NEOPRENE SOFT & FLEXIBLE STITCHED SEAMS
<b>SIZE</b>		<b>MASTER CARTON INFO</b>	
XS   S   M   L   XL		QUANTITY PER M. CARTON: 10 M. CARTON WEIGHT (KG): 4,7 M. CARTON WEIGHT (LBS): 10,34 M. CARTON SIZE (M): 1,02X0,53X0,11 M. CARTON SIZE (INCH): 40X21X4,5	



► 1.5 MM NEOPRENE



► SHORT FRONT ZIPPER



► FULL STRETCH NEOPRENE

**VERONA TOP 1.5MM BLACK**

ITEM NUMBER	EAN CODE	HS CODE	FEATURES
300019200	XS 8718181003940 S 8718181003926 M 8718181003919	61130010	1.5 MM NEOPRENE THICKNESS FULL STRETCH NEOPRENE SOFT & FLEXIBLE STITCHED SEAMS
<b>SIZE</b>	L 8718181003902 XL 8718181003933	<b>MASTER CARTON INFO</b>	SHORT FRONT ZIPPER FEMININE FIT
XS   S   M   L   XL		QUANTITY PER M. CARTON: 10 M. CARTON WEIGHT (KG): 4,8 M. CARTON WEIGHT (LBS): 10,56 M. CARTON SIZE (M): 1,02 X 0,53 X 0,11 M. CARTON SIZE (INCH): 40 X 21 X 4,5	



► 1.5 MM NEOPRENE



► SOFT & FLEXIBLE SEAMS



► REVERSIBLE

**VERONA LEGGING 1.5MM REVERSIBLE INDIGO BLUE**

ITEM NUMBER	EAN CODE	HS CODE	FEATURES
300019203	XS 8718181004121 S 8718181004107 M 8718181004091 L 8718181004084 XL 8718181004114	61130010	REVERSIBLE: 1 PRODUCT WITH 2 DESIGNS 1.5 MM NEOPRENE THICKNESS FULL STRETCH NEOPRENE SOFT & FLEXIBLE STITCHED SEAMS
<b>SIZE</b>		<b>MASTER CARTON INFO</b>	
XS   S   M   L   XL		QUANTITY PER M. CARTON: 10 M. CARTON WEIGHT (KG): 4,7 M. CARTON WEIGHT (LBS): 10,34 M. CARTON SIZE (M): 1,02 X 0,53 X 0,11 M. CARTON SIZE (INCH): 40 X 21 X 4,5	



► 1.5 MM NEOPRENE



► SHORT FRONT ZIPPER



► FULL STRETCH NEOPRENE

**VERONA TOP 1.5MM INDIGO BLUE**

ITEM NUMBER	EAN CODE	HS CODE	FEATURES
300019202	XS 8718181004060 S 8718181004022 M 8718181004015	61130010	1.5 MM NEOPRENE THICKNESS FULL STRETCH NEOPRENE SOFT & FLEXIBLE STITCHED SEAMS
<b>SIZE</b>	L 8718181004008 XL 8718181004039	<b>MASTER CARTON INFO</b>	SHORT FRONT ZIPPER FEMININE FIT
XS   S   M   L   XL		QUANTITY PER M. CARTON: 10 M. CARTON WEIGHT (KG): 4,8 M. CARTON WEIGHT (LBS): 10,56 M. CARTON SIZE (M): 1,02 X 0,53 X 0,11 M. CARTON SIZE (INCH): 40 X 21 X 4,5	



► 2 MM NEOPRENE



► BREATHABLE BACK KNEES



► VELCRO SHOULDER ENTRY

**PORTO LONG JOHN 2MM**

ITEM NUMBER	EAN CODE	HS CODE	FEATURES
303819200	XS 8718181006118 S 8718181006095 M 8718181006088	61130010	2 MM NEOPRENE THICKNESS FULL STRETCH NEOPRENE SOFT, FLEXIBLE & BREATHABLE STITCHED SEAMS VELCRO SHOULDER ENTRY BREATHABLE BACK KNEES PROTECTIVE STRONG KNEE PADS FEMININE FIT LARGE ARMHOLES FOR MAXIMUM FREEDOM OF MOVEMENT
<b>SIZE</b>	L 8718181006071 XL 8718181006101	<b>MASTER CARTON INFO</b>	
XS   S   M   L   XL		QUANTITY PER M. CARTON: 10 M. CARTON WEIGHT (KG): 7 M. CARTON WEIGHT (LBS): 15,4 M. CARTON SIZE (M): 0,99X0,53X0,11 M. CARTON SIZE (INCH): 39X21X4,5	



► 2 MM NEOPRENE



► SOFT & FLEXIBLE STITCHED SEAMS



► FRONT ZIPPER

**PORTO JACKET 2MM**

ITEM NUMBER	EAN CODE	HS CODE	FEATURES
303819201	XS 8718181006163 S 8718181006149 M 8718181006132	61130010	2 MM NEOPRENE THICKNESS FULL STRETCH NEOPRENE SOFT, FLEXIBLE & BREATHABLE STITCHED SEAMS FRONT ZIPPER FOR FAST ENTRY FEMININE FIT
<b>SIZE</b>	L 8718181006125 XL 8718181006156	<b>MASTER CARTON INFO</b>	
XS   S   M   L   XL		QUANTITY PER M. CARTON: 10 M. CARTON WEIGHT (KG): 5,9 M. CARTON WEIGHT (LBS): 12,98 M. CARTON SIZE (M): 1,3X0,74X0,15 M. CARTON SIZE (INCH): 51X29X6	



► 3/2 MM NEOPRENE



► SOFT & FLEXIBLE STITCHED SEAMS

**SOFIA FULLSUIT 3/2MM DARK TEAL**

ITEM NUMBER	EAN CODE	HS CODE	FEATURES
303519222	S 8718181004817 M 8718181004800 L 8718181004794 XL 8718181004824	61130010	3MM NEOPRENE ON CHEST & BACK, 2MM ON OTHER PANELS FULL STRETCH NEOPRENE SOFT & FLEXIBLE STITCHED SEAMS STRENGTHENING TAPE INSIDE BACK ZIPPER FOR FAST ENTRY PROTECTIVE STRONG KNEE PADS FEMININE FIT
<b>SIZE</b>		<b>MASTER CARTON INFO</b>	
S   M   L   XL		QUANTITY PER M. CARTON: 10 M. CARTON WEIGHT (KG): 8,2 M. CARTON WEIGHT (LBS): 18,04 M. CARTON SIZE (M): 1,19 X 0,54 X 0,11 M. CARTON SIZE (INCH): 47 X 21,1 X 4,5	



► 3/2 MM NEOPRENE



► BACK ZIPPER



► FEMININE FIT

**SOFIA FULLSUIT 3/2MM HOT PINK**

ITEM NUMBER	EAN CODE	HS CODE	FEATURES
303519220	XS 8718181004749 S 8718181004725 M 8718181004718	61130010	3MM NEOPRENE ON CHEST & BACK, 2MM ON OTHER PANELS FULL STRETCH NEOPRENE SOFT & FLEXIBLE STITCHED SEAMS STRENGTHENING TAPE INSIDE BACK ZIPPER FOR FAST ENTRY PROTECTIVE STRONG KNEE PADS FEMININE FIT
<b>SIZE</b>	L 8718181004701 XL 8718181004732 2XL 8718181004695	<b>MASTER CARTON INFO</b>	
XS   S   M   L   XL   2XL		QUANTITY PER M. CARTON: 10 M. CARTON WEIGHT (KG): 8,2 M. CARTON WEIGHT (LBS): 18,04 M. CARTON SIZE (M): 1,19 X 0,54 X 0,11 M. CARTON SIZE (INCH): 47 X 21,1 X 4,5	





► 3/2 MM NEOPRENE



► BACK ZIPPER



► FEMININE FIT

**SOFIA FULLSUIT 3/2MM INDIGO BLUE**

ITEM NUMBER	EAN CODE	HS CODE	FEATURES
303519221	S 8718181004770 M 8718181004763 L 8718181004756 XL 8718181004787	61130010	3MM NEOPRENE ON CHEST & BACK, 2MM ON OTHER PANELS FULL STRETCH NEOPRENE SOFT & FLEXIBLE STITCHED SEAMS STRENGTHENING TAPE INSIDE BACK ZIPPER FOR FAST ENTRY PROTECTIVE STRONG KNEE PADS FEMININE FIT
<b>SIZE</b>		<b>MASTER CARTON INFO</b>	
S   M   L   XL		QUANTITY PER M. CARTON: 10 M. CARTON WEIGHT (KG): 8,2 M. CARTON WEIGHT (LBS): 18,04 M. CARTON SIZE (M): 1,19 X 0,54 X 0,11 M. CARTON SIZE (INCH): 47 X 21,1 X 4,5	



► CHEST ZIPPER



► WATER DRAINAGE SYSTEM



► THERMO INNER LINING

**VICTORIA FULLSUIT CHESTZIP 3/2MM**

ITEM NUMBER	EAN CODE	HS CODE	FEATURES
303519210	S 8718181004633 M 8718181004626 L 8718181004619 XL 8718181004640	61130010	3MM NEOPRENE ON CHEST & BACK, 2MM ON OTHER PANELS SUPREME STRETCH NEOPRENE GLUED & BLIND STITCHED SEAMS: NO WATER ENTRY THROUGH SEAMS STRENGTHENING TAPES INSIDE CHEST ZIPPER FOR MAX FLEX & MINIMAL WATER ENTRY WARM THERMO INNER LINING (CHEST, BACK & UPPER LEGS) PROTECTIVE STRONG KNEE PADS COMFY MINIMAL SEAM TECHNOLOGY WATER DRAINAGE SYSTEM WATER BLOCKING WRIST & ANKLE TAPE FEMININE FIT
<b>SIZE</b>		<b>MASTER CARTON INFO</b>	
S   M   L   XL		QUANTITY PER M. CARTON: 10 M. CARTON WEIGHT (KG): 11,6 M. CARTON WEIGHT (LBS): 25,52 M. CARTON SIZE (M): 1,02 X 0,56 X 0,18 M. CARTON SIZE (INCH): 40 X 22 X 7	

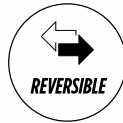

► 3/2 MM NEOPRENE



► BACK ZIPPER



► REVERSIBLE

**VICTORIA FULLSUIT 3/2MM REVERSIBLE**

ITEM NUMBER	EAN CODE	HS CODE	FEATURES
303519211	S 8718181004671 M 8718181004664 L 8718181004657 XL 8718181004688	61130010	REVERSIBLE: 1 PRODUCT WITH 2 DESIGNS 3MM NEOPRENE ON CHEST & BACK, 2MM ON OTHER PANELS SUPREME STRETCH NEOPRENE GLUED & BLIND STITCHED SEAMS: NO WATER ENTRY THROUGH SEAMS BACK ZIPPER FOR FAST ENTRY COMFY MINIMAL SEAM TECHNOLOGY FEMININE FIT
<b>SIZE</b>		<b>MASTER CARTON INFO</b>	
S   M   L   XL		QUANTITY PER M. CARTON: 10 M. CARTON WEIGHT (KG): 11,6 M. CARTON WEIGHT (LBS): 25,2 M. CARTON SIZE (M): 1,02 X 0,56 X 0,18 M. CARTON SIZE (INCH): 40 X 22 X 7	



► CHEST ZIPPER



► ADJUSTABLE & DETACHABLE ANKLE STRAPS



► THERMO INNER LINING

**ASPEN FULLSUIT CHESTZIP 5/3MM**

ITEM NUMBER	EAN CODE	HS CODE	FEATURES
303519200	S 8718181004596 M 8718181004589 L 8718181004572 XL 8718181004602 2XL 8718181004565	61130010	5MM NEOPRENE ON CHEST & BACK, 3MM ON OTHER PANELS SUPREME STRETCH NEOPRENE GLUED & BLIND STITCHED SEAMS: NO WATER ENTRY THROUGH SEAMS   NEOPRENE TAPED SEAMS INSIDE FOR MAXIMUM STRENGTH & PROTECTION   STRENGTHENING TAPE INSIDE CHEST ZIPPER FOR MAX FLEX & MINIMAL WATER ENTRY DRAINAGE THERMO INNER LINING: WARM & DRY (FULL WETSUIT)   ADJUSTABLE & DETACHABLE ANKLE STRAPS PROTECTIVE STRONG KNEE PADS COMFY MINIMAL SEAM TECHNOLOGY KEY POCKET WITH ELASTIC CORD   FEMININE FIT WATER BLOCKING WRIST CUFFS   WATER DRAINAGE SYSTEM
<b>SIZE</b>		<b>MASTER CARTON INFO</b>	
S   M   L   XL   2XL		QUANTITY PER M. CARTON: 10 M. CARTON WEIGHT (KG): 18,6 M. CARTON WEIGHT (LBS): 40,92 M. CARTON SIZE (M): 1,02 X 0,56 X 0,38 M. CARTON SIZE (INCH): 40 X 22 X 7	





► 2MM NEOPRENE



► SOFT & FLEXIBLE STITCHED SEAMS

**ATLANTA FULLSUIT 2MM**

ITEM NUMBER	EAN CODE	HS CODE	FEATURES
303517154	S 8718181217170 M 8718181217163 L 8718181217156	61130010	2 MM NEOPRENE THICKNESS REGULAR STRETCH NEOPRENE SOFT & FLEXIBLE STITCHED SEAMS STRENGTHENING TAPE INSIDE BACK ZIPPER FOR FAST ENTRY PROTECTIVE STRONG KNEE PADS
<b>SIZE</b>	XL 8718181217187 2XL 8718181217194 3XL 8718181217200	<b>MASTER CARTON INFO</b>	
S   M   L   XL   2XL   3XL		QUANTITY PER M. CARTON: 10 M. CARTON WEIGHT (KG): 12,1 M. CARTON WEIGHT (LBS): 26,62 M. CARTON SIZE (M): 1,02 X 0,56 X 0,18 M. CARTON SIZE (INCH): 40 X 22 X 7	



► 3/2 MM NEOPRENE



► SOFT & FLEXIBLE STITCHED SEAMS

**PERTH FULLSUIT 3/2MM RED**

ITEM NUMBER	EAN CODE	HS CODE	FEATURES
303517151	S 8718181216814 M 8718181216807 L 8718181216791	61130010	3MM NEOPRENE ON CHEST & BACK 2MM NEOPRENE ON OTHER PANELS FULL STRETCH NEOPRENE
<b>SIZE</b>	XL 8718181216821 2XL 8718181216838 3XL 8718181216845	<b>MASTER CARTON INFO</b>	SOFT & FLEXIBLE STITCHED SEAMS STRENGTHENING TAPE INSIDE BACK ZIPPER FOR FAST ENTRY PROTECTIVE STRONG KNEE PADS
S   M   L   XL   2XL   3XL		QUANTITY PER M. CARTON: 10 M. CARTON WEIGHT (KG): 9,9 M. CARTON WEIGHT (LBS): 21,78 M. CARTON SIZE (M): 1,02 X 0,56 X 0,18 M. CARTON SIZE (INCH): 40 X 22 X 7	



► 3/2 MM NEOPRENE



► SOFT & FLEXIBLE STITCHED SEAMS

**PERTH FULLSUIT 3/2MM BLUE**

ITEM NUMBER	EAN CODE	HS CODE	FEATURES
303517152	S 8718181216937 M 8718181216944 L 8718181216913	61130010	3MM NEOPRENE ON CHEST & BACK 2MM NEOPRENE ON OTHER PANELS FULL STRETCH NEOPRENE SOFT & FLEXIBLE STITCHED SEAMS STRENGTHENING TAPE INSIDE BACK ZIPPER FOR FAST ENTRY PROTECTIVE STRONG KNEE PADS
<b>SIZE</b>	XL 8718181216951 2XL 8718181216968 3XL 8718181216975	<b>MASTER CARTON INFO</b>	
S   M   L   XL   2XL   3XL		QUANTITY PER M. CARTON: 10 M. CARTON WEIGHT (KG): 10,1 M. CARTON WEIGHT (LBS): 22,22 M. CARTON SIZE (M): 1,02 X 0,56 X 0,18 M. CARTON SIZE (INCH): 40 X 22 X 7	





▶ 3/2 MM NEOPRENE



▶ SOFT & FLEXIBLE STITCHED SEAMS

**PERTH FULLSUIT 3/2MM GRAPHITE GREY**

ITEM NUMBER	EAN CODE	HS CODE	FEATURES
303517153	XS 8718181235389 S 8718181217057 M 8718181217040 L 8718181216920 XL 8718181217064 2XL 8718181217071 3XL 8718181217088 4XL 8718181235396	61130010	3MM NEOPRENE ON CHEST & BACK 2MM NEOPRENE ON OTHER PANELS FULL STRETCH NEOPRENE SOFT & FLEXIBLE STITCHED SEAMS STRENGTHENING TAPE INSIDE BACK ZIPPER FOR FAST ENTRY PROTECTIVE STRONG KNEE PADS
<b>SIZE</b>		<b>MASTER CARTON INFO</b>	
XS   S   M   L   XL   2XL   3XL   4XL		QUANTITY PER M. CARTON: 10 M. CARTON WEIGHT (KG): 8,6 M. CARTON WEIGHT (LBS): 18,92 M. CARTON SIZE (M): 1,02 X 0,56 X 0,18 M. CARTON SIZE (INCH): 40 X 22 X 7	



► 2 MM NEOPRENE



► BREATHABLE BACK KNEES



► VELCRO SHOULDER ENTRY

**TORONTO LONG JOHN 2MM**

ITEM NUMBER	EAN CODE	HS CODE	FEATURES
303819100	S 8718181005753 M 8718181005746 L 8718181005739	61130010	2 MM NEOPRENE THICKNESS FULL STRETCH NEOPRENE SOFT, FLEXIBLE & BREATHABLE STITCHED SEAMS VELCRO SHOULDER ENTRY BREATHABLE BACK KNEES PROTECTIVE STRONG KNEEPADS LARGE ARMHOLES FOR MAXIMUM FREEDOM OF MOVEMENT
<b>SIZE</b>	XL 8718181005760 2XL 8718181005715 3XL 8718181005722	<b>MASTER CARTON INFO</b>	
S   M   L   XL   2XL   3XL		QUANTITY PER M. CARTON: 10 M. CARTON WEIGHT (KG): 7,2 M. CARTON WEIGHT (LBS): 15,84 M. CARTON SIZE (M): 0,99X0,53X0,11 M. CARTON SIZE (INCH): 39X21X4,5	



► 2 MM NEOPRENE



► FRONT ZIPPER



► SUPREME STRETCH NEOPRENE

**TORONTO JACKET 2MM**

ITEM NUMBER	EAN CODE	HS CODE	FEATURES
303819101	S 8718181005814 M 8718181005807 L 8718181005791	61130010	2 MM NEOPRENE THICKNESS FULL STRETCH NEOPRENE SOFT, FLEXIBLE & BREATHABLE STITCHED SEAMS FRONT ZIPPER FOR FAST ENTRY
<b>SIZE</b>	XL 8718181005821 2XL 8718181005777 3XL 8718181005784	<b>MASTER CARTON INFO</b>	
S   M   L   XL   2XL   3XL		QUANTITY PER M. CARTON: 10 M. CARTON WEIGHT (KG): 6,1 M. CARTON WEIGHT (LBS): 13,42 M. CARTON SIZE (M): 1,3X0,74X0,15 M. CARTON SIZE (INCH): 51X29X6	



▶ 3/2 MM NEOPRENE



▶ CHEST ZIPPER



▶ SOFT & FLEXIBLE STITCHED SEAMS

**PERTH FULLSUIT CHESTZIP 3|2MM**

ITEM NUMBER	EAN CODE	HS CODE	FEATURES
303519120	S 8718181004541 M 8718181004534 L 8718181004527	61130010	3MM NEOPRENE ON CHEST & BACK, 2MM ON OTHER PANELS FULL STRETCH NEOPRENE SOFT & FLEXIBLE STITCHED SEAMS STRENGTHENING TAPE INSIDE CHEST ZIPPER FOR MAX FLEX & MINIMAL WATER ENTRY PROTECTIVE STRONG KNEE PADS TURN YOUR FULLSUIT IN A SHORTY: OPTIONAL CUT ABOVE KNEES
<b>SIZE</b>	XL 8718181004558 2XL 8718181004510	<b>MASTER CARTON INFO</b>	
S   M   L   XL   2XL		QUANTITY PER M. CARTON: 10 M. CARTON WEIGHT (KG): 7,4 M. CARTON WEIGHT (LBS): 16,28 M. CARTON SIZE (M): 1,02 X 0,56 X 0,18 M. CARTON SIZE (INCH): 40 X 22 X 7	



▶ 3/2 MM NEOPRENE



▶ BACK ZIPPER



▶ THERMO INNER LINING

**PORTLAND FULLSUIT 3/2MM**

ITEM NUMBER	EAN CODE	HS CODE	FEATURES
303519111	S 8718181004428 M 8718181004411 L 8718181004404 XL 8718181004442 2XL 8718181004381 3XL 8718181004398	61130010	3MM NEOPRENE ON CHEST & BACK, 2MM ON OTHER PANELS SUPREME STRETCH NEOPRENE GLUED & BLIND STITCHED SEAMS: NO WATER ENTRY THROUGH SEAMS STRENGTHENING TAPES INSIDE BACK ZIPPER FOR FAST ENTRY WATER BLOCKING SHIELD BEHIND ZIPPER WARM THERMO INNER LINING (CHEST & BACK) PROTECTIVE STRONG KNEE PADS COMFY MINIMAL SEAM TECHNOLOGY WATER DRAINAGE SYSTEM WATER BLOCKING WRIST & ANKLE TAPE
<b>SIZE</b>	S   M   L   XL   2XL   3XL	<b>MASTER CARTON INFO</b>	
		QUANTITY PER M. CARTON: 10 M. CARTON WEIGHT (KG): 13,1 M. CARTON WEIGHT (LBS): 28,82 M. CARTON SIZE (M): 1,02 X 0,56 X 0,18 M. CARTON SIZE (INCH): 40 X 22 X 7	



► PROTECTIVE STRONG KNEEPADS



► CHEST ZIPPER



► THERMO INNER LINING

**PORTLAND FULLSUIT CHESTZIP 3|2MM**

ITEM NUMBER	EAN CODE	HS CODE	FEATURES
303519110	S 8718181004336 M 8718181004312 MT 8718181004329	61130010	3MM NEOPRENE ON CHEST & BACK, 2MM ON OTHER PANELS SUPREME STRETCH NEOPRENE GLUED & BLIND STITCHED SEAMS: NO WATER ENTRY THROUGH SEAMS   STRENGTHENING TAPES INSIDE CHEST ZIPPER FOR MAX FLEX & MINIMAL WATER ENTRY WARM THERMO INNER LINING (CHEST, BACK & UPPER LEGS) AVAILABLE IN TALL LENGTH SIZES PROTECTIVE STRONG KNEE PADS   KNEES AND BINDINGS COMFY MINIMAL SEAM TECHNOLOGY WATER DRAINAGE SYSTEM WATER BLOCKING WRIST & ANKLE TAPE TURN YOUR FULLSUIT IN A SHORTY: OPTIONAL CUT ABOVE
<b>SIZE</b>	L 8718181004299 LT 8718181004305 XL 8718181004343 2XL 8718181004282	<b>MASTER CARTON INFO</b>	
S   M   MT   L   LT   XL   2XL		QUANTITY PER M. CARTON: 10 M. CARTON WEIGHT (KG): 13,1 M. CARTON WEIGHT (LBS): 28,82 M. CARTON SIZE (M): 1,02 X 0,56 X 0,18 M. CARTON SIZE (INCH): 40 X 22 X 7	



► 4/3 MM NEOPRENE



► BACK ZIPPER



► WATER BLOCKING WRIST CUFFS

**YUKON FULLSUIT 4|3MM**

ITEM NUMBER	EAN CODE	HS CODE	FEATURES
303519101	S 8718181004244 M 8718181004237 L 8718181004220 XL 8718181004275 2XL 8718181004206 3XL 8718181004213	61130010	4MM NEOPRENE ON CHEST & BACK, 3MM ON OTHER PANELS SUPREME STRETCH NEOPRENE GLUED & BLIND STITCHED SEAMS: NO WATER ENTRY THROUGH SEAMS   STRENGTHENING TAPE INSIDE BACK ZIPPER FOR FAST ENTRY WATER BLOCKING SHIELD BEHIND ZIPPER WARM THERMO INNER LINING (FULL WETSUIT) PROTECTIVE STRONG KNEE PADS COMFY MINIMAL SEAM TECHNOLOGY WATER DRAINAGE SYSTEM WATER BLOCKING WRIST CUFFS WATER BLOCKING ANKLE TAPE
<b>SIZE</b>		<b>MASTER CARTON INFO</b>	
S   M   L   XL   2XL   3XL		QUANTITY PER M. CARTON: 10 M. CARTON WEIGHT (KG): 13,5 M. CARTON WEIGHT (LBS): 29,7 M. CARTON SIZE (M): 1,02 X 0,56 X 0,18 M. CARTON SIZE (INCH): 40 X 22 X 7	



► 5/3 MM NEOPRENE



► CHEST ZIPPER



► ADJUSTABLE & DETACHABLE ANKLE STRAPS

**YUKON FULLSUIT CHESTZIP 5/3MM**

ITEM NUMBER	EAN CODE	HS CODE	FEATURES
303519100	S 8718181004183 M 8718181004169 MT 8718181004176	61130010	5MM NEOPRENE ON CHEST & BACK, 3MM ON OTHER PANELS SUPREME STRETCH NEOPRENE   GLUED & BLIND STITCHED SEAMS: NO WATER ENTRY THROUGH SEAMS   NEOPRENE TAPED SEAMS INSIDE FOR MAXIMUM STRENGTH & PROTECTION   STRENGTHENING TAPES INSIDE   CHEST ZIPPER FOR MAX FLEX & MINIMAL WATER ENTRY   ADJUSTABLE ELASTIC CORD CHEST ZIPPER CONSTRUCTION   DRAINAGE THERMO INNER LINING: WARM & DRY (FULL WETSUIT)   AVAILABLE IN TALL LENGTH SIZES   ADJUSTABLE & DETACHABLE ANKLE STRAPS   PROTECTIVE STRONG KNEE PADS   COMFY MINIMAL SEAM TECHNOLOGY   WATER DRAINAGE SYSTEM   WATER BLOCKING WRIST CUFFS   KEY POCKET WITH ELASTIC CORD
<b>SIZE</b>	L 8718181004145 LT 8718181004152 XL 8718181004190 2XL 8718181004138		
S   M   MT   L   LT   XL   2XL		<b>MASTER CARTON INFO</b>	
		QUANTITY PER M. CARTON: 10 M. CARTON WEIGHT (KG): 18,6 M. CARTON WEIGHT (LBS): 40,92 M. CARTON SIZE (M): 1,02 X 0,56 X 0,18 M. CARTON SIZE (INCH): 40 X 22 X 7	





▶ ADJUSTABLE WRIST CLOSING



▶ FULL STRETCH NEOPRENE

**NEOPRENE JACKET**

ITEM NUMBER	EAN CODE	HS CODE	FEATURES
300017550	S 8718181215169 M 8718181215152 L 8718181215145 XL 8718181215176	61130010	1.5 MM NEOPRENE THICKNESS FULL STRETCH NEOPRENE SOFT & FLEXIBLE STITCHED SEAMS WARM THERMO INNER LINING WATER REPELLENT OUTER FABRIC FRONT ZIPPER FOR FAST ENTRY ADJUSTABLE WRIST CLOSING
<b>SIZE</b>		<b>MASTER CARTON INFO</b>	
S   M   L   XL		QUANTITY PER M. CARTON: 10 M. CARTON WEIGHT (KG): 12,4 M. CARTON WEIGHT (LBS): 27,28 M. CARTON SIZE (M): 1,3X0,74X0,15 M. CARTON SIZE (INCH): 51X29X6	



Neon light and green shoots of new life brighten spring nights, as technology goes beyond digital.

Perception

Inspiration



**FOOTWEAR & ACCESSORIES**

# SIZING FOOTWEAR & ACCESSORIES

## SHOES YOUTH

AQUA SHOES YOUTH				H2O SHOES YOUTH			
SIZE	EU	LENGTH (CM)	LENGTH (INCH)	SIZE	EU	LENGTH (CM)	LENGTH (INCH)
XS	25-26	17,5	6,9	XS	23-24	16	6,3
S	27-28	19	7,5	S	25-26	17	6,7
M	29-30	20	7,9	M	27-28	18	7,1
L	31-32	21	8,3	L	29-30	20	7,9
XL	33-34	22	8,7	XL	30-31	20,5	8,1

## SUPPORT/BRACES

KNEEBRACE		
SIZE	KNEE (CM)	KNEE (INCH)
S	40-44 CM	15,7-17,3
M	43-47 CM	16,9-18,5
L	45-49 CM	17,7-19,3
XL	48-52 CM	18,9-20,5

## SHOES ADULT

H2O SHOES AND AQUA ADULT				NEOPRENE BOOTS			
US SIZE	EU	LENGTH (CM)	LENGTH (INCH)	US SIZE	EU	LENGTH (CM)	LENGTH (INCH)
3	36	21	8,3	5	36	23	9,1
4	37	22,5	8,9	6	37/38	24	9,4
5	38	23	9,1	7	39	25	9,8
6	39	24	9,4	8	40-41	26	10,2
7	40-41	25	9,8	9	42	27	10,6
8	41-42	26	10,2	10	43-44	28	11
9	43	27	10,6	11	45	29	11,4
10	44	28,5	11,2	12	46/47	30	11,8
11	45	29	11,4				
12	46	30	11,8				

## SPRAY LEG

	CALF WIDEST POINT (CM)	CALF WIDEST POINT (INCH)
S	36-38	14,2-15
M	38-40	15-15,7
L	40-42	15,7-16,5
XL	42-44	16,5-17,3

## DISCOVER SHOES

USA	5,5	6	6,5/7	7,5	8	8,5	9,5	10	11
EU	37	38	39	40	41	42	43	44	45
UK	5	5,5	6	6,5	7	7,5	8,5	9	10
INSIDE CM +/- 0,5 CM	23,3	23,96	24,63	25,36	26,03	26,7	27,36	28,03	28,69
INSIDE INCH +/- 0,2 INCH	9,17	9,43	9,7	9,98	10,25	10,5	10,77	11,04	11,3

WE ARE CONSTANTLY WORKING ON THE SIZING OF OUR PRODUCTS. CHECK OUT [JOBESPORTS.COM](http://JOBESPORTS.COM) FOR THE MOST UP TO DATE, IMPROVED SIZING! ALL MEASUREMENTS ARE FOR REFERENCE ONLY.





## WET GEAR BAG

ITEM NUMBER	EAN CODE	HS CODE	FEATURES
220017001	PCS. 8718181209489	42029291	WATERPROOF TAURPAULIN BAG 2 WEBBING HANDLES FOR EASY CARRYING KEEPS YOUR GEAR DRY
SIZE	MASTER CARTON INFO		
PCS.	QUANTITY PER M. CARTON:	20	
	M. CARTON WEIGHT (KG):	13,2	
	M. CARTON WEIGHT (LBS):	29,04	
	M. CARTON SIZE (M):	0,62X0,39X0,28	
	M. CARTON SIZE (INCH):	24,41X15,35X11,02	



### AQUA SHOES YOUTH

ITEM NUMBER	EAN CODE	HS CODE	FEATURES
534619003	XS 8718181008259 S 8718181008235 M 8718181008228	64041990	2MM NEOPRENE WATER-BLOCKING FLAT LOCK CONSTRUCTION PRE-SHAPED
<b>SIZE</b>	L 8718181008204 XL 8718181008242	<b>MASTER CARTON INFO</b>	ELASTIC ANKLE ROPE THIN PROFILED OUTSOLE FOR OPTIMAL CONTROL
XS   S   M   L   XL		QUANTITY PER M. CARTON: 20 M. CARTON WEIGHT (KG): 7,2 M. CARTON WEIGHT (LBS): 15,84 M. CARTON SIZE (M): 0,42X0,35X0,25 M. CARTON SIZE (INCH): 16,54X13,78X9,65	



### AQUA SHOES ADULT

ITEM NUMBER	EAN CODE	HS CODE	FEATURES
534619004	3 8718181008297	64041990	2MM NEOPRENE.
	4 8718181008303		WATER-BLOCKING FLAT LOCK CONSTRUCTION
	5 8718181008310		PRE-SHAPED
<b>SIZE</b>	6 8718181008327	<b>MASTER CARTON INFO</b>	ELASTIC ANKLE ROPE
	7 8718181008334		THIN PROFILED OUTSOLE FOR OPTIMAL CONTROL
3   4   5   6   7   8   9   10   11   12	8 8718181008341	QUANTITY PER M. CARTON:	20
	9 8718181008358	M. CARTON WEIGHT (KG):	11,2
	10 8718181008266	M. CARTON WEIGHT (LBS):	24,64
	11 8718181008273	M. CARTON SIZE (M):	0,5X0,42X0,32
	12 8718181008280	M. CARTON SIZE (INCH):	19,69X16,54X12,6



### H2O SHOES 2MM YOUTH

ITEM NUMBER	EAN CODE	HS CODE	FEATURES
534619002	XS 8718181008198 S 8718181008174 M 8718181008167	64041990	3MM NEOPRENE WATER-BLOCKING GLUED STITCH CONSTRUCTION PRE-SHAPED
<b>SIZE</b>	L 8718181008150 XL 8718181008181	<b>MASTER CARTON INFO</b>	ADJUSTABLE ANKLE STRAP ELASTIC ANKLE ROPE THIN PROFILED OUTSOLE FOR OPTIMAL CONTROL
XS   S   M   L   XL		QUANTITY PER M. CARTON: 20 M. CARTON WEIGHT (KG): 5,2 M. CARTON WEIGHT (LBS): 11,44 M. CARTON SIZE (M): 0,63X0,51X0,48 M. CARTON SIZE (INCH): 24,8X20,08X18,9	





### H2O SHOES 3MM GBS ADULT

ITEM NUMBER	EAN CODE	HS CODE	FEATURES
534619001	10 8718181008051 11 8718181008068 12 8718181008075	64041990	3MM NEOPRENE WATER-BLOCKING GLUED STITCH CONSTRUCTION PRE-SHAPED
<b>SIZE</b>	3 8718181008082 4 8718181008099 5 8718181008105 6 8718181008112 7 8718181008129 8 8718181008136 9 8718181008143	<b>MASTER CARTON INFO</b> QUANTITY PER M. CARTON: 20 M. CARTON WEIGHT (KG): 8,6 M. CARTON WEIGHT (LBS): 18,92 M. CARTON SIZE (M): 0,63X0,51X0,48 M. CARTON SIZE (INCH): 24,8X20,08X18,9	ADJUSTABLE ANKLE STRAP ELASTIC ANKLE ROPE THIN PROFILED OUTSOLE FOR OPTIMAL CONTROL



► QUICK DRY MATERIALS

► CUSTOM OUTSOLE WITH GRIPPY RUBBER INSERTS

**DISCOVER SLIP-ON TEAL**

ITEM NUMBER	EAN CODE	HS CODE	FEATURES
594618005	5.5 8718181262415 6 8718181262422 6/7.5 8718181262439 7.5 8718181262446 8 8718181262453 8.5 8718181262460 9.5 8718181262477 10 8718181262385 11 8718181262392	64041990	EXTREMELY LIGHTWEIGHT SHOE QUICKDRY MATERIALS OUTSOLE FEATURES RUBBER FOR EXTRA GRIP CUSTOM INSOLE OUTSOLE WITH WATER DRAINS ON THE SIDE
<b>SIZE</b>		<b>MASTER CARTON INFO</b>	
5.5   6   6/7.5   7.5   8   8.5   9.5   10   11		QUANTITY PER M. CARTON: 20 M. CARTON WEIGHT (KG): 7,7 M. CARTON WEIGHT (LBS): 16,94 M. CARTON SIZE (M): 0,94 X 0,62 X 0,35 M. CARTON SIZE (INCH): 37,01 X 24,41 X 13,78	



► QUICK DRY MATERIALS

► CUSTOM OUTSOLE WITH GRIPPY RUBBER INSERTS

**DISCOVER SLIP-ON NERO**

ITEM NUMBER	EAN CODE	HS CODE	FEATURES
594618006	5.5 8718181262613 6 8718181262620 6/7.5 8718181262637 7.5 8718181262644 8 8718181262651 8.5 8718181262668 9.5 8718181262675 10 8718181262583 11 8718181262590	64041990	EXTREMELY LIGHTWEIGHT SHOE QUICKDRY MATERIALS OUTSOLE FEATURES RUBBER FOR EXTRA GRIP CUSTOM INSOLE OUTSOLE WITH WATER DRAINS ON THE SIDE
<b>SIZE</b>		<b>MASTER CARTON INFO</b>	
5.5   6   6/7.5   7.5   8   8.5   9.5   10   11		QUANTITY PER M. CARTON: 20 M. CARTON WEIGHT (KG): 7,7 M. CARTON WEIGHT (LBS): 16,94 M. CARTON SIZE (M): 0,94 X 0,62 X 0,35 M. CARTON SIZE (INCH): 37,01 X 24,41 X 13,78	



► QUICK DRY MATERIALS

► CUSTOM OUTSOLE WITH GRIPPY RUBBER INSERTS

**DISCOVER SNEAKER TEAL**

ITEM NUMBER	EAN CODE	HS CODE	FEATURES
594618001	5.5 8718181261609 6 8718181261616 6/7.5 8718181261661 7.5 8718181261623 8 8718181261630 8.5 8718181261647 9.5 8718181261654 10 8718181261579 11 8718181261586	64041990	EXTREMELY LIGHTWEIGHT SHOE QUICKDRY MATERIALS OUTSOLE FEATURES RUBBER FOR EXTRA GRIP CUSTOM INSOLE EVA HEEL FOR DURABILITY AND DRY FAST OUTSOLE WITH WATER DRAINS ON THE SIDE
<b>SIZE</b>		<b>MASTER CARTON INFO</b>	
5.5   6   6/7.5   7.5   8   8.5   9.5   10   11		QUANTITY PER M. CARTON: 20 M. CARTON WEIGHT (KG): 17,4 M. CARTON WEIGHT (LBS): 38,28 M. CARTON SIZE (M): 0,94 X 0,62 X 0,35 M. CARTON SIZE (INCH): 37,01 X 24,41 X 13,78	



► QUICK DRY MATERIALS

► CUSTOM OUTSOLE WITH GRIPPY RUBBER INSERTS

**DISCOVER SNEAKER NERO**

ITEM NUMBER	EAN CODE	HS CODE	FEATURES
594618002	5.5 8718181261814 6 8718181261821 6/7.5 8718181261838 7.5 8718181261845 8 8718181261852 8.5 8718181261869 9.5 8718181261876 10 8718181261784 11 8718181261791	64041990	EXTREMELY LIGHTWEIGHT SHOE QUICKDRY MATERIALS OUTSOLE FEATURES RUBBER FOR EXTRA GRIP CUSTOM INSOLE EVA HEEL FOR DURABILITY AND DRY FAST OUTSOLE WITH WATER DRAINS ON THE SIDE
<b>SIZE</b>		<b>MASTER CARTON INFO</b>	
5.5   6   6/7.5   7.5   8   8.5   9.5   10   11		QUANTITY PER M. CARTON: 20 M. CARTON WEIGHT (KG): 17,2 M. CARTON WEIGHT (LBS): 37,84 M. CARTON SIZE (M): 0,94 X 0,62 X 0,35 M. CARTON SIZE (INCH): 37,01 X 24,41 X 13,78	



► QUICK DRY MATERIALS

► CUSTOM OUTSOLE WITH GRIPPY RUBBER INSERTS

**DISCOVER SNEAKER HIGH TEAL**

ITEM NUMBER	EAN CODE	HS CODE	FEATURES
594618003	5.5 8718181262019 6 8718181262026 6/7.5 8718181262033 7.5 8718181262040 8 8718181262057 8.5 8718181262064 9.5 8718181262071 10 8718181261982 11 8718181261999	64041990	EXTREMELY LIGHTWEIGHT SHOE QUICKDRY MATERIALS OUTSOLE FEATURES RUBBER FOR EXTRA GRIP CUSTOM INSOLE OUTSOLE WITH WATER DRAINS ON THE SIDE
<b>SIZE</b>		<b>MASTER CARTON INFO</b>	
5.5   6   6/7.5   7.5   8   8.5   9.5   10   11		QUANTITY PER M. CARTON: 10 M. CARTON WEIGHT (KG): 3,85 M. CARTON WEIGHT (LBS): 8,47 M. CARTON SIZE (M): 0,62X0,48X0,35 M. CARTON SIZE (INCH): 24,41X18,7X13,78	



► QUICK DRY MATERIALS

► CUSTOM OUTSOLE WITH GRIPPY RUBBER INSERTS

**DISCOVER SNEAKER HIGH NERO**

ITEM NUMBER	EAN CODE	HS CODE	FEATURES
594618004	5.5 8718181262217 6 8718181262224 6/7.5 8718181262231 7.5 8718181262248 8 8718181262255 8.5 8718181262262 9.5 8718181262279 10 8718181262187 11 8718181262194	64041990	EXTREMELY LIGHTWEIGHT SHOE QUICKDRY MATERIALS OUTSOLE FEATURES RUBBER FOR EXTRA GRIP CUSTOM INSOLE OUTSOLE WITH WATER DRAINS ON THE SIDE
<b>SIZE</b>		<b>MASTER CARTON INFO</b>	
5.5   6   6/7.5   7.5   8   8.5   9.5   10   11		QUANTITY PER M. CARTON: 10 M. CARTON WEIGHT (KG): 3,85 M. CARTON WEIGHT (LBS): 8,47 M. CARTON SIZE (M): 0,62X0,48X0,35 M. CARTON SIZE (INCH): 24,41X18,7X13,78	



**NEOPRENE SOCKS**

ITEM NUMBER	EAN CODE	HS CODE	FEATURES
300017554	S 8718181215626 M 8718181215619 L 8718181215602	61161020	3 MM NEOPRENE THICKNESS FULL STRETCH NEOPRENE GLUED & BLIND STITCHED SEAMS: NO WATER ENTRY THROUGH SEAMS PRE-CURVED SHAPE FOR OPTIMAL COMFORT UNISEX FIT
<b>SIZE</b>		<b>MASTER CARTON INFO</b>	
S   M   L		QUANTITY PER M. CARTON: 40 M. CARTON WEIGHT (KG): 4,8 M. CARTON WEIGHT (LBS): 10,56 M. CARTON SIZE (M): 0,61X0,37X0,15 M. CARTON SIZE (INCH): 24X14,5X6	





**SPRAY LEG**

<b>ITEM NUMBER</b>	<b>EAN CODE</b>	<b>HS CODE</b>	<b>FEATURES</b>
300017552	S 8718181215527 M 8718181215510 L 8718181215503	95062900	SOFT & FLEXIBLE NEOPRENE FABRIC FULL STRETCH NEOPRENE CALF SUPPORT & PROTECTION SHIN SUPPORT & PROTECTION
<b>SIZE</b>	XL 8718181215534	<b>MASTER CARTON INFO</b>	
S   M   L   XL		QUANTITY PER M. CARTON: 50 M. CARTON WEIGHT (KG): 4,5 M. CARTON WEIGHT (LBS): 9,9 M. CARTON SIZE (M): 0,35 X 0,34 X 0,5 M. CARTON SIZE (INCH): 13,58 X 13,39 X 19,49	



**KNEEBRACE**

ITEM NUMBER	EAN CODE	HS CODE	FEATURES
300017555	M 8718181215671 L 8718181215664 XL 8718181215688	95062900	SOFT & FLEXIBLE NEOPRENE FABRIC FULL STRETCH NEOPRENE KNEE SUPPORT ADJUSTABLE STRAPS FOR EXTRA SUPPORT
SIZE	MASTER CARTON INFO		
M   L   XL	QUANTITY PER M. CARTON: 20 M. CARTON WEIGHT (KG): 5,4 M. CARTON WEIGHT (LBS): 11,88 M. CARTON SIZE (M): 0,78X0,22X0,36 M. CARTON SIZE (INCH): 30,75X8,5X14		



**BACK SUPPORT**

ITEM NUMBER	EAN CODE	HS CODE	FEATURES
300017551	UNI 8718181215480	95062900	SOFT & FLEXIBLE NEOPRENE FABRIC FULL STRETCH NEOPRENE BACK SUPPORT ADJUSTABLE NEOPRENE WAIST BELT
SIZE	MASTER CARTON INFO		
UNI	QUANTITY PER M. CARTON: 50 M. CARTON WEIGHT (KG): 18 M. CARTON WEIGHT (LBS): 39,6 M. CARTON SIZE (M): 0,55 X 0,5 X 0,68 M. CARTON SIZE (INCH): 21,65 X 19,69 X 26,77		





**SWIMWEAR**

# SIZING SWIMWEAR

## MENS SPORTSWEAR

SIZE	CHEST (CM)	CHEST (INCH)	WAIST (CM)	WAIST (INCH)	HIP (CM)	HIP (INCH)	LENGTH (CM)	LENGTH (INCH)
XS	90-94	35,4-37	80-84	31,5-33,1	90-94	35,4-37	173-179	68,1-70,5
S	94-98	37-38,6	84-88	33,1-34,6	94-98	37-38,6	175-181	68,9-71,3
M	98-102	38,6-40,2	88-92	34,6-36,2	98-102	38,6-40,2	177-183	69,7-72
L	102-106	40,2-41,7	92-96	36,2-37,8	102-106	40,2-41,7	179-185	70,5-72,8
XL	106-110	41,7-43,3	96-100	37,8-39,4	106-110	41,7-43,3	181-187	71,3-73,6
2XL	111-117	43,7-46,1	101-107	39,8-42,1	111-117	43,7-46,1	183-189	72-74,4
3XL	117-123	46,1-48,4	107-113	42,1-44,5	117-123	46,1-48,4	185-191	72,8-75,2
4XL	123-129	48,4-50,8	113-119	44,5-46,9	123-129	48,4-50,8	187-193	73,6-76

## WOMENS SPORTSWEAR

SIZE	CHEST (CM)	CHEST (INCH)	WAIST (CM)	WAIST (INCH)	HIP (CM)	HIP (INCH)	LENGTH (CM)	LENGTH (INCH)
XS	84-88	33,1-34,6	68-72	26,8-28,3	90-94	35,4-37	165-171	65-67,3
S	88-92	34,6-36,2	72-76	28,3-29,9	94-98	37-38,6	167-173	65,7-68,1
M	93-99	36,6-39	77-83	30,3-32,7	99-105	39-41,3	169-175	66,5-81
L	99-105	39-41,3	83-89	32,7-35	105-111	41,3-43,7	171-177	167,3-69,7
XL	105-111	41,3-43,7	89-95	35-37,4	111-117	43,7-46,1	173-179	68,1-70,9
2XL	111-117	43,7-46,1	95-101	37,4-39,8	117-123	46,1-48,4	175-181	68,9-71,3

## YOUTH RASHGUARDS

SIZE	CHEST (CM)	CHEST (INCH)	WAIST (CM)	WAIST (INCH)	HIP (CM)	HIP (INCH)	LENGTH (CM)	LENGTH (INCH)
0/1	44-50	17,3-19,7	41-47	16,1-18,5	40-48	15,7-18,9	</> 74-80	</> 29,1-31,5
2/4	50-58	19,7-22,8	47-53	18,5-20,9	48-55	18,9-21,7	</> 98-104	</> 38,6-40,9
6/8	58-63	22,8-24,8	53-59	20,9-23,2	55-67	21,7-26,4	</> 116-128	</> 45,7-81
10/12	63-76	24,8-29,9	59-69	23,2-27,2	67-79	26,4-31,1	</> 140-152	</> 55,1-59,8
14/16	76-89	29,9-35	69-78	27,2-30,7	79-91	31,1-35,8	</> 164-176	</> 64,6-69,3

## YOUTH BOARDSHORTS

SIZE	CHEST (CM)	CHEST (INCH)	WAIST (CM)	WAIST (INCH)	HIP (CM)	HIP (INCH)	LENGTH (CM)	LENGTH (INCH)
0/1	44-50	17,3-19,7	41-47	16,1-18,5	40-48	15,7-18,9	</> 74-80	</> 29,1-31,5
2/4	50-58	19,7-22,8	47-53	18,5-20,9	48-55	18,9-21,7	</> 98-104	</> 38,6-40,9
6/8	58-63	22,8-24,8	53-59	20,9-23,2	55-67	21,7-26,4	</> 116-128	</> 45,7-50,4
10/12	63-76	24,8-29,9	59-69	23,2-27,2	67-79	26,4-31,1	</> 140-152	</> 55,1-59,8
14/16	76-89	29,9-35	69-78	27,2-30,7	79-91	31,1-35,8	</> 164-176	</> 64,6-69,3

WE ARE CONSTANTLY WORKING ON THE SIZING OF OUR PRODUCTS. CHECK OUT [JOBESPORTS.COM](https://www.jobesports.com) FOR THE MOST UP TO DATE, IMPROVED SIZING!  
ALL MEASUREMENTS ARE FOR REFERENCE ONLY.





► IMPROVED SIZING



► UPF 50+



► LIGHT QUICK DRYING FABRIC

**RASHGUARD GIRLS**

ITEM NUMBER	EAN CODE	HS CODE	FEATURES
544218051	0/1 8718181260329 2/4 8718181260336 6/8 8718181260343	61099020	ULTRAVIOLET PROTECTION FACTOR 50+ FOUR-WAY STRETCH FABRIC LIGHT QUICK DRYING FABRIC IMPROVED SIZING & FIT
<b>SIZE</b>	10/12 8718181260350 14/16 8718181260367	<b>MASTER CARTON INFO</b>	
0/1   2/4   6/8   10/12   14/16		QUANTITY PER M. CARTON: 50 M. CARTON WEIGHT (KG): 3 M. CARTON WEIGHT (LBS): 6,6 M. CARTON SIZE (M): 0,4X0,3X0,3 M. CARTON SIZE (INCH): 15,75X11,81X11,81	



► FOUR-WAY STRETCH FABRIC



► UPF 50+



► LIGHT QUICK DRYING FABRIC

**RASHGUARD BOYS**

ITEM NUMBER	EAN CODE	HS CODE	FEATURES
544218050	0/1 8718181260190 2/4 8718181260206 6/8 8718181260213	61099020	ULTRAVIOLET PROTECTION FACTOR 50+ FOUR-WAY STRETCH FABRIC LIGHT QUICK DRYING FABRIC IMPROVED SIZING & FIT
<b>SIZE</b>	10/12 8718181260220 14/16 8718181260237	<b>MASTER CARTON INFO</b>	
0/1   2/4   6/8   10/12   14/16		QUANTITY PER M. CARTON: 50 M. CARTON WEIGHT (KG): 3 M. CARTON WEIGHT (LBS): 6,6 M. CARTON SIZE (M): 0,4X0,3X0,3 M. CARTON SIZE (INCH): 15,75X11,81X11,81	





► UPF 50+



► FOUR-WAY STRETCH FABRIC

**RASHGUARD SHORTSLEEVE WOMEN V-NECK**

ITEM NUMBER	EAN CODE	HS CODE	FEATURES
544119010	XS 8718181008754 S 8718181008730 M 8718181008723	61099020	ULTRAVIOLET PROTECTION 50+ STITCHED CONSTRUCTION FOUR-WAY STRETCH FABRIC
<b>SIZE</b>	L 8718181008716 XL 8718181008747	<b>MASTER CARTON INFO</b>	
XS   S   M   L   XL		QUANTITY PER M. CARTON: 50 M. CARTON WEIGHT (KG): 8 M. CARTON WEIGHT (LBS): 17,6 M. CARTON SIZE (M): 0,4X0,3X0,3 M. CARTON SIZE (INCH): 15,75X11,81X11,81	



► IMPROVED SIZING



► UPF 50+

**RASHGUARD WOMEN WHITE**

ITEM NUMBER	EAN CODE	HS CODE	FEATURES
544117051	XS 8718181223935 S 8718181223911 M 8718181223904	61099020	ULTRAVIOLET PROTECTION FACTOR 50+ FOUR-WAY STRETCH FABRIC LIGHT QUICK DRYING FABRIC IMPROVED SIZING & FIT
<b>SIZE</b>	L 8718181223898 XL 8718181223928	<b>MASTER CARTON INFO</b>	
XS   S   M   L   XL		QUANTITY PER M. CARTON: 50 M. CARTON WEIGHT (KG): 8,5 M. CARTON WEIGHT (LBS): 18,7 M. CARTON SIZE (M): 0,4X0,3X0,3 M. CARTON SIZE (INCH): 15,75X11,81X11,81	



► IMPROVED SIZING



► UPF 50+

**RASHGUARD WOMEN BLACK**

ITEM NUMBER	EAN CODE	HS CODE	FEATURES
544117050	XS 8718181223829 S 8718181223805 M 8718181223799	61099020	ULTRAVIOLET PROTECTION FACTOR 50+ FOUR-WAY STRETCH FABRIC LIGHT QUICK DRYING FABRIC IMPROVED SIZING & FIT
<b>SIZE</b>	L 8718181223782 XL 8718181223812 2XL 8718181223836	<b>MASTER CARTON INFO</b>	
XS   S   M   L   XL   2XL		QUANTITY PER M. CARTON: 50 M. CARTON WEIGHT (KG): 8,5 M. CARTON WEIGHT (LBS): 18,7 M. CARTON SIZE (M): 0,4X0,3X0,3 M. CARTON SIZE (INCH): 15,75X11,81X11,81	





► UPF 50+



► FOUR-WAY STRETCH FABRIC

**RASHGUARD SHORTSLEEVE MEN DARK TEAL**

ITEM NUMBER	EAN CODE	HS CODE	FEATURES
544019001	S 8718181008556 M 8718181008549 L 8718181008532	61099020	ULTRAVIOLET PROTECTION FACTOR 50+ FOUR-WAY STRETCH FABRIC LIGHT QUICK DRYING FABRIC BOARDSHORTS CONNECTOR LOOP IMPROVED SIZING & FIT
<b>SIZE</b>	XL 8718181008563 2XL 8718181008525	<b>MASTER CARTON INFO</b>	
S   M   L   XL   2XL		QUANTITY PER M. CARTON: 50 M. CARTON WEIGHT (KG): 10 M. CARTON WEIGHT (LBS): 22 M. CARTON SIZE (M): 0,4X0,3X0,3 M. CARTON SIZE (INCH): 15,75X11,81X11,81	



► LIGHT QUICK DRYING FABRIC



► UPF 50+

**RASHGUARD MEN BLACK**

ITEM NUMBER	EAN CODE	HS CODE	FEATURES
544018022	S 8718181252911 M 8718181252904 L 8718181252898	61099020	ULTRAVIOLET PROTECTION FACTOR 50+ FOUR-WAY STRETCH FABRIC LIGHT QUICK DRYING FABRIC BOARDSHORTS CONNECTOR LOOP IMPROVED SIZING & FIT
<b>SIZE</b>	XL 8718181252935 2XL 8718181252942 3XL 8718181259583	<b>MASTER CARTON INFO</b>	
S   M   L   XL   2XL   3XL		QUANTITY PER M. CARTON: 50 M. CARTON WEIGHT (KG): 10 M. CARTON WEIGHT (LBS): 22 M. CARTON SIZE (M): 0,4X0,3X0,3 M. CARTON SIZE (INCH): 15,75X11,81X11,81	



► UPF 50+



► LIGHT QUICK DRYING FABRIC

**RASHGUARD MEN WHITE**

ITEM NUMBER	EAN CODE	HS CODE	FEATURES
544017050	S 8718181223447 M 8718181223430 L 8718181223423	61099020	ULTRAVIOLET PROTECTION FACTOR 50+ FOUR-WAY STRETCH FABRIC LIGHT QUICK DRYING FABRIC BOARDSHORTS CONNECTOR LOOP IMPROVED SIZING & FIT
<b>SIZE</b>	XL 8718181223454 2XL 8718181223461 3XL 8718181238939	<b>MASTER CARTON INFO</b>	
S   M   L   XL   2XL   3XL		QUANTITY PER M. CARTON: 50 M. CARTON WEIGHT (KG): 14,5 M. CARTON WEIGHT (LBS): 31,9 M. CARTON SIZE (M): 0,4X0,3X0,3 M. CARTON SIZE (INCH): 15,75X11,81X11,81	



► LIGHT QUICK DRYING FABRIC

► IMPROVED SIZING

**RASHGUARD LOOSE FIT MEN GRAPHITE**

ITEM NUMBER	EAN CODE	HS CODE	FEATURES
544017020	S 8718181223645 M 8718181223638 L 8718181223621 XL 8718181223652	61099020	ULTRAVIOLET PROTECTION FACTOR 20 FOUR-WAY STRETCH FABRIC BREATHABLE FABRIC LIGHT QUICK DRYING FABRIC IMPROVED SIZING & FIT
<b>SIZE</b>		<b>MASTER CARTON INFO</b>	
S   M   L   XL		QUANTITY PER M. CARTON: 20 M. CARTON WEIGHT (KG): 3,8 M. CARTON WEIGHT (LBS): 8,36 M. CARTON SIZE (M): 0,35 X 0,25 X 0,2 M. CARTON SIZE (INCH): 13,78 X 9,84 X 7,87	





► UPF 50+

**RASHGUARD LONGSLEEVE MEN**

ITEM NUMBER	EAN CODE	HS CODE	FEATURES
544017052	S 8718181235280 M 8718181235273 L 8718181235266 XL 8718181235297	61099020	ULTRAVIOLET PROTECTION FACTOR 50+ FOUR-WAY STRETCH FABRIC LIGHT QUICK DRYING FABRIC BOARDSHORTS CONNECTOR LOOP IMPROVED SIZING & FIT
<b>SIZE</b>		<b>MASTER CARTON INFO</b>	
S   M   L   XL		QUANTITY PER M. CARTON: 50 M. CARTON WEIGHT (KG): 11 M. CARTON WEIGHT (LBS): 24,2 M. CARTON SIZE (M): 0,4X0,3X0,3 M. CARTON SIZE (INCH): 15,75X11,81X11,81	



► DRAW CORD



► FOUR-WAY STRETCH FABRIC

**BOARDSHORT GIRLS TEAL BLUE**

ITEM NUMBER	EAN CODE	HS CODE	FEATURES
314218002	6 8718181259859 8 8718181259866 10 8718181259873	61124190	FOUR-WAY STRETCH FABRIC LIGHT QUICK DRYING FABRIC DRAW CORD IMPROVED SIZING & FIT
<b>SIZE</b>	12 8718181259880 14 8718181259897	<b>MASTER CARTON INFO</b>	
6   8   10   12   14		QUANTITY PER M. CARTON: 40 M. CARTON WEIGHT (KG): 3,2 M. CARTON WEIGHT (LBS): 7,04 M. CARTON SIZE (M): 0,4X0,3X0,3 M. CARTON SIZE (INCH): 15,75X11,81X11,81	



► IMPROVED SIZING & FIT



► LIGHT QUICK DRYING FABRIC

**SWIMSHORT BOYS BLUE**

ITEM NUMBER	EAN CODE	HS CODE	FEATURES
314218001	6 8718181259156	61123190	LIGHT QUICK DRYING FABRIC
	8 8718181259170		DRAW CORD
	10 8718181259194		MESH INNER SHORTS
<b>SIZE</b>	12 8718181259217	<b>MASTER CARTON INFO</b>	IMPROVED SIZING & FIT
6   8   10   12   14	14 8718181259231	QUANTITY PER M. CARTON: 40	
		M. CARTON WEIGHT (KG): 4,4	
		M. CARTON WEIGHT (LBS): 9,68	
		M. CARTON SIZE (M): 0,4X0,3X0,3	
		M. CARTON SIZE (INCH): 15,75X11,81X11,81	



**MIX  
AND  
MATCH**





► FOUR-WAY STRETCH FABRIC



► BACKPOCKET

**SWIMSHORT WOMEN**

ITEM NUMBER	EAN CODE	HS CODE	FEATURES
314118040	XS 8718181246156 S 8718181246132 M 8718181246125	61124190	ULTRAVIOLET PROTECTION FACTOR 50+ FOUR-WAY STRETCH FABRIC BACKPOCKET
<b>SIZE</b>	L 8718181246118 XL 8718181246149	<b>MASTER CARTON INFO</b>	LIGHT QUICK DRYING FABRIC IMPROVED SIZING & FIT
XS   S   M   L   XL		QUANTITY PER M. CARTON: 40 M. CARTON WEIGHT (KG): 4,4 M. CARTON WEIGHT (LBS): 9,68 M. CARTON SIZE (M): 0,4X0,3X0,3 M. CARTON SIZE (INCH): 15,75X11,81X11,81	



► LIGHT QUICK DRYING FABRIC



► DRAW CORD

**BOARDSHORTS WOMEN BORDEAUX RED**

ITEM NUMBER	EAN CODE	HS CODE	FEATURES
314119000	XS 8718181006545 S 8718181006521 M 8718181006514	61124190	LIGHT QUICK DRYING FABRIC DRAW CORD BACKPOCKET MESH INNER SHORTS IMPROVED SIZING & FIT
<b>SIZE</b>	L 8718181006507 XL 8718181006538	<b>MASTER CARTON INFO</b>	
XS   S   M   L   XL		QUANTITY PER M. CARTON: 40 M. CARTON WEIGHT (KG): 4 M. CARTON WEIGHT (LBS): 8,8 M. CARTON SIZE (M): 0,4X0,3X0,3 M. CARTON SIZE (INCH): 15,75X11,81X11,81	



► LIGHT QUICK DRYING FABRIC



► DRAW CORD

**BOARDSHORTS WOMEN BLACK**

ITEM NUMBER	EAN CODE	HS CODE	FEATURES
314119001	XS 8718181014021 S 8718181014007 M 8718181013994	61124190	LIGHT QUICK DRYING FABRIC DRAW CORD BACKPOCKET MESH INNER SHORTS IMPROVED SIZING & FIT
<b>SIZE</b>	L 8718181013987 XL 8718181014014	<b>MASTER CARTON INFO</b>	
XS   S   M   L   XL		QUANTITY PER M. CARTON: 40 M. CARTON WEIGHT (KG): 4 M. CARTON WEIGHT (LBS): 8,8 M. CARTON SIZE (M): 0,4X0,3X0,3 M. CARTON SIZE (INCH): 15,75X11,81X11,81	



► BACKPOCKET

► DRAW CORD

**SWIMSHORT MEN COBALT BLUE**

ITEM NUMBER	EAN CODE	HS CODE	FEATURES
314018002	S 8718181250290 M 8718181250283 L 8718181250276	61123190	LIGHT QUICK DRYING FABRIC DRAW CORD BACKPOCKET MESH INNER SHORTS IMPROVED SIZING & FIT
<b>SIZE</b>	XL 8718181250313 2XL 8718181250320	<b>MASTER CARTON INFO</b>	
S   M   L   XL   2XL		QUANTITY PER M. CARTON: 40 M. CARTON WEIGHT (KG): 7,2 M. CARTON WEIGHT (LBS): 15,84 M. CARTON SIZE (M): 0,4X0,3X0,3 M. CARTON SIZE (INCH): 15,75X11,81X11,81	





► BACKPOCKET



► LIGHT QUICK DRYING FABRIC

**SWIMSHORT MEN SUNNY LIME GREEN**

ITEM NUMBER	EAN CODE	HS CODE	FEATURES
314018001	S 8718181250184 M 8718181250177 L 8718181250160	61123190	LIGHT QUICK DRYING FABRIC DRAW CORD BACKPOCKET
<b>SIZE</b>	XL 8718181250207 2XL 8718181250214	<b>MASTER CARTON INFO</b>	MESH INNER SHORTS IMPROVED SIZING & FIT
S   M   L   XL   2XL		QUANTITY PER M. CARTON: 40 M. CARTON WEIGHT (KG): 9,6 M. CARTON WEIGHT (LBS): 21,12 M. CARTON SIZE (M): 0,4X0,3X0,3 M. CARTON SIZE (INCH): 15,75X11,81X11,81	



► BACKPOCKET



► LIGHT QUICK DRYING FABRIC

**SWIMSHORT MEN GRAPHITE GREY**

ITEM NUMBER	EAN CODE	HS CODE	FEATURES
314018003	S 8718181256186 M 8718181256179 L 8718181256162	61123190	LIGHT QUICK DRYING FABRIC DRAW CORD BACKPOCKET MESH INNER SHORTS IMPROVED SIZING & FIT
<b>SIZE</b>	XL 8718181256193 2XL 8718181256209	<b>MASTER CARTON INFO</b>	
S   M   L   XL   2XL		QUANTITY PER M. CARTON: 40 M. CARTON WEIGHT (KG): 7,2 M. CARTON WEIGHT (LBS): 15,84 M. CARTON SIZE (M): 0,4X0,3X0,3 M. CARTON SIZE (INCH): 15,75X11,81X11,81	



► DRAW CORD



► LIGHT QUICK DRYING FABRIC

**BOARDSHORT MEN STONE BLUE**

ITEM NUMBER	EAN CODE	HS CODE	FEATURES
314018021	S 8718181250498 M 8718181250481 L 8718181250474 XL 8718181250511	61123190	LIGHT QUICK DRYING FABRIC DRAW CORD MESH INNER SHORTS IMPROVED SIZING & FIT COMFORTABLE STRETCH FABRIC
<b>SIZE</b>		<b>MASTER CARTON INFO</b>	
S   M   L   XL		QUANTITY PER M. CARTON: 40 M. CARTON WEIGHT (KG): 5,6 M. CARTON WEIGHT (LBS): 12,32 M. CARTON SIZE (M): 0,4X0,3X0,3 M. CARTON SIZE (INCH): 15,75X11,81X11,81	



► DRAW CORD



► LIGHT QUICK DRYING FABRIC

**BOARDSHORT MEN BLACK**

ITEM NUMBER	EAN CODE	HS CODE	FEATURES
314018020	S 8718181250405 M 8718181250399 L 8718181250382 XL 8718181250429	61123190	LIGHT QUICK DRYING FABRIC DRAW CORD MESH INNER SHORTS IMPROVED SIZING & FIT COMFORTABLE STRETCH FABRIC
<b>SIZE</b>		<b>MASTER CARTON INFO</b>	
S   M   L   XL		QUANTITY PER M. CARTON: 40 M. CARTON WEIGHT (KG): 6 M. CARTON WEIGHT (LBS): 13,2 M. CARTON SIZE (M): 0,4X0,3X0,3 M. CARTON SIZE (INCH): 15,75X11,81X11,81	



**DISCOVER CLOTHING**



**QUICK  
DRY  
FABRIC**





► QUICK DRY FABRIC



► BREATHABLE MESH PANELS

**DISCOVER SPORTSTOP WOMEN BLACK**

ITEM NUMBER	EAN CODE	HS CODE	FEATURES
595119210	S 8718181010634 M 8718181010627 L 8718181010610 XL 8718181010641	61130010	FASHION MEETS FUNCTION ULTRAVIOLET PROTECTION FACTOR 50+ STRETCH FABRIC LIGHT QUICK DRYING FABRIC PERMANENT TECHNICAL FABRIC
<b>SIZE</b>		<b>MASTER CARTON INFO</b>	
S   M   L   XL		QUANTITY PER M. CARTON: 50 M. CARTON WEIGHT (KG): 6 M. CARTON WEIGHT (LBS): 13,2 M. CARTON SIZE (M): 0,4X0,3X0,3 M. CARTON SIZE (INCH): 15,75X11,81X11,81	



► BREATHABLE FABRIC

**DISCOVER T-SHIRT WOMEN DARK GREY**

ITEM NUMBER	EAN CODE	HS CODE	FEATURES
595119200	S 8718181010511 M 8718181010504 L 8718181010498 XL 8718181010528	61099020	FASHION MEETS FUNCTION ULTRAVIOLET PROTECTION FACTOR 50+ STRETCH FABRIC BREATHABLE FABRIC LIGHT QUICK DRYING FABRIC COOLING FABRIC PERMANENT TECHNICAL FABRIC
<b>SIZE</b>		<b>MASTER CARTON INFO</b>	
S   M   L   XL		QUANTITY PER M. CARTON: 50 M. CARTON WEIGHT (KG): 6 M. CARTON WEIGHT (LBS): 13,2 M. CARTON SIZE (M): 0,4X0,3X0,3 M. CARTON SIZE (INCH): 15,75X11,81X11,81	





► 1.5 MM NEOPRENE

**DISCOVER T-SHIRT WOMEN LIGHT GREY**

ITEM NUMBER	EAN CODE	HS CODE	FEATURES
595119201	S 8718181010559 M 8718181010542 L 8718181010535 XL 8718181010566	61099020	FASHION MEETS FUNCTION ULTRAVIOLET PROTECTION FACTOR 50+ STRETCH FABRIC BREATHABLE FABRIC LIGHT QUICK DRYING FABRIC COOLING FABRIC PERMANENT TECHNICAL FABRIC
<b>SIZE</b>		<b>MASTER CARTON INFO</b>	
S   M   L   XL		QUANTITY PER M. CARTON: 50 M. CARTON WEIGHT (KG): 6 M. CARTON WEIGHT (LBS): 13,2 M. CARTON SIZE (M): 0,4X0,3X0,3 M. CARTON SIZE (INCH): 15,75X11,81X11,81	



► 4 WAY STRETCH FABRIC



► QUICK DRY FABRIC

**DISCOVER SHORT WOMEN DENIM BLUE**

ITEM NUMBER	EAN CODE	HS CODE	FEATURES
594519210	S 8718181010238 M 8718181010221 L 8718181010214 XL 8718181010245	62034319	FASHION MEETS FUNCTION: STRETCH FABRIC LIGHT QUICK DRYING FABRIC PERMANENT TECHNICAL FABRIC
<b>SIZE</b>		<b>MASTER CARTON INFO</b>	
S   M   L   XL		QUANTITY PER M. CARTON: 50 M. CARTON WEIGHT (KG): 11 M. CARTON WEIGHT (LBS): 24,2 M. CARTON SIZE (M): 0,4X0,3X0,3 M. CARTON SIZE (INCH): 15,75X11,81X11,81	



► 4 WAY STRETCH FABRIC



► QUICK DRY FABRIC

**DISCOVER SHORT WOMEN ARMY GREEN**

ITEM NUMBER	EAN CODE	HS CODE	FEATURES
594519211	S 8718181010276 M 8718181010269 L 8718181010252 XL 8718181010283	62034319	FASHION MEETS FUNCTION STRETCH FABRIC LIGHT QUICK DRYING FABRIC PERMANENT TECHNICAL FABRIC
<b>SIZE</b>		<b>MASTER CARTON INFO</b>	
S   M   L   XL		QUANTITY PER M. CARTON: 50 M. CARTON WEIGHT (KG): 11 M. CARTON WEIGHT (LBS): 24,2 M. CARTON SIZE (M): 0,4X0,3X0,3 M. CARTON SIZE (INCH): 15,75X11,81X11,81	



► BREATHABLE FABRIC

**DISCOVER T-SHIRT WOMEN BLUE**

ITEM NUMBER	EAN CODE	HS CODE	FEATURES
595119202	S 8718181010597 M 8718181010580 L 8718181010573 XL 8718181010603	61099020	FASHION MEETS FUNCTION ULTRAVIOLET PROTECTION FACTOR 50+ STRETCH FABRIC BREATHABLE FABRIC LIGHT QUICK DRYING FABRIC COOLING FABRIC PERMANENT TECHNICAL FABRIC
<b>SIZE</b>		<b>MASTER CARTON INFO</b>	
S   M   L   XL		QUANTITY PER M. CARTON: 50 M. CARTON WEIGHT (KG): 6 M. CARTON WEIGHT (LBS): 13,2 M. CARTON SIZE (M): 0,4X0,3X0,3 M. CARTON SIZE (INCH): 15,75X11,81X11,81	



► BREATHABLE MESH PANELS



► 4 WAY STRETCH FABRIC



► QUICK DRY FABRIC



► WATER DRAINS

**DISCOVER LEGGING WOMEN GREEN MARBLE**

ITEM NUMBER	EAN CODE	HS CODE	FEATURES
594519220	XS 8718181010337 S 8718181010313 M 8718181010306	61130010	FASHION MEETS FUNCTION FOUR-WAY STRETCH FABRIC BACK KNEE BREATHABLE MESH LIGHT QUICK DRYING FABRIC QUICK DRY ANKLE PANELS PERMANENT TECHNICAL FABRIC
<b>SIZE</b>	L 8718181010290 XL 8718181010320	<b>MASTER CARTON INFO</b>	
XS   S   M   L   XL		QUANTITY PER M. CARTON: 50 M. CARTON WEIGHT (KG): 11 M. CARTON WEIGHT (LBS): 24,2 M. CARTON SIZE (M): 0,4X0,3X0,3 M. CARTON SIZE (INCH): 15,75X11,81X11,81	



► QUICK DRY FABRIC

**DISCOVER HOODIE WOMEN BLACK**

ITEM NUMBER	EAN CODE	HS CODE	FEATURES
595219200	S 8718181010818 M 8718181010801 L 8718181010795 XL 8718181010825	61013090	FASHION MEETS FUNCTION DRAWCORD FRONT POCKET
<b>SIZE</b>		<b>MASTER CARTON INFO</b>	
S   M   L   XL		QUANTITY PER M. CARTON: 20 M. CARTON WEIGHT (KG): 11,4 M. CARTON WEIGHT (LBS): 25,08 M. CARTON SIZE (M): 0,6X0,4X0,2 M. CARTON SIZE (INCH): 23,62X15,75X7,87	



► QUICK DRY FABRIC

### DISCOVER HOODIE WOMEN BORDEAUX RED

ITEM NUMBER	EAN CODE	HS CODE	FEATURES
595219201	S 8718181010856 M 8718181010849 L 8718181010832 XL 8718181010863	61013090	FASHION MEETS FUNCTION DRAWCORD FRONT POCKET
<b>SIZE</b>		<b>MASTER CARTON INFO</b>	
S   M   L   XL		QUANTITY PER M. CARTON: 20 M. CARTON WEIGHT (KG): 11,4 M. CARTON WEIGHT (LBS): 25,08 M. CARTON SIZE (M): 0,6X0,4X0,2 M. CARTON SIZE (INCH): 23,62X15,75X7,87	



► THUMB HOLE SLEEVE



► WATERPROOF FABRIC



► PERMANENT TECHNICAL FABRIC



► WINDPROOF FABRIC

**DISCOVER WINDJACKET WOMEN BLACK**

ITEM NUMBER	EAN CODE	HS CODE	FEATURES
595319200	S 8718181011006 M 8718181010993 L 8718181010986 XL 8718181011013	62011310	FASHION MEETS FUNCTION PERMANENT TECHNICAL FABRIC WINDPROOF FABRIC WATERPROOF FABRIC THUMB HOLE SLEEVE
<b>SIZE</b>		<b>MASTER CARTON INFO</b>	
S   M   L   XL		QUANTITY PER M. CARTON: 35 M. CARTON WEIGHT (KG): 18,55 M. CARTON WEIGHT (LBS): 40,81 M. CARTON SIZE (M): 0,6X0,4X0,4 M. CARTON SIZE (INCH): 23,62X15,75X15,75	





► THUMB HOLE SLEEVE



► WATERPROOF FABRIC



► PERMANENT TECHNICAL FABRIC



► WINDPROOF FABRIC

**DISCOVER WINDJACKET WOMEN BORDEAUX RED**

ITEM NUMBER	EAN CODE	HS CODE	FEATURES
595319201	S 8718181011044 M 8718181011037 L 8718181011020 XL 8718181011051	62011310	FASHION MEETS FUNCTION PERMANENT TECHNICAL FABRIC WINDPROOF FABRIC WATERPROOF FABRIC THUMB HOLE SLEEVE
<b>SIZE</b>		<b>MASTER CARTON INFO</b>	
S   M   L   XL		QUANTITY PER M. CARTON: 35 M. CARTON WEIGHT (KG): 18,55 M. CARTON WEIGHT (LBS): 40,81 M. CARTON SIZE (M): 0,6X0,4X0,4 M. CARTON SIZE (INCH): 23,62X15,75X15,75	



► BREATHABLE FABRIC



► QUICK DRY STRETCH FABRIC

**DISCOVER T-SHIRT MEN DARK GREY**

ITEM NUMBER	EAN CODE	HS CODE	FEATURES
595119100	S 8718181010375 M 8718181010368 L 8718181010351	61099020	FASHION MEETS FUNCTION ULTRAVIOLET PROTECTION FACTOR 50+ STRETCH FABRIC BREATHABLE FABRIC LIGHT QUICK DRYING FABRIC COOLING FABRIC PERMANENT TECHNICAL FABRIC
<b>SIZE</b>	XL 8718181010382 2XL 8718181010344	<b>MASTER CARTON INFO</b>	
S   M   L   XL   2XL		QUANTITY PER M. CARTON: 50 M. CARTON WEIGHT (KG): 6,5 M. CARTON WEIGHT (LBS): 14,3 M. CARTON SIZE (M): 0,4X0,3X0,3 M. CARTON SIZE (INCH): 15,75X11,81X11,81	



► BREATHABLE FABRIC



► QUICK DRY STRETCH FABRIC

**DISCOVER T-SHIRT MEN LIGHT GREY**

ITEM NUMBER	EAN CODE	HS CODE	FEATURES
595119101	S 8718181010429 M 8718181010412 L 8718181010405	61099020	FASHION MEETS FUNCTION ULTRAVIOLET PROTECTION FACTOR 50+ STRETCH FABRIC
<b>SIZE</b>	XL 8718181010436 2XL 8718181010399	<b>MASTER CARTON INFO</b>	BREATHABLE FABRIC LIGHT QUICK DRYING FABRIC COOLING FABRIC PERMANENT TECHNICAL FABRIC
S   M   L   XL   2XL		QUANTITY PER M. CARTON: 50 M. CARTON WEIGHT (KG): 6,5 M. CARTON WEIGHT (LBS): 14,3 M. CARTON SIZE (M): 0,4X0,3X0,3 M. CARTON SIZE (INCH): 15,75X11,81X11,81	



► BREATHABLE FABRIC



► QUICK DRY STRETCH FABRIC

**DISCOVER T-SHIRT MEN BLUE**

ITEM NUMBER	EAN CODE	HS CODE	FEATURES
595119102	S 8718181010474 M 8718181010467 L 8718181010450	61099020	FASHION MEETS FUNCTION ULTRAVIOLET PROTECTION FACTOR 50+ STRETCH FABRIC BREATHABLE FABRIC LIGHT QUICK DRYING FABRIC COOLING FABRIC PERMANENT TECHNICAL FABRIC
<b>SIZE</b>	XL 8718181010481 2XL 8718181010443	<b>MASTER CARTON INFO</b>	
S   M   L   XL   2XL		QUANTITY PER M. CARTON: 50 M. CARTON WEIGHT (KG): 6,5 M. CARTON WEIGHT (LBS): 14,3 M. CARTON SIZE (M): 0,4X0,3X0,3 M. CARTON SIZE (INCH): 15,75X11,81X11,81	



► 4 WAY STRETCH FABRIC



► QUICK DRY FABRIC

**DISCOVER SHORT MEN ARMY GREEN**

ITEM NUMBER	EAN CODE	HS CODE	FEATURES
594519110	S 8718181013406 M 8718181013390 L 8718181013383	62034319	FASHION MEETS FUNCTION STRETCH FABRIC LIGHT QUICK DRYING FABRIC PERMANENT TECHNICAL FABRIC
<b>SIZE</b>	XL 8718181013420 2XL 8718181013376	<b>MASTER CARTON INFO</b>	
S   M   L   XL   2XL		QUANTITY PER M. CARTON: 50 M. CARTON WEIGHT (KG): 12 M. CARTON WEIGHT (LBS): 26,4 M. CARTON SIZE (M): 0,4X0,3X0,3 M. CARTON SIZE (INCH): 15,75X11,81X11,81	



► 4 WAY STRETCH FABRIC



► QUICK DRY FABRIC

**DISCOVER SHORT MEN DENIM BLUE**

ITEM NUMBER	EAN CODE	HS CODE	FEATURES
594519111	S 8718181010122 M 8718181010115 L 8718181010108	62034319	FASHION MEETS FUNCTION STRETCH FABRIC LIGHT QUICK DRYING FABRIC PERMANENT TECHNICAL FABRIC
<b>SIZE</b>	XL 8718181010139 2XL 8718181010092	<b>MASTER CARTON INFO</b>	
S   M   L   XL   2XL		QUANTITY PER M. CARTON: 50 M. CARTON WEIGHT (KG): 12 M. CARTON WEIGHT (LBS): 26,4 M. CARTON SIZE (M): 0,4X0,3X0,3 M. CARTON SIZE (INCH): 15,75X11,81X11,81	



► QUICK DRY FABRIC

**DISCOVER HOODIE MEN BLACK**

ITEM NUMBER	EAN CODE	HS CODE	FEATURES
595219100	S 8718181010726 M 8718181010719 L 8718181010702 XL 8718181010733 2XL 8718181010696	61013090	FASHION MEETS FUNCTION DRAWCORD FRONT POCKET
<b>SIZE</b>		<b>MASTER CARTON INFO</b>	
S   M   L   XL   2XL		QUANTITY PER M. CARTON: 20 M. CARTON WEIGHT (KG): 12,8 M. CARTON WEIGHT (LBS): 28,16 M. CARTON SIZE (M): 0,6X0,4X0,2 M. CARTON SIZE (INCH): 23,62X15,75X7,87	



► QUICK DRY FABRIC

**DISCOVER HOODIE MEN DARK TEAL**

ITEM NUMBER	EAN CODE	HS CODE	FEATURES
595219101	S 8718181010771 M 8718181010764 L 8718181010757	61013090	FASHION MEETS FUNCTION DRAWCORD FRONT POCKET
<b>SIZE</b>	XL 8718181010788 2XL 8718181010740	<b>MASTER CARTON INFO</b>	
S   M   L   XL   2XL		QUANTITY PER M. CARTON: 20 M. CARTON WEIGHT (KG): 12,8 M. CARTON WEIGHT (LBS): 28,16 M. CARTON SIZE (M): 0,6X0,4X0,2 M. CARTON SIZE (INCH): 23,62X15,75X7,87	





► THUMB HOLE SLEEVE



► WATERPROOF FABRIC



► PERMANENT TECHNICAL FABRIC



► WINDPROOF FABRIC

### DISCOVER WINDJACKET MEN BLACK

ITEM NUMBER	EAN CODE	HS CODE	FEATURES
595319100	S 8718181010900 M 8718181010894 L 8718181010887 XL 8718181010917 2XL 8718181010870	62011310	FASHION MEETS FUNCTION PERMANENT TECHNICAL FABRIC WINDPROOF FABRIC WATERPROOF FABRIC THUMB HOLE SLEEVE
<b>SIZE</b>		<b>MASTER CARTON INFO</b>	
S   M   L   XL   2XL		QUANTITY PER M. CARTON: 35 M. CARTON WEIGHT (KG): 19,25 M. CARTON WEIGHT (LBS): 42,35 M. CARTON SIZE (M): 0,6X0,4X0,4 M. CARTON SIZE (INCH): 23,62X15,75X15,75	



► THUMB HOLE SLEEVE



► WATERPROOF FABRIC



► PERMANENT TECHNICAL FABRIC



► WINDPROOF FABRIC

**DISCOVER WINDJACKET MEN BORDEAUX RED**

ITEM NUMBER	EAN CODE	HS CODE	FEATURES
595319101	S 8718181010962 M 8718181010955 L 8718181010931 XL 8718181010979 2XL 8718181010924	62011310	FASHION MEETS FUNCTION PERMANENT TECHNICAL FABRIC WINDPROOF FABRIC WATERPROOF FABRIC THUMB HOLE SLEEVE
<b>SIZE</b>		<b>MASTER CARTON INFO</b>	
S   M   L   XL   2XL		QUANTITY PER M. CARTON: 35 M. CARTON WEIGHT (KG): 19,25 M. CARTON WEIGHT (LBS): 42,35 M. CARTON SIZE (M): 0,6X0,4X0,4 M. CARTON SIZE (INCH): 23,62X15,75X15,75	

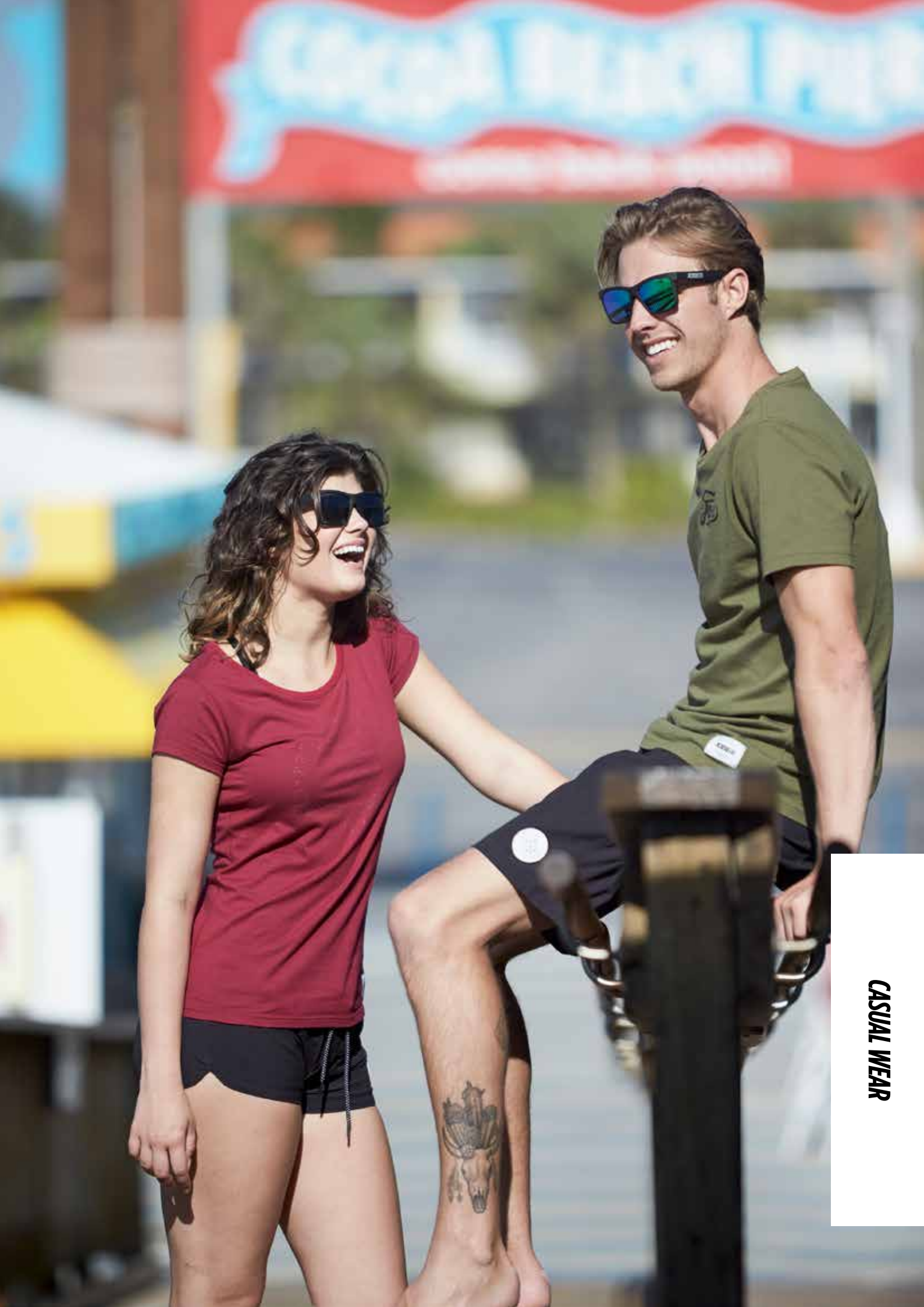

**CASUAL WEAR**



► PREMIUM QUALITY

**CASUAL LOGO T-SHIRT MEN BLACK**

ITEM NUMBER	EAN CODE	HS CODE	FEATURES
565119110	S 8718181009744 M 8718181009737 L 8718181009720	61091000	CASUAL FUNCTIONAL BASIC PREMIUM QUALITY FINE RIB 100% COTTON FABRIC
<b>SIZE</b>	XL 8718181009751 2XL 8718181009713	<b>MASTER CARTON INFO</b>	
S   M   L   XL   2XL		QUANTITY PER M. CARTON: 50 M. CARTON WEIGHT (KG): 9,5 M. CARTON WEIGHT (LBS): 20,9 M. CARTON SIZE (M): 0,4X0,3X0,3 M. CARTON SIZE (INCH): 15,75X11,81X11,81	



► PREMIUM QUALITY

### CASUAL LOGO T-SHIRT MEN WHITE

ITEM NUMBER	EAN CODE	HS CODE	FEATURES
565119111	S 8718181009799 M 8718181009782 L 8718181009775	61091000	CASUAL FUNCTIONAL BASIC PREMIUM QUALITY FINE RIB 100% COTTON FABRIC
<b>SIZE</b>	XL 8718181009805 2XL 8718181009768	<b>MASTER CARTON INFO</b>	
S   M   L   XL   2XL		QUANTITY PER M. CARTON: 50 M. CARTON WEIGHT (KG): 9,5 M. CARTON WEIGHT (LBS): 20,9 M. CARTON SIZE (M): 0,4X0,3X0,3 M. CARTON SIZE (INCH): 15,75X11,81X11,81	



► PREMIUM QUALITY

**CASUAL LOGO T-SHIRT MEN GREY**

ITEM NUMBER	EAN CODE	HS CODE	FEATURES
565119112	S 8718181009843 M 8718181009836 L 8718181009829	61091000	CASUAL FUNCTIONAL BASIC PREMIUM QUALITY FINE RIB 100% COTTON FABRIC
<b>SIZE</b>	XL 8718181009850 2XL 8718181009812	<b>MASTER CARTON INFO</b>	
S   M   L   XL   2XL		QUANTITY PER M. CARTON: 50 M. CARTON WEIGHT (KG): 9,5 M. CARTON WEIGHT (LBS): 20,9 M. CARTON SIZE (M): 0,4X0,3X0,3 M. CARTON SIZE (INCH): 15,75X11,81X11,81	



► PREMIUM QUALITY

### CASUAL T-SHIRT MEN DARK GREY

ITEM NUMBER	EAN CODE	HS CODE	FEATURES
565119100	S 8718181009584 M 8718181009577 L 8718181009560 XL 8718181009607 2XL 8718181009553	61091000	CASUAL FUNCTIONAL BASIC PREMIUM QUALITY FINE RIB 100% COTTON FABRIC
<b>SIZE</b>		<b>MASTER CARTON INFO</b>	
S   M   L   XL   2XL		QUANTITY PER M. CARTON: 50 M. CARTON WEIGHT (KG): 9,5 M. CARTON WEIGHT (LBS): 20,9 M. CARTON SIZE (M): 0,4X0,3X0,3 M. CARTON SIZE (INCH): 15,75X11,81X11,81	



► PREMIUM QUALITY

**CASUAL T-SHIRT MEN ARMY GREEN**

ITEM NUMBER	EAN CODE	HS CODE	FEATURES
565119101	S 8718181009690 M 8718181009683 L 8718181009621 XL 8718181009706 2XL 8718181009614	61091000	CASUAL FUNCTIONAL BASIC PREMIUM QUALITY FINE RIB 100% COTTON FABRIC
<b>SIZE</b>		<b>MASTER CARTON INFO</b>	
S   M   L   XL   2XL		QUANTITY PER M. CARTON: 50 M. CARTON WEIGHT (KG): 9,5 M. CARTON WEIGHT (LBS): 20,9 M. CARTON SIZE (M): 0,4X0,3X0,3 M. CARTON SIZE (INCH): 15,75X11,81X11,81	







► PREMIUM QUALITY



► 100% COTTON FABRIC

**CASUAL T-SHIRT WOMEN**

ITEM NUMBER	EAN CODE	HS CODE	FEATURES
565119200	XS 8718181009904 S 8718181009881 M 8718181009874 L 8718181009867 XL 8718181009898	61091000	CASUAL FUNCTIONAL BASIC PREMIUM QUALITY FINE RIB 100% COTTON FABRIC
<b>SIZE</b>		<b>MASTER CARTON INFO</b>	
XS   S   M   L   XL		QUANTITY PER M. CARTON: 50 M. CARTON WEIGHT (KG): 9,5 M. CARTON WEIGHT (LBS): 20,9 M. CARTON SIZE (M): 0,4X0,3X0,3 M. CARTON SIZE (INCH): 15,75X11,81X11,81	

**PONCHO**

<b>ITEM NUMBER</b>	<b>EAN CODE</b>	<b>HS CODE</b>	<b>FEATURES</b>
560018001	PCS 8718181263214	62011310	SOFT FABRIC KEEPS YOU WARM TOWEL FOR CHANGING
<b>SIZE</b>	<b>MASTER CARTON INFO</b>		
PCS.	QUANTITY PER M. CARTON: 20 M. CARTON WEIGHT (KG): 14,4 M. CARTON WEIGHT (LBS): 31,68 M. CARTON SIZE (M): 0,6X0,4X0,4 M. CARTON SIZE (INCH): 23,62X15,75X15,75		





## BACKPACK

ITEM NUMBER	EAN CODE	HS CODE	FEATURES
224319001	PCS. 8718181013826	42029291	300D NYLON BACKPACK 45X30X20 CM PADDED SHOULDER STRAPS LAPTOP COMPARTMENT
SIZE	MASTER CARTON INFO		
PCS.	QUANTITY PER M. CARTON:	20	
	M. CARTON WEIGHT (KG):	0,2	
	M. CARTON WEIGHT (LBS):	0,44	
	M. CARTON SIZE (M):	0,49X0,47X0,52	
	M. CARTON SIZE (INCH):	19,29X18,5X20,47	



**JOBE BEAM FLOATABLE GLASSES BLACK-GREEN**

ITEM NUMBER	EAN CODE	HS CODE	FEATURES
426018003	PCS. 8718181000413	90041091	FLOATABLE SUNGLASSES POLARIZED GLASSES COMFORTABLE DESIGN NON SLIP NOSE HOLDER INCLUDING SUNGLASS SOFT BAG UV 400
SIZE	MASTER CARTON INFO		
PCS.		QUANTITY PER M. CARTON: 100 M. CARTON WEIGHT (KG): 11 M. CARTON WEIGHT (LBS): 24,2 M. CARTON SIZE (M): 0,34X0,34X0,49 M. CARTON SIZE (INCH): 13,39X13,19X19,29	



**JOBE BEAM FLOATABLE GLASSES BLACK-SMOKE**

ITEM NUMBER	EAN CODE	HS CODE	FEATURES
426018004	PCS. 8718181000420	90041091	FLOATABLE SUNGLASSES POLARIZED GLASSES COMFORTABLE DESIGN NON SLIP NOSE HOLDER INCLUDING SUNGLASS SOFT BAG UV 400
<b>SIZE</b>	<b>MASTER CARTON INFO</b>		
PCS.	QUANTITY PER M. CARTON: 100 M. CARTON WEIGHT (KG): 11 M. CARTON WEIGHT (LBS): 24,2 M. CARTON SIZE (M): 0,34X0,34X0,49 M. CARTON SIZE (INCH): 13,39 X13,19 X19,29		



**JOBE DIM FLOATABLE GLASSES BLACK-SMOKE**

ITEM NUMBER	EAN CODE	HS CODE	FEATURES
426018002	PCS. 8718181000390	90041091	FLOATABLE SUNGLASSES POLARIZED GLASSES COMFORTABLE DESIGN NON SLIP NOSE HOLDER INCLUDING SUNGLASS SOFT BAG UV 400
SIZE	<b>MASTER CARTON INFO</b>		
PCS.	QUANTITY PER M. CARTON: 100 M. CARTON WEIGHT (KG): 11 M. CARTON WEIGHT (LBS): 24,2 M. CARTON SIZE (M): 0,34X0,34X0,49 M. CARTON SIZE (INCH): 13,39X13,19X19,29		





**JOBE DIM FLOATABLE GLASSES TORTOISE-SMOKE**

ITEM NUMBER	EAN CODE	HS CODE	FEATURES
426018005	PCS. 8718181000437	90041091	FLOATABLE SUNGLASSES POLARIZED GLASSES COMFORTABLE DESIGN NON SLIP NOSE HOLDER INCLUDING SUNGLASS SOFT BAG UV 400
<b>SIZE</b>	<b>MASTER CARTON INFO</b>		
PCS.	QUANTITY PER M. CARTON: 100 M. CARTON WEIGHT (KG): 11 M. CARTON WEIGHT (LBS): 24,2 M. CARTON SIZE (M): 0,34 X 0,34 X 0,49 M. CARTON SIZE (INCH): 13,39 X 13,19 X 19,29		



**JOBE DIM FLOATABLE GLASSES BLACK-GREEN**

<i>ITEM NUMBER</i>	<i>EAN CODE</i>	<i>HS CODE</i>	<i>FEATURES</i>
426018001	PCS. 8718181000383	90041091	FLOATABLE SUNGLASSES POLARIZED GLASSES COMFORTABLE DESIGN NON SLIP NOSE HOLDER INCLUDING SUNGLASS SOFT BAG UV 400
<i>SIZE</i>	<i>MASTER CARTON INFO</i>		
PCS.	<i>QUANTITY PER M. CARTON:</i> 100 <i>M. CARTON WEIGHT (KG):</i> 11 <i>M. CARTON WEIGHT (LBS):</i> 24,2 <i>M. CARTON SIZE (M):</i> 0,34X0,34X0,49 <i>M. CARTON SIZE (INCH):</i> 13,39 X13,19 X19,29		



**GLOVES**

# SIZING GLOVES

## GLOVES

SIZE	HAND (CM)	HAND (INCH)
XS	15-18	5,9-7,1
S	18-20	7,1-7,9
M	20-23	7,9-9,1
L	23-25,5	9,1-10
XL	25,5-28	10-11
2XL	28-30,5	11-12



WE ARE CONSTANTLY WORKING ON THE SIZING OF OUR PRODUCTS. CHECK OUT [JOBESPORTS.COM](https://www.jobesports.com) FOR THE MOST UP TO DATE, IMPROVED SIZING! ALL MEASUREMENTS ARE FOR REFERENCE ONLY.





### STREAM GLOVES MEN

ITEM NUMBER	EAN CODE	HS CODE	FEATURES
341017002	S 8718181230803 M 8718181230797 L 8718181230780	62160000	SOFT SUEDE FABRIC AT THE PALMS KNUCKLE PROTECTION ADJUSTABLE VELCRO WRIST STRAP PRE-CURVED SHAPE FOR OPTIMAL COMFORT
<b>SIZE</b>	XL 8718181230810 2XL 8718181230827	<b>MASTER CARTON INFO</b>	
S   M   L   XL   2XL		QUANTITY PER M. CARTON: 40 M. CARTON WEIGHT (KG): 6,4 M. CARTON WEIGHT (LBS): 14,08 M. CARTON SIZE (M): 0,48X0,36X0,28 M. CARTON SIZE (INCH): 18,9X14,17X11,02	



**GRIP GLOVES MEN**

ITEM NUMBER	EAN CODE	HS CODE	FEATURES
341017003	XS 8718181230926 S 8718181230902 M 8718181230896	62160000	CUT OFF OPTION: FULL FINGER TO 3/4 DESIGN STRONG RALVEC FABRIC FOR OPTIMAL GRIP KNUCKLE PROTECTION ADJUSTABLE VELCRO WRIST & HAND STRAP PRE-CURVED SHAPE FOR OPTIMAL COMFORT
<b>SIZE</b>	L 8718181230889 XL 8718181230919 2XL 8718181230933	<b>MASTER CARTON INFO</b>	
XS   S   M   L   XL   2XL		QUANTITY PER M. CARTON: 40 M. CARTON WEIGHT (KG): 7,6 M. CARTON WEIGHT (LBS): 16,72 M. CARTON SIZE (M): 0,48X0,36X0,28 M. CARTON SIZE (INCH): 18,9X14,17X11,02	



**GRIP GLOVES WOMEN**

ITEM NUMBER	EAN CODE	HS CODE	FEATURES
341117003	XS 8718181228237 S 8718181228213 M 8718181228206	62160000	CUT OFF OPTION: FULL FINGER TO 3/4 DESIGN STRONG RALVEC FABRIC FOR OPTIMAL GRIP KNUCKLE PROTECTION
<b>SIZE</b>	L 8718181228190 XL 8718181228220	<b>MASTER CARTON INFO</b>	ADJUSTABLE VELCRO WRIST & HAND STRAP PRE-CURVED SHAPE FOR OPTIMAL COMFORT
XS   S   M   L   XL		QUANTITY PER M. CARTON: 40 M. CARTON WEIGHT (KG): 6 M. CARTON WEIGHT (LBS): 13,2 M. CARTON SIZE (M): 0,48X0,36X0,28 M. CARTON SIZE (INCH): 18,9X14,17X11,02	







**NEOPRENE GLOVES**

ITEM NUMBER	EAN CODE	HS CODE	FEATURES
340019002	S 8718181006842 M 8718181006835 L 8718181006828	61161020	3 MM NEOPRENE THICKNESS FULL STRETCH NEOPRENE GLUED & BLIND STITCHED SEAMS: NO WATER ENTRY THROUGH SEAMS
<b>SIZE</b>	XL 8718181006859 2XL 8718181006811	<b>MASTER CARTON INFO</b>	PRE-CURVED SHAPE FOR OPTIMAL COMFORT NON-SLIP PRINT ON THE PALMS
S   M   L   XL   2XL		QUANTITY PER M. CARTON: 50 M. CARTON WEIGHT (KG): 6,5 M. CARTON WEIGHT (LBS): 14,3 M. CARTON SIZE (M): 0,61X0,34X0,33 M. CARTON SIZE (INCH): 24X13,5X13	



**PALM PROTECTORS**

ITEM NUMBER	EAN CODE	HS CODE	FEATURES
340017002	PCS. 8718181237437	95062900	FULL STRETCH NEOPRENE
<b>SIZE</b>		<b>MASTER CARTON INFO</b>	
PCS.		QUANTITY PER M. CARTON: 40	
		M. CARTON WEIGHT (KG): 2	
		M. CARTON WEIGHT (LBS): 4,4	
		M. CARTON SIZE (M): 0,48X0,36X0,42	
		M. CARTON SIZE (INCH): 18,9X14,17X16,54	

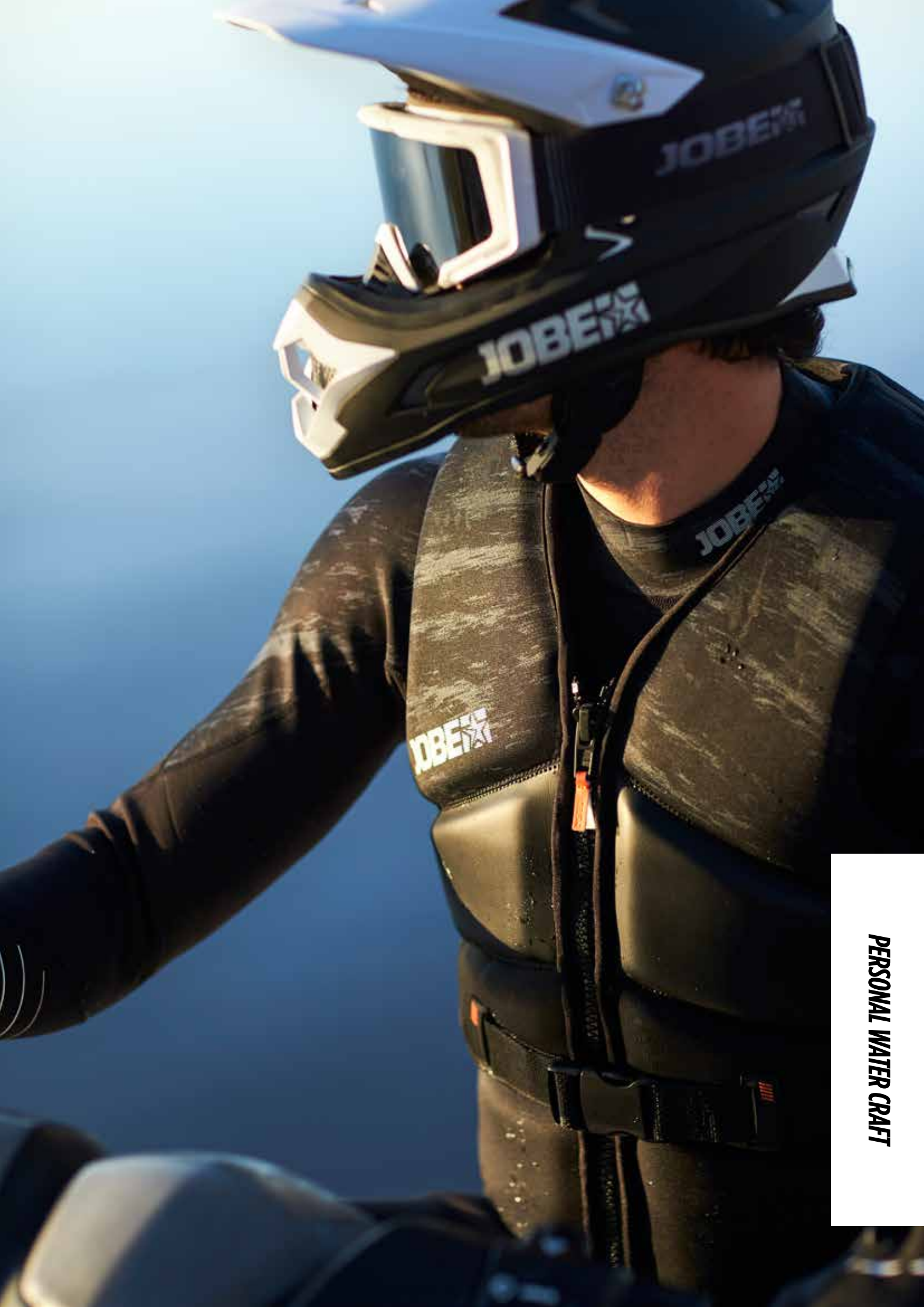

**PERSONAL WATER CRAFT**

# SIZING PWC

## MEN VESTS

SIZE	UNIFY, SEGMENTED, BACKSUPPORT, NEOPRENE & SIDE ENTRY VEST (CERTIFIED SON) (ATHLETIC FIT)				(+ SIZES LEISURE FIT)			
	CHEST (CM)	CHEST (INCH)	WAIST (CM)	WAIST (INCH)	CHEST (CM)	CHEST (INCH)	WAIST (CM)	WAIST (INCH)
<b>XS</b>	90-94	35,4-37	80-84	31,5-33,1	-	-	-	-
<b>S</b>	94-98	37-38,6	84-88	33,1-34,7	-	-	-	-
<b>M</b>	98-102	38,6-40,2	88-92	34,7-36,2	-	-	-	-
<b>L</b>	102-106	40,2-41,7	92-96	36,2-37,8	-	-	-	-
<b>XL</b>	106-110	41,7-43,3	96-100	37,8-39,4	-	-	-	-
<b>XL+</b>	-	-	-	-	106-112	41,7-44,1	96-104	37,8-40,9
<b>2XL+</b>	-	-	-	-	112-118	44,1-46,5	104-112	40,9-44,1
<b>3XL+</b>	-	-	-	-	118-124	46,5-48,8	112-120	44,1-47,2
<b>4XL+</b>	-	-	-	-	124-130	48,8-51,2	120-128	47,2-50,4
<b>5XL+</b>	-	-	-	-	130-136	51,2-53,5	128-136	50,4-53,5

## UNISEX VESTS

	DUAL VEST (CERTIFIED SON)			
	CHEST (CM)	CHEST (INCH)	WAIST (CM)	WAIST (INCH)
S/M	94-102	37-40,2	84-92	33,1-36,2
L/XL	102-110	40,2-43,3	92-100	36,2-39,4
2XL/3XL	110-118	43,3-46,5	100-108	39,4-42,5
4XL/5XL	118-128	46,5-50,4	108-118	42,5-46,5

## HELMETS

	DETROIT (CM)	DETROIT (INCH)
S	56	22
M	58	22,8
L	60	23,6

## MEN WETSUITS

SIZE	CHEST (CM)	CHEST (INCH)	WAIST (CM)	WAIST (INCH)	HIP (CM)	HIP (INCH)	LENGTH (CM)	LENGTH (INCH)
<b>XS</b>	90-94	35,4-37	80-84	31,5-33,1	90-94	35,4-37	173-179	68,1-70,5
<b>S</b>	94-98	37-38,6	84-88	33,1-34,6	94-98	37-38,6	175-181	68,9-71,3
<b>M</b>	98-102	38,6-40,2	88-92	34,6-36,2	98-102	38,6-40,2	177-183	69,7-72
<b>MT</b>	98-102	38,6-40,2	88-92	34,6-36,2	98-102	38,6-40,2	179-185	70,5-72,8
<b>L</b>	102-106	40,2-41,7	92-96	36,2-37,8	102-106	40,2-41,7	179-185	70,5-72,8
<b>LT</b>	102-106	40,2-41,7	92-96	36,2-37,8	102-106	40,2-41,7	181-187	71,3-73,6
<b>XL</b>	106-110	41,7-43,3	96-100	37,8-39,4	106-110	41,7-43,3	181-187	71,3-73,6
<b>2XL</b>	111-117	43,7-46,1	101-107	39,8-42,1	111-117	43,7-46,1	183-189	72-74,4
<b>3XL</b>	117-123	46,1-48,4	107-113	42,1-44,5	117-123	46,1-48,4	185-191	72,8-75,2
<b>4XL</b>	123-129	48,4-50,8	113-119	44,5-46,9	123-129	48,4-50,8	187-193	73,6-76

## GLOVES

SIZE	HAND (CM)	HAND (INCH)
<b>XS</b>	15-18	5,9-7,1
<b>S</b>	18-20	7,1-7,9
<b>M</b>	20-23	7,9-9,1
<b>L</b>	23-25,5	9,1-10
<b>XL</b>	25,5-28	10-11
<b>2XL</b>	28-30,5	11-12



## WOMEN VESTS

SIZE	NEOPRENE VEST (CERTIFIED SON)			
	CHEST (CM)	CHEST (INCH)	WAIST (CM)	WAIST (INCH)
<b>XS</b>	82-86	32,3-33,9	65-69	25,6-27,2
<b>S</b>	86-90	33,9-35,4	70-74	27,6-29,1
<b>S+</b>	90-94	35,4-37	74-78	29,1-30,7
<b>M</b>	94-98	37-38,6	78-82	30,7-32,3
<b>M+</b>	98-102	38,6-40,2	83-87	32,7-34,3
<b>L</b>	102-106	40,2-41,7	87-92	34,3-36,2
<b>XL</b>	107-113	42,1-44,5	93-99	36,6-39
<b>2XL</b>	113-119	44,5-46,9	99-105	39-41,3
<b>3XL</b>	119-125	46,9-49,2	106-112	41,7-44,1



## WOMEN WETSUITS

SIZE	CHEST (CM)	CHEST (INCH)	WAIST (CM)	WAIST (INCH)	HIP (CM)	HIP (INCH)	LENGTH (CM)	LENGTH (INCH)
<b>XS</b>	84-88	33,1-34,6	68-72	26,8-28,3	90-94	35,4-37	165-171	65-67,3
<b>S</b>	88-92	34,6-36,2	72-76	28,3-29,9	94-98	37-38,6	167-173	65,7-68,1
<b>M</b>	93-99	36,6-39	77-83	30,3-32,7	99-105	39-41,3	169-175	66,5-68,9
<b>L</b>	99-105	39-41,3	83-89	32,7-35	105-111	41,3-43,7	171-177	67,3-69,7
<b>XL</b>	105-111	41,3-43,7	89-95	35-37,4	111-117	43,7-46,1	173-179	68,1-70,5
<b>2XL</b>	111-117	43,7-46,1	95-101	37,4-39,8	117-123	46,1-48,4	175-181	68,9-71,3

WE ARE CONSTANTLY WORKING ON THE SIZING OF OUR PRODUCTS. CHECK OUT [JOBSSPORTS.COM](https://www.jobssports.com) FOR THE MOST UP TO DATE, IMPROVED SIZING! ALL MEASUREMENTS ARE FOR REFERENCE ONLY.



► STRONG & LIGHTWEIGHT NYLON FABRIC



► STRONG YKK BUCKLES



► 50N ISO-CERTIFIED (BUOYANCY AID)

### DUAL JET VEST

**ITEM NUMBER**

244819510

**EAN CODE**

S/M 8718181001069  
 L/XL 8718181001076  
 2XL/3XL 8718181001090  
 4XL/5XL 8718181001083

**HS CODE**

63072000

**FEATURES**

50N ISO-CERTIFIED (BUOYANCY AID)  
 LIGHTWEIGHT PE-FOAM  
 STRONG & LIGHTWEIGHT NYLON FABRIC  
 1" ADJUSTABLE WEBBING STRAPS (4X)  
 STRONG YKK BUCKLES  
 ALWAYS A PERFECT FIT: MORE COMFORT AND SAFETY  
 SAFETY D-RING ATTACHMENT FOR AN EMERGENCY CORD  
 WATER DRAINAGE SYSTEM  
 ADJUSTABLE SIZING DUE TO NYLON SIDES  
 UNISEX FIT

**SIZE**

S/M | L/XL | 2XL/3XL | 4XL/5XL

**MASTER CARTON INFO**

QUANTITY PER M. CARTON: 10  
 M. CARTON WEIGHT (KG): 5,7  
 M. CARTON WEIGHT (LBS): 12,54  
 M. CARTON SIZE (M): 0,8X0,6X0,45  
 M. CARTON SIZE (INCH): 31,5X23,62X17,72



► STRONG YKK ZIPPER



► 50N ISO-CERTIFIED (BUOYANCY AID)



► SOFT PVC FOAM

**NEOPRENE JET VEST WOMEN**

ITEM NUMBER	EAN CODE	HS CODE	FEATURES
244919222	XS 8718181002875 S 8718181002844 S+ 8718181002851	63072000	50N ISO-CERTIFIED (BUOYANCY AID) SOFT PVC FOAM FRONT ZIPPER FOR FAST ENTRY
<b>SIZE</b>	M 8718181002820 M+ 8718181002837 L 8718181002813 XL 8718181002868 2XL 8718181002790 3XL 8718181002806	<b>MASTER CARTON INFO</b>	SOFT & FLEXIBLE NEOPRENE FABRIC 1,5" ADJUSTABLE WEBBING STRAPS (2X) STRONG YKK BUCKLES STRONG YKK ZIPPER
XS   S   S+   M   M+   L   XL   2XL   3XL		QUANTITY PER M. CARTON: 10 M. CARTON WEIGHT (KG): 11,4 M. CARTON WEIGHT (LBS): 25,08 M. CARTON SIZE (M): 0,8X0,6X0,45 M. CARTON SIZE (INCH): 31,5X23,62X17,72	ALWAYS A PERFECT FIT: MORE COMFORT AND SAFETY SAFETY D-RING FOR ATTACHMENT EMERGENCY CORD WATER DRAINAGE SYSTEM



► STRONG YKK ZIPPER



► STRONG YKK BUCKLES



► 50N ISO-CERTIFIED (BUOYANCY AID)



► SOFT PVC FOAM

## NEOPRENE JET VEST MEN

ITEM NUMBER	EAN CODE	HS CODE	FEATURES
244919130	XS 8718181002172 S 8718181002141 M 8718181002134 L 8718181002127 XL 8718181002158	63072000	50N ISO-CERTIFIED (BUOYANCY AID) SOFT PVC FOAM FRONT ZIPPER FOR FAST ENTRY SOFT & FLEXIBLE NEOPRENE FABRIC 1,5" ADJUSTABLE WEBBING STRAPS (2X)
<b>SIZE</b>	XL+ 8718181002165 2XL+ 8718181002097 3XL+ 8718181002103 4XL+ 8718181002110	<b>MASTER CARTON INFO</b>	STRONG YKK BUCKLES STRONG YKK ZIPPER ALWAYS A PERFECT FIT: MORE COMFORT AND SAFETY SAFETY D-RING FOR ATTACHMENT EMERGENCY CORD WATER DRAINAGE SYSTEM
XS   S   M   L   XL   XL+   2XL+   3XL+   4XL+		QUANTITY PER M. CARTON: 10 M. CARTON WEIGHT (KG): 14,1 M. CARTON WEIGHT (LBS): 31,02 M. CARTON SIZE (M): 0,8X0,6X0,45 M. CARTON SIZE (INCH): 31,5 X 23,62 X 17,72	



► STRONG YKK ZIPPER



► STRONG YKK BUCKLES



► BACK SUPPORT PROTECTOR

**SEGMENTED JET VEST BACKSUPPORT MEN**

ITEM NUMBER	EAN CODE	HS CODE	FEATURES
244919120	S 8718181001915 M 8718181001908 L 8718181001892	63072000	50N ISO-CERTIFIED (BUOYANCY AID)   SOFT PVC FOAM FRONT ZIPPER FOR FAST ENTRY   BACK SUPPORT PROTECTOR SOFT & FLEXIBLE NEOPRENE FABRIC ADJUSTABLE NEOPRENE WAIST BELT SUPPORT LOW HORIZONTAL FOAM SEGMENT TO SUPPORT SITTING POSTURE   1,5" ADJUSTABLE WEBBING STRAPS (2X) INTEGRATED WEBBING FOR A CLEAN LOOK STRONG YKK BUCKLES   STRONG YKK ZIPPER ALWAYS A PERFECT FIT: MORE COMFORT AND SAFETY SPLIT FOAM PANELS FOR MAXIMUM FREEDOM OF MOVEMENT SAFETY D-RING FOR ATTACHMENT EMERGENCY CORD WATER DRAINAGE SYSTEM
<b>SIZE</b>	XL 8718181001922 XL+ 8718181001946	<b>MASTER CARTON INFO</b>	
S   M   L   XL   XL+   2XL+   3XL+	2XL+ 8718181001878 3XL+ 8718181001885	QUANTITY PER M. CARTON: 10 M. CARTON WEIGHT (KG): 17,8 M. CARTON WEIGHT (LBS): 39,16 M. CARTON SIZE (M): 0,8X0,6X0,5 M. CARTON SIZE (INCH): 31,5X23,62X19,69	





► STRONG YKK BUCKLES



► SOFT & FLEXIBLE NEOPRENE FABRIC

### SIDE ENTRY JET VEST MEN

ITEM NUMBER	EAN CODE	HS CODE	FEATURES
244919140	S 8718181002226 M 8718181002219 L 8718181002202 XL 8718181002233 XL+ 8718181002240 2XL+ 8718181002189 3XL+ 8718181002196	63072000	50N ISO-CERTIFIED (BUOYANCY AID) SOFT PVC FOAM SIDE ZIPPER FOR FAST ENTRY & CHEST PROTECTION SOFT & FLEXIBLE NEOPRENE FABRIC 1,5" ADJUSTABLE WEBBING STRAPS (2X) INTEGRATED WEBBING FOR A CLEAN LOOK STRONG YKK BUCKLES   STRONG YKK ZIPPER ALWAYS A PERFECT FIT: MORE COMFORT AND SAFETY SAFETY D-RING FOR ATTACHMENT EMERGENCY CORD WATER DRAINAGE SYSTEM LOW HORIZONTAL FOAM SEGMENT TO SUPPORT SITTING POSTURE
<b>SIZE</b> S   M   L   XL   XL+   2XL+   3XL+		<b>MASTER CARTON INFO</b> QUANTITY PER M. CARTON: 10 M. CARTON WEIGHT (KG): 14,7 M. CARTON WEIGHT (LBS): 32,34 M. CARTON SIZE (M): 0,7 X 0,53 X 0,53 M. CARTON SIZE (INCH): 27,5 X 21 X 21	



▶ ADJUSTABLE NEOPRENE WAIST BELT SUPPORT



▶ SIDE ZIPPER



▶ BACK SUPPORT PROTECTOR

**MOLDED JET VEST MEN**

ITEM NUMBER	EAN CODE	HS CODE	FEATURES
245017001	S/M L/XL	8718181240314 8718181240307	63072000
<b>SIZE</b>	S/M   L/XL	<b>MASTER CARTON INFO</b>	
		QUANTITY PER M. CARTON:	10
		M. CARTON WEIGHT (KG):	12,00
		M. CARTON WEIGHT (LBS):	26,46
		M. CARTON SIZE (M):	0,59 X 0,51 X 0,64
		M. CARTON SIZE (INCH):	23,23 X 20,08 X 25,2
		50N ISO-CERTIFIED (BUOYANCY AID) SIDE ZIPPER FOR FAST ENTRY & CHEST PROTECTION MOLDED NEOPRENE & EVA FOAM FOR A TOUGH LOOK 1,5" ADJUSTABLE WEBBING STRAPS (2X) INTEGRATED WEBBING FOR A CLEAN LOOK STRONG YKK BUCKLES STRONG YKK ZIPPER BACK SUPPORT PROTECTOR ADJUSTABLE NEOPRENE WAIST BELT SUPPORT SAFETY D-RING FOR ATTACHMENT EMERGENCY CORD WATER DRAINAGE SYSTEM	



► 2 MM NEOPRENE



► FEMININE FIT



► BREATHABLE BACK KNEES

**PORTO JET LONG JOHN 2MM**

ITEM NUMBER	EAN CODE	HS CODE	FEATURES
303819210	XS 8718181006217 S 8718181006194 M 8718181006187 L 8718181006170 XL 8718181006200	61130010	2 MM NEOPRENE THICKNESS FULL STRETCH NEOPRENE SOFT, FLEXIBLE & BREATHABLE STITCHED SEAMS VELCRO SHOULDER ENTRY BREATHABLE BACK KNEES PROTECTIVE STRONG KNEE PADS FEMININE FIT LARGE ARMHOLES FOR MAXIMUM FREEDOM OF MOVEMENT
<b>SIZE</b>		<b>MASTER CARTON INFO</b>	
XS   S   M   L   XL		QUANTITY PER M. CARTON: 10 M. CARTON WEIGHT (KG): 6,1 M. CARTON WEIGHT (LBS): 13,42 M. CARTON SIZE (M): 0,99X0,53X0,11 M. CARTON SIZE (INCH): 39X21X4,5	



► 2 MM NEOPRENE



► SOFT, FLEXIBLE & BREATHABLE STITCHED SEAMS



► FEMININE FIT

**PORTO JET JACKET 2MM**

ITEM NUMBER	EAN CODE	HS CODE	FEATURES
303819211	XS 8718181006262 S 8718181006248 M 8718181006231	61130010	2 MM NEOPRENE THICKNESS FULL STRETCH NEOPRENE SOFT, FLEXIBLE & BREATHABLE STITCHED SEAMS FRONT ZIPPER FOR FAST ENTRY FEMININE FIT
<b>SIZE</b>	L 8718181006224 XL 8718181006255	<b>MASTER CARTON INFO</b>	
XS   S   M   L   XL		QUANTITY PER M. CARTON: 10 M. CARTON WEIGHT (KG): 4,8 M. CARTON WEIGHT (LBS): 10,56 M. CARTON SIZE (M): 1,3X0,74X0,15 M. CARTON SIZE (INCH): 51X29X6	



► 2 MM NEOPRENE



► D3O SHIN & KNEE PROTECTION



► LARGE ARMHOLES FOR MAXIMUM FREEDOM OF MOVEMENT

**TORONTO JET LONG JOHN 2MM SHINPROTECTOR**

ITEM NUMBER	EAN CODE	HS CODE	FEATURES
303819110	S 8718181005876 M 8718181005869 L 8718181005852	61130010	2 MM NEOPRENE THICKNESS FULL STRETCH NEOPRENE SOFT, FLEXIBLE & BREATHABLE STITCHED SEAMS STRENGTHENING TAPE INSIDE VELCRO SHOULDER ENTRY BREATHABLE BACK KNEES
<b>SIZE</b>	XL 8718181005883 2XL 8718181005838 3XL 8718181005845	<b>MASTER CARTON INFO</b>	D3O SHIN & KNEE PROTECTION (WWW.D3O.COM) LARGE ARMHOLES FOR MAXIMUM FREEDOM OF MOVEMENT
S   M   L   XL   2XL   3XL		QUANTITY PER M. CARTON: 10 M. CARTON WEIGHT (KG): 7,2 M. CARTON WEIGHT (LBS): 15,84 M. CARTON SIZE (M): 0,99X0,53X0,11 M. CARTON SIZE (INCH): 39X21X4,5	



**MIX  
AND  
MATCH**





JOBET

JOBET

FL 8077 RN

RUNNER



► 2 MM NEOPRENE



► FULL STRETCH NEOPRENE



► SOFT, FLEXIBLE & BREATHABLE STITCHED SEAMS

**TORONTO JET JACKET 2MM SIDEZIP**

ITEM NUMBER	EAN CODE	HS CODE	FEATURES
303819111	S 8718181005937 M 8718181005920 L 8718181005913	61130010	2 MM NEOPRENE THICKNESS FULL STRETCH NEOPRENE SOFT, FLEXIBLE & BREATHABLE STITCHED SEAMS SIDE ZIPPER FOR FAST ENTRY
<b>SIZE</b>	XL 8718181005944 2XL 8718181005890 3XL 8718181005906	<b>MASTER CARTON INFO</b>	
S   M   L   XL   2XL   3XL		QUANTITY PER M. CARTON: 10 M. CARTON WEIGHT (KG): 6,1 M. CARTON WEIGHT (LBS): 13,42 M. CARTON SIZE (M): 1,3X0,74X0,15 M. CARTON SIZE (INCH): 51X29X6	





► 2 MM NEOPRENE



► VELCRO SHOULDER ENTRY



► BREATHABLE BACK KNEES

**TORONTO JET LONG JOHN 2MM**

ITEM NUMBER	EAN CODE	HS CODE	FEATURES
303819112	S 8718181005999 M 8718181005982 L 8718181005975	61130010	2 MM NEOPRENE THICKNESS FULL STRETCH NEOPRENE SOFT, FLEXIBLE & BREATHABLE STITCHED SEAMS VELCRO SHOULDER ENTRY BREATHABLE BACK KNEES PROTECTIVE STRONG KNEE PADS LARGE ARMHOLES FOR MAXIMUM FREEDOM OF MOVEMENT
<b>SIZE</b>	XL 8718181006002 2XL 8718181005951 3XL 8718181005968	<b>MASTER CARTON INFO</b>	
S   M   L   XL   2XL   3XL		QUANTITY PER M. CARTON: 10 M. CARTON WEIGHT (KG): 7,2 M. CARTON WEIGHT (LBS): 15,84 M. CARTON SIZE (M): 0,99X0,53X0,11 M. CARTON SIZE (INCH): 39X21X4,5	



► 2 MM NEOPRENE



► SOFT, FLEXIBLE & BREATHABLE STITCHED SEAMS



► FRONT ZIPPER

**TORONTO JET JACKET FRONTZIP 2MM**

ITEM NUMBER	EAN CODE	HS CODE	FEATURES
303819113	S 8718181006057 M 8718181006040 L 8718181006033	61130010	2 MM NEOPRENE THICKNESS FULL STRETCH NEOPRENE SOFT, FLEXIBLE & BREATHABLE STITCHED SEAMS FRONT ZIPPER FOR FAST ENTRY
<b>SIZE</b>	XL 8718181006064 2XL 8718181006019 3XL 8718181006026	<b>MASTER CARTON INFO</b>	
S   M   L   XL   2XL   3XL		QUANTITY PER M. CARTON: 10 M. CARTON WEIGHT (KG): 6,1 M. CARTON WEIGHT (LBS): 13,42 M. CARTON SIZE (M): 1,3X0,74X0,15 M. CARTON SIZE (INCH): 51X29X6	



► 3/2MM NEOPRENE

► BACK ZIPPER

► D3O IMPACT PROTECTORS

**DETROIT JET FULLSUIT PRE-SHAPED ARMOR 3/2MM**

ITEM NUMBER	EAN CODE	HS CODE	FEATURES
303518152	S 8718181246415 M 8718181246408 L 8718181246392 XL 8718181246422 2XL 8718181246439	61130010	3MM NEOPRENE ON CHEST & BACK, 2MM ON OTHER PANELS PRE-CURVED JETSKI STANCE SHAPE FOR OPTIMAL COMFORT D3O IMPACT PROTECTORS ON SHINS, KNEES, ELBOWS & SHOULDERS (WWW.D3O.COM) SOFT, FLEXIBLE & BREATHABLE STITCHED SEAMS STRENGTHENING TAPE INSIDE BACK ZIPPER FOR FAST ENTRY WATER DRAINAGE SYSTEM
<b>SIZE</b>		<b>MASTER CARTON INFO</b>	
S   M   L   XL   2XL		QUANTITY PER M. CARTON: 5 M. CARTON WEIGHT (KG): 6,875 M. CARTON WEIGHT (LBS): 15,125 M. CARTON SIZE (M): 1,52X0,53X0,11 M. CARTON SIZE (INCH): 60X21X4,5	



**DRYSUIT**

ITEM NUMBER	EAN CODE	HS CODE	FEATURES
303719001	XS 8718181005708 S 8718181005685 M 8718181005678	61130010	320 DENIER BREATHABLE NYLON FABRIC WATER REPELLENT TRICOT COATED FABRIC WATERPROOF TAPED SEAMS
<b>SIZE</b>	L 8718181005661 XL 8718181005692 2XL 8718181005654	<b>MASTER CARTON INFO</b>	LATEX NECK, WRISTS AND ANKLES TO BLOCK WATER ENTRY WATERPROOF ZIPPER AT THE BACK ADJUSTABLE VELCRO WRISTS & ANKLES
XS   S   M   L   XL   2XL		QUANTITY PER M. CARTON: 10 M. CARTON WEIGHT (KG): 17,7 M. CARTON WEIGHT (LBS): 38,94 M. CARTON SIZE (M): 1,02 X 0,56 X 0,18 M. CARTON SIZE (INCH): 40 X 22 X 7	





**NEOPRENE BOOTS BLACK**

ITEM NUMBER	EAN CODE	HS CODE	FEATURES
534715003	5 8718181173261	64041990	PWC DESIGNED BOOT NEOPRENE INNER SOCK REINFORCED HEEL FOR EXTRA SUPPORT STIFF RUBBER OUTSOLE FOR A MAXIMUM GRIP EXTRA WATER DRAINS QUICK-DRYING MATERIALS
	6 8718181173278		
	7 8718181173285		
<b>SIZE</b>	8 8718181173292	<b>MASTER CARTON INFO</b>	
	9 8718181173308	QUANTITY PER M. CARTON: 20	
5   6   7   8   9   10   11   12	10 8718181173223	M. CARTON WEIGHT (KG): 13,8	
	11 8718181173230	M. CARTON WEIGHT (LBS): 30,36	
	12 8718181173247	M. CARTON SIZE (M): 0,71X0,55X0,43	
		M. CARTON SIZE (INCH): 28,07X21,5X16,97	



### WATERPROOF GADGET BAG

ITEM NUMBER	EAN CODE	HS CODE	FEATURES
420016001	PCS. 8718181199957	42029291	WATERPROOF FLOATABLE NECK LEASH ATTACHMENT HOOK MAKE CALLS, PHOTOS & VIDEOS
SIZE	MASTER CARTON INFO		
PCS.	QUANTITY PER M. CARTON:	150	
	M. CARTON WEIGHT (KG):	10,5	
	M. CARTON WEIGHT (LBS):	23,1	
	M. CARTON SIZE (M):	0,6X0,35X0,3	
	M. CARTON SIZE (INCH):	23,62X13,78X11,81	



**SUCTION GLOVES MEN**

ITEM NUMBER	EAN CODE	HS CODE	FEATURES
340019001	XS 8718181006804 S 8718181006781 M 8718181006774	62160000	NON-SLIP AMARA FABRIC PALMS FOR OPTIMAL GRIP KNUCKLE PROTECTION ADJUSTABLE VELCRO WRIST STRAP PRE-CURVED SHAPE FOR OPTIMAL COMFORT
<b>SIZE</b>	L 8718181006767 XL 8718181006798 2XL 8718181006750	<b>MASTER CARTON INFO</b>	
XS   S   M   L   XL   2XL		QUANTITY PER M. CARTON: 40 M. CARTON WEIGHT (KG): 6 M. CARTON WEIGHT (LBS): 13,2 M. CARTON SIZE (M): 0,48X0,36X0,28 M. CARTON SIZE (INCH): 18,9X14,17X11,02	





**DETROIT FULLFACE HELMET**

ITEM NUMBER	EAN CODE	HS CODE	FEATURES
370019001	S 8718181006880 M 8718181006873 L 8718181006866	65061010	LIGHTWEIGHT POLY-INJECTED CONSTRUCTION FULL SHELL VENTING FOR IMPROVED AERODYNAMICS AND OVERALL COOLING STATE OF THE ART DESIGNED AERODYNAMIC SHELL AND ADJUSTABLE VISOR DESIGN DURABLE MULTI-COLORED CLEAR COATED GRAPHICS.
<b>SIZE</b>		<b>MASTER CARTON INFO</b>	
S   M   L		QUANTITY PER M. CARTON: 5 M. CARTON WEIGHT (KG): 4,75 M. CARTON WEIGHT (LBS): 10,45 M. CARTON SIZE (M): 1,32 X 0,4 X 0,31 M. CARTON SIZE (INCH): 51,97 X 15,55 X 12,2	



**DETROIT GOGGLE**

<i>ITEM NUMBER</i>	<i>EAN CODE</i>	<i>HS CODE</i>	<i>FEATURES</i>
420019001	PCS. 8718181007269	90041091	LIGHT-WEIGHT POLY-INJECTED CONSTRUCTION FULL SHELL VENTING FOR IMPROVED AERODYNAMICS AND OVERALL COOLING STATE OF THE ART DESIGNED AERODYNAMIC SHELL AND ADJUSTABLE VISOR DESIGN DURABLE CLEAR COATED GRAPHICS
<b>SIZE</b>		<b>MASTER CARTON INFO</b>	
PCS.		QUANTITY PER M. CARTON: 150 M. CARTON WEIGHT (KG): 100 M. CARTON WEIGHT (LBS): 220 M. CARTON SIZE (M): 11X0,5X0,4 M. CARTON SIZE (INCH): 43,3 X 19,68 X 15,75	



**GOGGLES BLACK**

ITEM NUMBER	EAN CODE	HS CODE	FEATURES
420812001	PCS. 8718181099950	90041091	COMFORTABLE DESIGN. UV 400 FLEXIBLE HEAD STRAP ADJUSTABLE HEAD STRAP POLYCARBONATE ANTI-FOG LENS
<b>SIZE</b>	<b>MASTER CARTON INFO</b>		
PCS.	QUANTITY PER M. CARTON: 100 M. CARTON WEIGHT (KG): 25,3 M. CARTON WEIGHT (LBS): 55,66 M. CARTON SIZE (M): 11X0,51X0,35 M. CARTON SIZE (INCH): 43,31X20,08X13,78		



**KNOX FLOATABLE GLASSES BLACK**

<i>ITEM NUMBER</i>	<i>EAN CODE</i>	<i>HS CODE</i>	<i>FEATURES</i>
420810001	PCS. 8718181024099	90041091	FLOATABLE GLASSES COMFORTABLE DESIGN. UV 400 FLEXIBLE HEAD STRAP ADJUSTABLE HEAD STRAP
<i>SIZE</i>	<i>MASTER CARTON INFO</i>		
PCS.	<i>QUANTITY PER M. CARTON:</i> 100 <i>M. CARTON WEIGHT (KG):</i> 18,7 <i>M. CARTON WEIGHT (LBS):</i> 41,14 <i>M. CARTON SIZE (M):</i> 0,88 X 0,39 X 0,3 <i>M. CARTON SIZE (INCH):</i> 34,65 X 15,16 X 11,81		



**KNOX FLOATABLE GLASSES BLUE**

ITEM NUMBER	EAN CODE	HS CODE	FEATURES
420506001	PCS. 8718181024013	90041091	FLOATABLE GLASSES COMFORTABLE DESIGN UV-400
<b>SIZE</b>	<b>MASTER CARTON INFO</b>		
PCS.	QUANTITY PER M. CARTON: 100 M. CARTON WEIGHT (KG): 13 M. CARTON WEIGHT (LBS): 28,6 M. CARTON SIZE (M): 0,88 X 0,39 X 0,3 M. CARTON SIZE (INCH): 34,65 X 15,16 X 11,81		



**KNOX FLOATABLE GLASSES WHITE**

ITEM NUMBER	EAN CODE	HS CODE	FEATURES
420108001	PCS. 8718181023962	90041091	FLOATABLE GLASSES COMFORTABLE DESIGN. UV-400
<b>SIZE</b>	<b>MASTER CARTON INFO</b>		
PCS.	QUANTITY PER M. CARTON: 100 M. CARTON WEIGHT (KG): 13 M. CARTON WEIGHT (LBS): 28,6 M. CARTON SIZE (M): 0,88 X 0,39 X 0,3 M. CARTON SIZE (INCH): 34,65 X 15,16 X 11,81		



**CYPRIS FLOATABLE GLASSES SILVER**

ITEM NUMBER	EAN CODE	HS CODE	FEATURES
426013002	PCS. 8718181118026	90041091	FLOATABLE GLASSES COMFORTABLE DESIGN. UV 400 FLEXIBLE HEAD STRAP ADJUSTABLE HEAD STRAP
<b>SIZE</b>	<b>MASTER CARTON INFO</b>		
PCS.	QUANTITY PER M. CARTON: 100 M. CARTON WEIGHT (KG): 13 M. CARTON WEIGHT (LBS): 28,6 M. CARTON SIZE (M): 0,88 X 0,39 X 0,3 M. CARTON SIZE (INCH): 34,65 X 15,16 X 11,81		



**KNOX FLOATABLE GLASSES SILVER**

ITEM NUMBER	EAN CODE	HS CODE	FEATURES
426013001	PCS. 8718181120319	90041091	FLOATABLE GLASSES COMFORTABLE DESIGN. UV 400
<b>SIZE</b>	<b>MASTER CARTON INFO</b>		
PCS.	QUANTITY PER M. CARTON: 100 M. CARTON WEIGHT (KG): 13 M. CARTON WEIGHT (LBS): 28,6 M. CARTON SIZE (M): 0,88 X 0,39 X 0,3 M. CARTON SIZE (INCH): 34,65 X 15,16 X 11,81		





## ANCHOR SACK

ITEM NUMBER	EAN CODE	HS CODE	FEATURES
400014003	PCS. 8718181143400	95062900	ANCHOR SACK IS IDEAL FOR ANCHORING PWCS DURABLE TRI-LAMINATE ANCHOR SACK UP TO 14 KG/35 POUNDS OF ROCKS/SAND EASY 6FT./1.82 M TIE-UP ROPE ACETYL SNAP HOOK
SIZE	MASTER CARTON INFO		
PCS.	QUANTITY PER M. CARTON:	12	
	M. CARTON WEIGHT (KG):	1,32	
	M. CARTON WEIGHT (LBS):	2,904	
	M. CARTON SIZE (M):	0,42X0,32X0,35	
	M. CARTON SIZE (INCH):	16,54X12,6X13,58	



**WRIST SEAL**

<b>ITEM NUMBER</b>	<b>EAN CODE</b>	<b>HS CODE</b>	<b>FEATURES</b>
300017553	PCS. 8718181215589	95062900	SAFETY D-RING FOR ATTACHMENT EMERGENCY CORD STRONG WRIST SEAL ADJUSTABLE
<b>SIZE</b>	<b>MASTER CARTON INFO</b>		
PCS.	QUANTITY PER M. CARTON: 200 M. CARTON WEIGHT (KG): 2 M. CARTON WEIGHT (LBS): 4,4 M. CARTON SIZE (M): 0,38X0,36X0,11 M. CARTON SIZE (INCH): 15X14X4,5		



**STAND UP PADDLING**

# AERO TECHNOLOGY

PRE-LAMINATED HEAT BONDED TECHNOLOGY

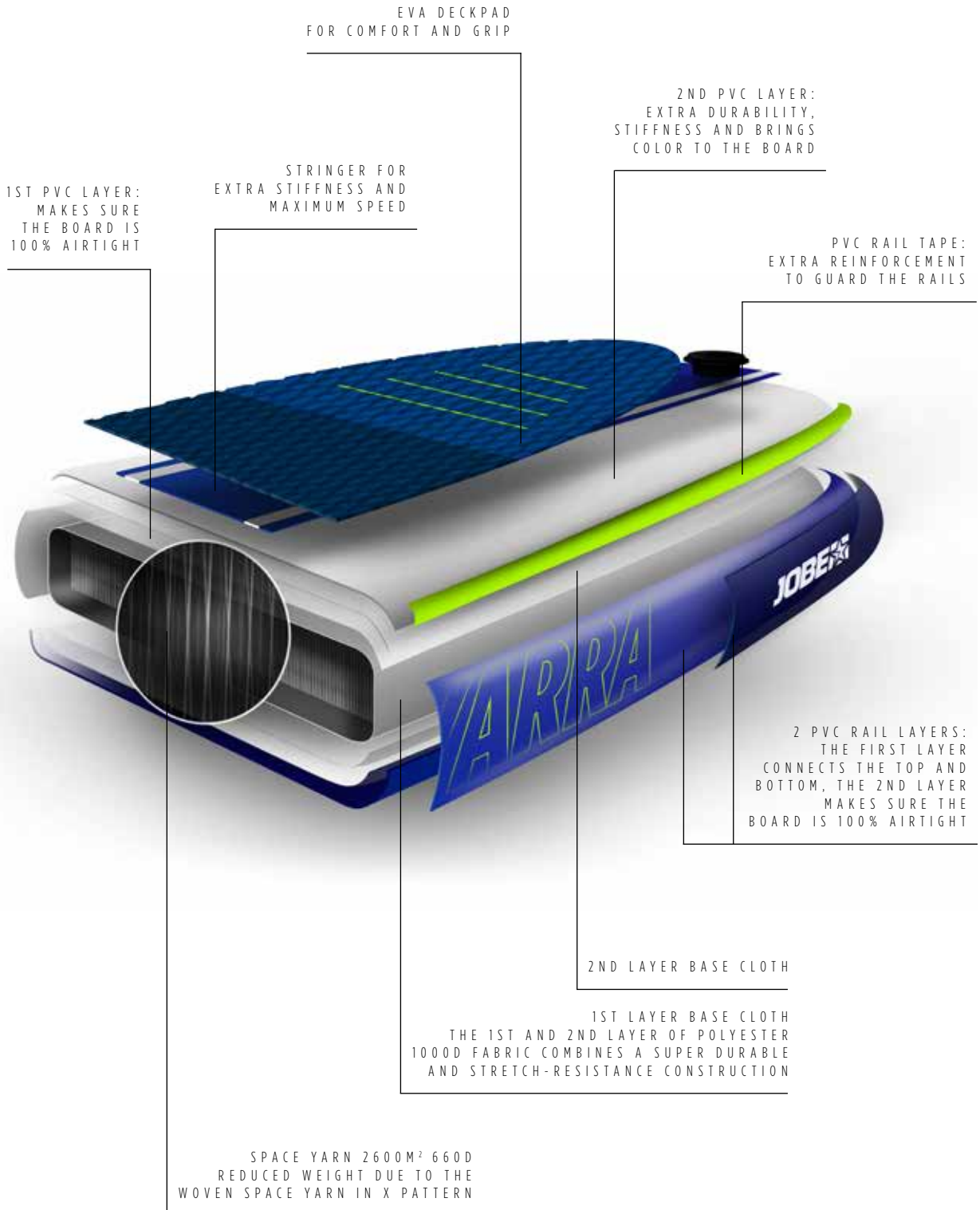

# SIZING AERO SUP

## AERO SUPS

	VENTA 9.6	DESNA 10.0	LENA 10.6
LENGTH	9'6"   289,5 CM	10'0"   305 CM	10'6"   320 CM
WIDTH	36"   91,4 CM	32"   81,3 CM	33"   83,8 CM
THICKNESS	6"   15 CM	4"   10 CM	6"   15 CM
VOLUME (L)	300	200	322
BOARD WEIGHT	10 KG   22 LBS	7,8 KG   17,5 LBS	10,8 KG   23 LBS
NOSE	FLAT	FLAT	FLAT
CENTER	FLAT	FLAT	FLAT
TAIL	FLAT	FLAT	FLAT
NOSE ROCKER	9"	7,5"	9"
TAIL ROCKER	9"	0"	0"
FIN SETUP	US CENTER FINBOX   8" NYLON CENTER FIN & MOLDED SIDE FIN	THRUSTER   MOLDED FIN ON THE BOARD	SHORT FINBOX   8" NYLON SINGLE FIN WITH HANDSCREW
RECOMMENDED RIDER WEIGHT	UP TO 120 KG   265 LBS	UP TO 90 KG   198 LBS	UP TO 120 KG   265 LBS
CATEGORY	RIVER   WINDSUP   WAVE	ALLROUND	YOGA   ALLROUND
INTENDED PLACE TO USE	LAKE   RIVER   URBAN	LAKE   RIVER   URBAN	LAKE   RIVER   URBAN   YOGA
EXTRAS	WINDSURF INSERT, SUP LEASH COIL 10FT	PACKAGE LEASH TOW	SUP LEASH COIL 10FT

	YARRA 10.6	DUNA 11.6	NEVA 12.6
LENGTH	10'6"   320 CM	11'6"   350 CM	12'6"   381 CM
WIDTH	32"   81,3 CM	31"   78,7 CM	30"   76,2 CM
THICKNESS	6"   15 CM	6"   15 CM	6"   15 CM
VOLUME (L)	310	324	320
BOARD WEIGHT	8,4 KG   18,5 LBS	8,5 KG   18,7 LBS	9,1 KG   20 LBS
NOSE	FLAT	FLAT	FLAT
CENTER	FLAT	FLAT	FLAT
TAIL	FLAT	FLAT	FLAT
NOSE ROCKER	9"	9"	9"
TAIL ROCKER	0"	0"	0"
FIN SETUP	SHORT FINBOX   8" NYLON SINGLE FIN WITH HANDSCREW	SHORT FINBOX   8" NYLON SINGLE FIN WITH HANDSCREW	SHORT FINBOX   8" NYLON SINGLE FIN WITH HANDSCREW
RECOMMENDED RIDER WEIGHT	UP TO 120 KG   265 LBS	UP TO 120 KG   265 LBS	UP TO 120 KG   265 LBS
CATEGORY	ALLROUND	ALLROUND   TOURING	TOURING
INTENDED PLACE TO USE	LAKE   RIVER   URBAN	LAKE   RIVER   URBAN	LAKE   RIVER   URBAN
EXTRAS	SUP LEASH COIL 10FT	SUP LEASH COIL 10FT	SUP LEASH COIL 10FT

	SUP'ERSIZED
LENGTH	15'0"   457 CM
WIDTH	50"   127 CM
THICKNESS	6"   15 CM
VOLUME (L)	750
BOARD WEIGHT	18 KG   39,6 LBS
NOSE	FLAT
CENTER	FLAT
TAIL	FLAT
NOSE ROCKER	9"
TAIL ROCKER	0"
FIN SETUP	3 SHORT FINBOXES   3 X 8" NYLON SINGLE FIN WITH HANDSCREW
RECOMMENDED RIDER WEIGHT	UP TO 450 KG   992 LBS
CATEGORY	ALLROUND
INTENDED PLACE TO USE	LAKE   RIVER   URBAN
EXTRAS	PACKAGE LEASH BLACK TOW



WE ARE CONSTANTLY WORKING ON THE SIZING OF OUR PRODUCTS. CHECK OUT [JOBESPORTS.COM](https://www.jobesports.com) FOR THE MOST UP TO DATE, IMPROVED SIZING! ALL MEASUREMENTS ARE FOR REFERENCE ONLY.



▶ AERO SUP DRY BAG



▶ AERO SUP LEASH



▶ DOUBLE ACTION PUMP



▶ ADJUSTABLE ALUMINIUM PADDLE 3-PIECE

**AERO DESNA SUP BOARD 10.0 PACKAGE**

ITEM NUMBER	EAN CODE	HS CODE	FEATURES
486419002	PCS. 8718181007801	95062900	LENGTH: 10'0" (3,05 M)   WIDTH: 32" (81,3 CM)   THICKNESS: 4'0" (10,0 CM)   VOLUME: 200L   RECOMMENDED RIDER WEIGHT: UP TO 90KG/ 198 LBS.   BOARD WEIGHT: 17,2 LBS. (7,8 KG)   NOSE ROCKER: 7,5", TAIL ROCKER: 0"   HEAT BONDED TECHNOLOGY: HEAT BONDED TECHNOLOGY: MORE-LAYER QUALITY AND SAFETY AND SAFETY   5MM THICK DIAMOND PATTERN EVA TRACTION DECK   HALKEY ROBERTS VALVE VALVE PATCH ASSISTANCE   D-RING CONNECTOR ON TIP AND TAIL   THREE 4.2" FLEXIBLE FINN   DOUBLE ACTION PUMP   10 FT./3.04 M STRAIGHT LEASH   ADJUSTABLE ALUMINIUM 3-PIECE PADDLE   WATERPROOF BACKPACK (WITHOUT FRONT POCKET)
SIZE	MASTER CARTON INFO		
PCS.	QUANTITY PER M. CARTON:	1	
	M. CARTON WEIGHT (KG):	16,25	
	M. CARTON WEIGHT (LBS):	35,75	
	M. CARTON SIZE (M):	0,95X0,38X0,4	
	M. CARTON SIZE (INCH):	37,25X14,96X15,75	



▶ AERO SUP DRY BAG



▶ AERO SUP LEASH



▶ DOUBLE ACTION PUMP



▶ ADJUSTABLE FIBERGLASS PADDLE 3-PIECE

**AERO YARRA SUP BOARD 10.6 PACKAGE**

ITEM NUMBER	EAN CODE	HS CODE	FEATURES
486419003	PCS. 8718181007818	95062900	LENGTH: 10'6" (3,20 M)   WIDTH: 32" (81,3 CM)   THICKNESS: 6" (15,0 CM)   VOLUME: 310L   RECOMMENDED RIDER WEIGHT: UP TO 120 KG/265 LBS.   BOARD WEIGHT: 18,5 LBS. (8,4 KG)   NOSE ROCKER: 9", TAIL ROCKER: 0"   HEAT BONDED TECHNOLOGY: HEAT BONDED TECHNOLOGY: MORE-LAYER QUALITY AND SAFETY AND SAFETY 5MM THICK DIAMOND PATTERN EVA TRACTION DECK   HALKEY ROBERTS VALVE   VALVE PATCH ASSISTANCE   D-RING CONNECTOR ON TIP AND TAIL   EASY-TO-CARRY NEOPRENE HANDLE WITH PADDLE HOLDER   8" TOOL LESS MOUNTING FIN   BUNGEE STORAGE NET   CARRYING SHOULDER STRAP   DOUBLE ACTION PUMP 10 FT./3.04 M COILED LEASH   ADJUSTABLE FIBERGLASS 3-PIECE PADDLE (JOBE FREEDOM STICK)   WATERPROOF BACKPACK
SIZE	MASTER CARTON INFO		
PCS.	QUANTITY PER M. CARTON:	1	
	M. CARTON WEIGHT (KG):	16,96	
	M. CARTON WEIGHT (LBS):	37,31	
	M. CARTON SIZE (M):	0,95 X 0,34 X 0,45	
	M. CARTON SIZE (INCH):	37,25 X 13,25 X 17,75	



▶ AERO SUP DRY BAG



▶ AERO SUP LEASH



▶ DOUBLE ACTION PUMP



▶ ADJUSTABLE FIBERGLASS PADDLE 3-PIECE

**AERO LENA SUP BOARD 10.6 YOGA PACKAGE**

ITEM NUMBER	EAN CODE	HS CODE	FEATURES
486419006	PCS. 8718181007849	95062900	LENGTH: 10'6" (320CM)   WIDTH: 33" (83,8 CM)   THICKNESS: 6" (15 CM)   VOLUME: 322L   RECOMMENDED RIDER WEIGHT: UP TO 120 KG/265 LBS.   BOARD WEIGHT: 23,8LBS. (10,8 KG)   NOSE ROCKER: 9", TAIL ROCKER: 0"   HEAT BONDED TECHNOLOGY: MORE-LAYER QUALITY AND SAFETY   5MM THICK EVA YOGA DECK   HALKEY ROBERTS VALVE   VALVE PATCH ASSISTANCE   D-RING DOCK CONNECTOR ON TIP   D-RING LEASH CONNECTOR ON TAIL   COMFORTABLE NEOPRENE CARRYING HANDLE   8" TOOL LESS MOUNTING FIN   BUNGEE STORAGE NET ON TOP   BUNGEE PADDLE NET ON THE SIDE   CARRYING SHOULDER STRAP   EXERCISE CONNECTING BUCKLES   DOUBLE ACTION PUMP   10 FT./3.04 M COILED LEASH   ADJUSTABLE FIBERGLASS 3-PIECE PADDLE (JOBE FREEDOM STICK)   WATERPROOF BACKPACK
SIZE	MASTER CARTON INFO		
PCS.	QUANTITY PER M. CARTON:	1	
	M. CARTON WEIGHT (KG):	13,94	
	M. CARTON WEIGHT (LBS):	30,67	
	M. CARTON SIZE (M):	0,98 X 0,35 X 0,45	
	M. CARTON SIZE (INCH):	38,25 X 13,75 X 17,75	





▶ AERO SUP DRY BAG



▶ AERO SUP LEASH



▶ DOUBLE ACTION PUMP



▶ ADJUSTABLE FIBERGLASS PADDLE 3-PIECE

**AERO DUNA SUP BOARD 11.6 PACKAGE**

ITEM NUMBER	EAN CODE	HS CODE	FEATURES
486419004	PCS. 8718181007825	95062900	LENGTH: 11'6" (3,50 M)   WIDTH: 31" (78,75 CM)   THICKNESS: 6" (15,0 CM)   VOLUME: 324L   RECOMMENDED RIDER WEIGHT: UP TO 120 KG/265 LBS.   BOARD WEIGHT: 18.7 LBS. (8,5 KG)   NOSE ROCKER: 9", TAIL ROCKER: 0"   HEAT BONDED TECHNOLOGY: MORE-LAYER QUALITY AND SAFETY   5MM THICK DIAMOND PATTERN EVA TRACTION DECK   HALKEY ROBERTS VALVE VALVE PATCH ASSISTANCE   D-RING CONNECTOR ON TIP AND TAIL   EASY-TO-CARRY NEOPRENE HANDLE WITH PADDLE HOLDER   8" TOOL LESS MOUNTING FIN   BUNGEE STORAGE NET CARRYING SHOULDER STRAP   DOUBLE ACTION PUMP   10 FT. COILED LEASH   ADJUSTABLE FIBERGLASS 3-PIECE PADDLE (JOBE FREEDOM STICK)   WATERPROOF BACKPACK
SIZE	MASTER CARTON INFO		
PCS.	QUANTITY PER M. CARTON:	1	
	M. CARTON WEIGHT (KG):	17,22	
	M. CARTON WEIGHT (LBS):	37,88	
	M. CARTON SIZE (M):	0,95X0,34X0,45	
	M. CARTON SIZE (INCH):	37,25X13,25X17,75	



▶ AERO SUP DRY BAG



▶ AERO SUP LEASH



▶ DOUBLE ACTION PUMP



▶ ADJUSTABLE FIBERGLASS PADDLE 3-PIECE

**AERO NEVA SUP BOARD 12.6 PACKAGE**

ITEM NUMBER	EAN CODE	HS CODE	FEATURES
486419005	PCS. 8718181007832	95062900	LENGTH: 12'6" (3,81 M)   WIDTH: 30" (76,2 CM)   THICKNESS: 6" (15 CM)   VOLUME: 320L   RECOMMENDED RIDER WEIGHT: UP TO 120 KG/265 LBS.   BOARD WEIGHT: 20 LBS. (9,1 KG)   NOSE ROCKER: 9", TAIL ROCKER: 0"   HEAT BONDED TECHNOLOGY: MORE-LAYER QUALITY AND SAFETY   5MM THICK DIAMOND PATTERN EVA TRACTION DECK   HALKEY ROBERTS VALVE VALVE PATCH ASSISTANCE   D-RING CONNECTOR ON TIP AND TAIL   EASY-TO-CARRY NEOPRENE HANDLE WITH PADDLE HOLDER   8" TOOL LESS MOUNTING FIN   BUNGEE STORAGE NET CARRYING SHOULDER STRAP   DOUBLE ACTION PUMP   10 FT. COILED LEASH   ADJUSTABLE FIBERGLASS 3-PIECE PADDLE (JOBE FREEDOM STICK)   WATERPROOF BACKPACK
SIZE	MASTER CARTON INFO		
PCS.	QUANTITY PER M. CARTON:	1	
	M. CARTON WEIGHT (KG):	17,93	
	M. CARTON WEIGHT (LBS):	39,45	
	M. CARTON SIZE (M):	0,95 X 0,34 X 0,45	
	M. CARTON SIZE (INCH):	31,25 X 13,25 X 17,75	



▶ AERO SUP DRY BAG



▶ AERO SUP LEASH



▶ DOUBLE ACTION PUMP



▶ ADJUSTABLE FIBERGLASS PADDLE 3-PIECE



▶ WINDSURF SAIL 3.5

**AERO VENTA SUP BOARD 9.6 PACKAGE + AERO VENTA SUP SAIL 3,5 M2**

ITEM NUMBER	EAN CODE	HS CODE	FEATURES
488819001	PCS. 8718181019224	95062900	LENGTH: 9'6" (2,90 M)   WIDTH: 36" (91,5 CM)   THICKNESS: 6" (15,0 CM)   VOLUME: 300L   RECOMMENDED RIDER WEIGHT: UP TO 120 KG/264 LBS.   BOARD WEIGHT: 22 LBS. (9 KG)   NOSE ROCKER: 9", TAIL ROCKER: 9"   HEAT BONDED TECHNOLOGY: MORE-LAYER QUALITY AND SAFETY AND SAFETY   5MM THICK DIAMOND PATTERN EVA TRACTION DECK   WINDSURF INSERT MOUNTED IN THE BOARD   HALKEY ROBERTS VALVE   VALVE PATCH ASSISTANCE   D-RING CONNECTOR ON TIP AND TAIL   EASY-TO-CARRY NEOPRENE HANDLE WITH PADDLE HOLDER   8" US FIN BUNGEE STORAGE NET   DOUBLE ACTION PUMP   10 FT./3.04 M COILED LEASH   ADJUSTABLE FIBERGLASS 3-PIECE PADDLE (JOBE FREEDOM STICK)   WATERPROOF BACKPACK
<b>SIZE</b>			
PCS.			
	<b>CARTON INFO BOARD</b>	<b>CARTON INFO SAIL</b>	
	QUANTITY PER M. CARTON: 1	QUANTITY PER M. CARTON: 4	
	M. CARTON WEIGHT (KG): 13	M. CARTON WEIGHT (KG): 28	
	M. CARTON WEIGHT (LBS): 28.7	M. CARTON WEIGHT (LBS): 61.7	
	M. CARTON SIZE (M): 0,96 X 0,37 X 0,5	M. CARTON SIZE (M): 1,70 X 0,43 X 0,11	
	M. CARTON SIZE (INCH): 36,6 X 14,6 X 19,7	M. CARTON SIZE (INCH): 67 X 17 X 4,35	



▶ AERO SUP DRY BAG



▶ AERO SUP LEASH



▶ DOUBLE ACTION PUMP

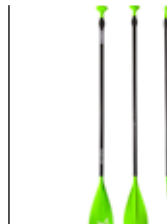

▶ ADJUSTABLE FIBERGLASS PADDLE 3-PIECE

**AERO VENTA SUP BOARD 9.6 PACKAGE**

ITEM NUMBER	EAN CODE	HS CODE	FEATURES
486419001	PCS. 8718181007795	95062900	LENGTH: 9'6" (2,90 M)   WIDTH: 36" (91,5 CM)   THICKNESS: 6" (15,0 CM)   VOLUME: 300L   RECOMMENDED RIDER WEIGHT: UP TO 120 KG/264 LBS.   BOARD WEIGHT: 22 LBS. (9 KG)   NOSE ROCKER: 9", TAIL ROCKER: 9"   HEAT BONDED TECHNOLOGY: MORE-LAYER QUALITY AND SAFETY AND SAFETY   5MM THICK DIAMOND PATTERN EVA TRACTION DECK   WINDSURF INSERT MOUNTED IN THE BOARD   HALKEY ROBERTS VALVE   VALVE PATCH ASSISTANCE   D-RING CONNECTOR ON TIP AND TAIL   EASY-TO-CARRY NEOPRENE HANDLE WITH PADDLE HOLDER   8" US FIN BUNGEE STORAGE NET   DOUBLE ACTION PUMP   10 FT./3.04 M COILED LEASH   ADJUSTABLE FIBERGLASS 3-PIECE PADDLE (JOBE FREEDOM STICK)   WATERPROOF BACKPACK
SIZE	MASTER CARTON INFO		
PCS.	QUANTITY PER M. CARTON:	1	
	M. CARTON WEIGHT (KG):	13	
	M. CARTON WEIGHT (LBS):	28.7	
	M. CARTON SIZE (M):	0,96 X 0,37 X 0,5	
	M. CARTON SIZE (INCH):	36,6 X 14,6 X 19,7	



### AERO VENTA SUP SAIL 3,5 M2

ITEM NUMBER	EAN CODE	HS CODE	FEATURES
480019002	PCS. 8718181015783	95062900	3.5M2 SAIL MAST: 316 LUFF: 316CM BOOM: 140CM INCLUDING: MAST, MAST EXTENSION, MAST BASE, UPHAUL CORD, BOOM
SIZE	MASTER CARTON INFO		
PCS.	QUANTITY PER M. CARTON:	4	
	M. CARTON WEIGHT (KG):	28	
	M. CARTON WEIGHT (LBS):	61.7	
	M. CARTON SIZE (M):	1,70 X 0,43 X 0,11	
	M. CARTON SIZE (INCH):	67 X 17 X 4.35	



**AERO SUP'ERSIZED SUP BOARD 15.0**

ITEM NUMBER	EAN CODE	HS CODE	FEATURES
486419007	PCS. 8718181007856	95062900	LENGTH: 15'0" (457.2CM)   WIDTH: 50" (127 CM) THICKNESS: 6" (15 CM) VOLUME: 750L (MAX WEIGHT: 450KG   992LBS) BOARD WEIGHT: 43 LBS (19.5 KG) 5MM THICK DIAMOND PATTERN EVA TRACTION DECK 2 HALKEY ROBERTS VALVES   VALVE PATCH ASSISTANCE D-RING CONNECTOR ON TOP 6 CARRYING HANDLES WITH PADDLE HOLDER EQUIPPED WITH 3 BIG FINS FOR MANEUVERABILITY BUNGEE STORAGE NET MAXIMUM OF 6 PERSONS
SIZE	MASTER CARTON INFO		
PCS.	QUANTITY PER M. CARTON:	1	
	M. CARTON WEIGHT (KG):	14,73	
	M. CARTON WEIGHT (LBS):	32,41	
	M. CARTON SIZE (M):	1,44X0,24X0,47	
	M. CARTON SIZE (INCH):	56,75X9,45X18,5	



**AERO HARBOR SUP DOCK**

ITEM NUMBER	EAN CODE		HS CODE	FEATURES
486418009	9FT6INCH 10FT11INCH	8718181263634 8718181263641	95062900	LENGTH: 10'11" (3,35 M) WIDTH: 10'11" (3,35 CM) EVA: 55" (139CM) THICKNESS: 6" (15,0 CM) VOLUME: 800+
<b>SIZE</b>	<b>MASTER CARTON INFO</b>			
9FT6INCH   10FT11INCH	QUANTITY PER M. CARTON: 1		WEIGHT: 16.09 KG	
	M. CARTON WEIGHT (KG): 28,48		5MM THICK EVA TRACTION DECK	
	M. CARTON WEIGHT (LBS): 62,656		16 D-RING TO CONNECT YOUR BOARD	
	M. CARTON SIZE (M): 0,92X0,29X0,71		8 TIE DOWN STRAPS	
	M. CARTON SIZE (INCH): 36,22X11,5X28		8 CUP-HOLDERS	

# TITAN TECHNOLOGY

---

EVA GRIP PAD  
FOR OPTIMUM GRIP  
AND COMFORT

POLYCARBONATE ARMOUR  
FOR SERIOUS SHOCK PROTECTION

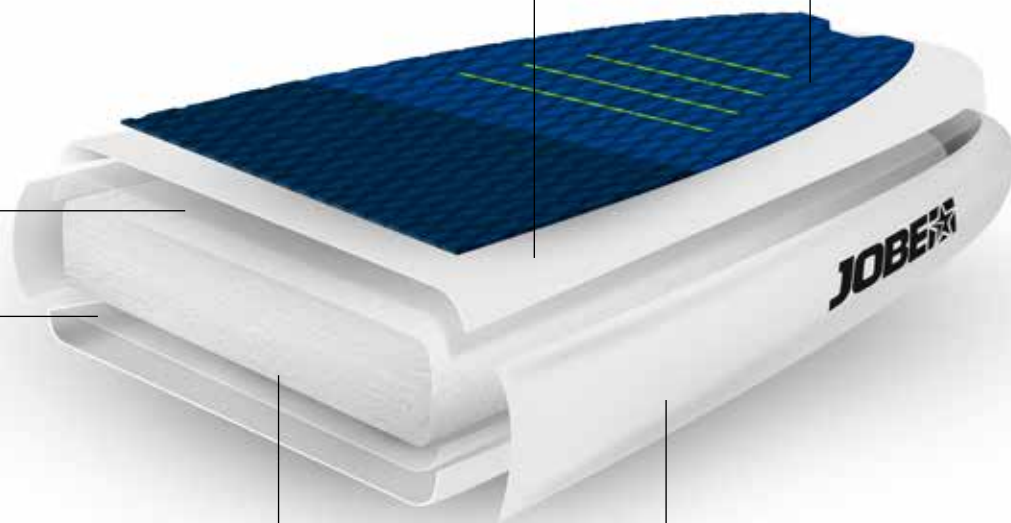

FIBERGLASS LAYER  
REINFORCES  
THE EPS CORE,  
FOR EXTRA STIFFNESS  
AND DURABILITY

PC RAIL STRIP  
TO PREVENT SCRATCHES

FIBERGLASS REINFORCED EPS CORE  
FOR THE LIGHTEST BOARD POSSIBLE



# SIZING TITAN SUP

## TITAN SUPS

	ARAS 8,6	KURA 10,6	KAMA 11,6
LENGTH	8'6"   260 CM	10'6"   320 CM	11'6"   350 CM
WIDTH	30"   76,2 CM	32"   81,3 CM	31"   78,7 CM
THICKNESS	5,5"   14 CM	5"   12,7 CM	5,25"   13,5 CM
VOLUME (L)	170	210	220
BOARD WEIGHT	11 KG   24 LBS	13,5 KG   30 LBS	14,7 KG   32 LBS
NOSE	FLAT	FLAT	FLAT
CENTER	FLAT	FLAT	FLAT
TAIL	FLAT	FLAT	FLAT
NOSE ROCKER	5"	6 1/8"	6"
TAIL ROCKER	3"	3"	3 1/4"
FIN SETUP	SINGLE FIN   BLACK NYLON: 8"	SINGLE FIN   BLACK NYLON: 8"	SINGLE FIN   BLACK NYLON: 8"
RECOMMENDED RIDER WEIGHT	UP TO 100 KG   220 LBS	UP TO 140 KG   310 LBS	UP TO 150 KG   330 LBS
CATEGORY	ALLROUND	ALLROUND	ALLROUND
INTENDED PLACE TO USE	LAKE   RIVER   URBAN   SEA	LAKE   RIVER   URBAN   SEA	LAKE   RIVER   URBAN   SEA
EXTRAS	BOARD ONLY	BOARD ONLY	BOARD ONLY

WE ARE CONSTANTLY WORKING ON THE SIZING OF OUR PRODUCTS. CHECK OUT [JOBESPORTS.COM](https://www.jobesports.com) FOR THE MOST UP TO DATE, IMPROVED SIZING!  
ALL MEASUREMENTS ARE FOR REFERENCE ONLY.





**TITAN ARAS SUP BOARD 8.6**

ITEM NUMBER	EAN CODE	HS CODE	FEATURES
486619001	PCS. 8718181007917	95062900	LENGTH: 8'6" (260M) WIDTH: 30" (76.2CM) THICKNESS: 5, 5" (14CM) VOLUME: 170 L BOARD WEIGHT: 24LBS (11KG). 5MM THICK DIAMOND PATTERN EVA TRACTION DECK EASY CONNECTABLE LEASH PLUG COMFORTABLE CARRYING HANDLE RAIL SAVER TO PREVENT SCRATCHES POLYCARBONATE ARMOUR FOR SERIOUS SHOCK PROTECTION AUTOMATIC AIR VENT PLUG
SIZE	MASTER CARTON INFO		
PCS.	QUANTITY PER M. CARTON: 1 M. CARTON WEIGHT (KG): 14,16 M. CARTON WEIGHT (LBS): 31,152 M. CARTON SIZE (M): 2,93 X 0,8 X 0,16 M. CARTON SIZE (INCH): 115,35 X 31,5 X 6,3		



### TITAN KURA SUP BOARD 10.6

ITEM NUMBER	EAN CODE	HS CODE	FEATURES
486619002	PCS. 8718181007924	95062900	LENGTH: 10'6" (3.2M) WIDTH: 32" (81.3CM) THICKNESS: 5" (12.7CM) VOLUME: 210L BOARD WEIGHT: 29.8LBS (13,5KG)
			5MM THICK DIAMOND PATTERN EVA TRACTION DECK EASY CONNECTABLE LEASH PLUG COMFORTABLE CARRYING HANDLE RAIL SAVER TO PREVENT SCRATCHES AUTOMATIC AIR VENT PLUG POLYCARBONATE ARMOUR FOR SERIOUS SHOCK PROTECTION
<b>SIZE</b>		<b>MASTER CARTON INFO</b>	
PCS.		QUANTITY PER M. CARTON: 1 M. CARTON WEIGHT (KG): 14,16 M. CARTON WEIGHT (LBS): 31,152 M. CARTON SIZE (M): 3,28X0,82X0,16 M. CARTON SIZE (INCH): 129,13X32,28X6,3	



**TITAN KAMA SUP BOARD 11.6**

ITEM NUMBER	EAN CODE	HS CODE	FEATURES
486619003	PCS. 8718181007931	95062900	LENGTH: 11'6" (350CM) WIDTH: 31" (78, 7CM) THICKNESS: 5, 25" (13, 5CM) BOARD WEIGHT: 32LBS (14, 7KG) 5MM THICK DIAMOND PATTERN EVA TRACTION DECK EASY CONNECTABLE LEASH PLUG COMFORTABLE CARRYING HANDLE RAIL SAVER TO PREVENT SCRATCHES AUTOMATIC AIR VENT PLUG POLYCARBONATE ARMOUR FOR SERIOUS SHOCK PROTECTION
SIZE	MASTER CARTON INFO		
PCS.	QUANTITY PER M. CARTON:	1	
	M. CARTON WEIGHT (KG):	20,39	
	M. CARTON WEIGHT (LBS):	44,858	
	M. CARTON SIZE (M):	3,59 X 0,83 X 0,16	
	M. CARTON SIZE (INCH):	141,34 X 32,68 X 6,3	



# BAMBOO TECHNOLOGY

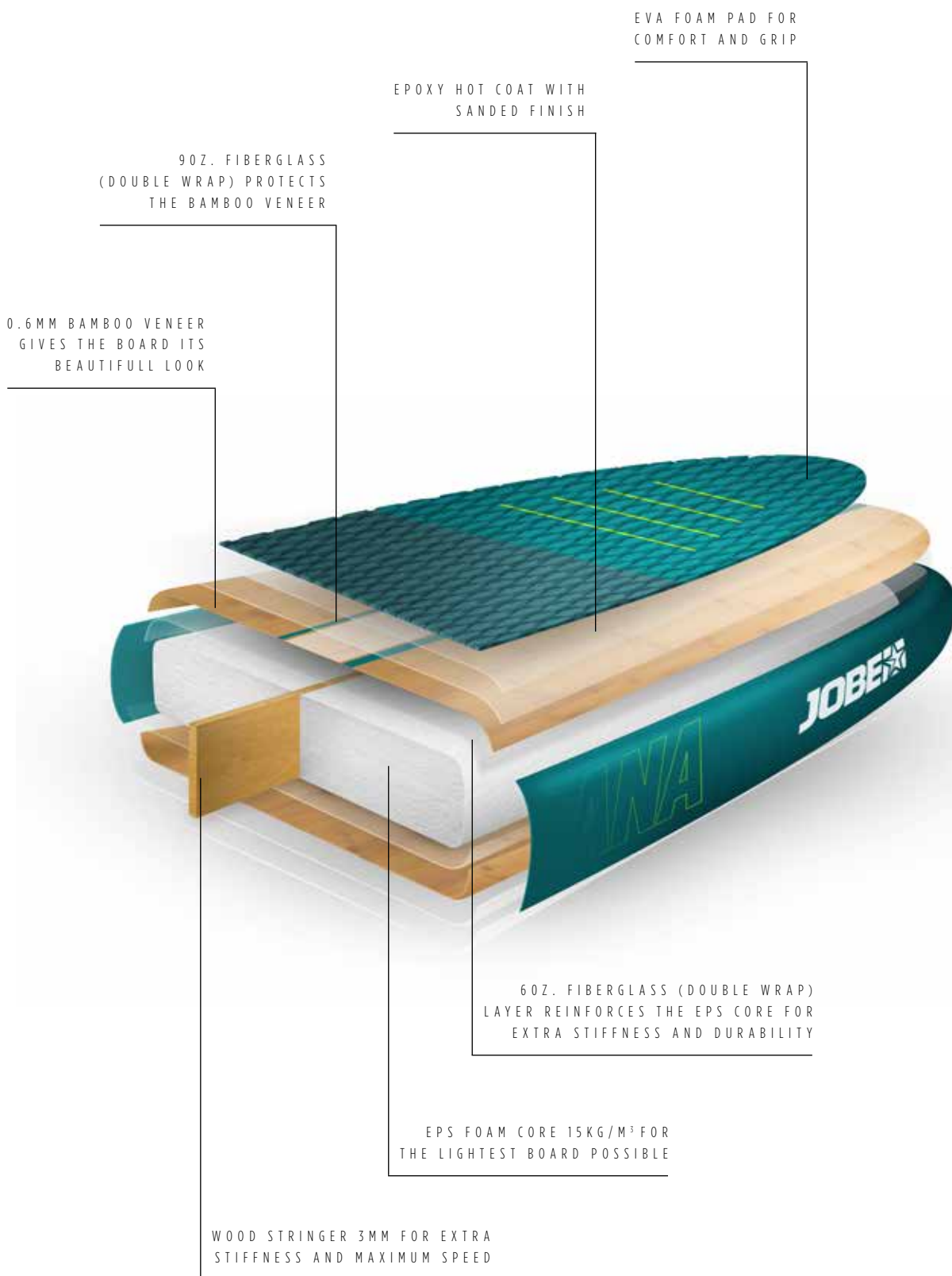

EVA FOAM PAD FOR COMFORT AND GRIP

EPOXY HOT COAT WITH SANDED FINISH

90Z. FIBERGLASS (DOUBLE WRAP) PROTECTS THE BAMBOO VENEER

0.6MM BAMBOO VENEER GIVES THE BOARD ITS BEAUTIFULL LOOK

60Z. FIBERGLASS (DOUBLE WRAP) LAYER REINFORCES THE EPS CORE FOR EXTRA STIFFNESS AND DURABILITY

EPS FOAM CORE 15KG/M<sup>3</sup> FOR THE LIGHTEST BOARD POSSIBLE

WOOD STRINGER 3MM FOR EXTRA STIFFNESS AND MAXIMUM SPEED

# SIZING BAMBOO SUP

## BAMBOO SUPS

	VIZELA 9,4	VENTURA 10,6	SONORA 10,6 YOGA	PARANA 11,6	ANGARA 12,6
LENGTH	9'4"   285 CM	10'6"   320 CM	10'6"   320 CM	11'6"   350 CM	12'6"   381 CM
WIDTH	32"   81,3 CM	32"   81,3 CM	32"   81,3 CM	31"   78,75 CM	29"   73,65 CM
THICKNESS	4,5"   11,43 CM	5"   12,7 CM	5"   12,7 CM	5"   12,7 CM	5,5"   13,97 CM
VOLUME (L)	150	190	190	203	210
BOARD WEIGHT	11 KG   24 LBS	13,5 KG   30 LBS	13,5 KG   30 LBS	14,7 KG   32 LBS	12,9 KG   28 LBS
NOSE	SINGLE CONCAVE	SINGLE CONCAVE	FLAT	SINGLE CONCAVE	SHAPED
CENTER	FLAT	FLAT	FLAT	FLAT	FLAT
TAIL	DOUBLE CONCAVE	DOUBLE CONCAVE WITH CHANNELS	FLAT	DOUBLE CONCAVE WITH CHANNELS	FLAT
NOSE ROCKER	6 3/4"	6 3/4"	5"	5 15/16"	5 7/8"
TAIL ROCKER	3 13/16"	2 15/16"	3"	3 3/16"	1"
FIN SETUP	THRUSTER   FIBERGLASS: 6" CENTER + NYLON 4,5" SIDE	SINGLE FIN   FIBERGLASS: 9"	SINGLE FIN   FIBERGLASS: 9"	SINGLE FIN   FIBERGLASS: 9"	SINGLE FIN   FIBERGLASS RACE: 12"
RECOMMENDED RIDER WEIGHT	UP TO 100 KG   220LBS	UP TO 110 KG   243 LBS	UP TO 110 KG   243 LBS	UP TO 120 KG   265 LBS	UP TO 120 KG   265 LBS
CATEGORY	SURF BEGINNER	ALLROUND   FLAT WATER	YOGA   ALLROUND	ALLROUND   FLAT WATER	TOURING
INTENDED PLACE TO USE	SEA   LAKE   RIVER   URBAN	SEA   LAKE   RIVER   URBAN	LAKE   RIVER   URBAN   YOGA	LAKE   RIVER   URBAN	LAKE   RIVER   URBAN   SEA
EXTRAS	SUP LEASH STRAIGHT 9FT   RAIL SAVER	SUP LEASH STRAIGHT 9FT   RAIL SAVER	SUP LEASH COIL 9FT   RAIL SAVER	SUP LEASH COIL 9 FT   RAIL SAVER	SUP LEASH COIL 9 FT   RAIL SAVER

WE ARE CONSTANTLY WORKING ON THE SIZING OF OUR PRODUCTS. CHECK OUT [JOBESPORTS.COM](https://www.jobesports.com) FOR THE MOST UP TO DATE, IMPROVED SIZING! ALL MEASUREMENTS ARE FOR REFERENCE ONLY.





**BAMBOO VIZELA SUP BOARD 9.4**

ITEM NUMBER	EAN CODE	HS CODE	FEATURES
486519001	PCS. 8718181007863	95062900	LENGTH: 9'4" (285CM)   WIDTH: 32" (81,3CM) THICKNESS: 4,5" (11,4CM)   VOLUME (L): 150 RECOMMENDED RIDER WEIGHT: UP TO 100 KG/220 LBS BOARD WEIGHT: 24 LBS (11KG) NOSE ROCKER: 6 3/4", TAIL ROCKER: 3 13/16" 9 FT STRAIGHT LEASH   5MM THICK DIAMOND PATTERN EVA TRACTION DECK   EASY CONNECTABLE LEASH PLUG CAMERA PLUG TO CAPTURE ALL YOUR #JOBEMOMENTS COMFORTABLE CARRYING HANDLE AUTOMATIC AIR VENT PLUG   US FINBOX FOR OPTIMAL FIN POSITION   THRUSTER FIN FOR WAVES (6" CENTER + 4.5" SIDE FIN)   RAIL SAVER TO PREVENT SCRATCHES"
SIZE	MASTER CARTON INFO		
PCS.	QUANTITY PER M. CARTON:	1	
	M. CARTON WEIGHT (KG):	12,46	
	M. CARTON WEIGHT (LBS):	27,412	
	M. CARTON SIZE (M):	3 X 0,87 X 0,14	
	M. CARTON SIZE (INCH):	118,11 X 34,25 X 5,51	





**BAMBOO VENTURA SUP BOARD 10.6**

ITEM NUMBER	EAN CODE	HS CODE	FEATURES
486519002	PCS. 8718181007870	95062900	LENGTH: 10'6" (320CM)   WIDTH: 32" (81.3CM) THICKNESS: 5" (12.5CM)   VOLUME: 190L RECOMMENDED RIDER WEIGHT: UP TO 110 KG/243 LBS. WEIGHT: 30 LBS (13, 5 KG) NOSE ROCKER: 6 3/4", TAIL ROCKER: 2 15/16" BAMBOO VENEER   9 FT. STRAIGHT LEASH   5MM THICK DIAMOND PATTERN EVA TRACTION DECK   EASY-TO-CONNECT LEASH PLUG   CAMERA PLUG TO CAPTURE ALL #JOBEMOMENTS COMFORTABLE CARRYING HANDLE   9" TOOL LESS FIN   US FIN BOX FOR OPTIMAL FIN POSITION   BUNGEE STORAGE NET CHANNELS FOR BETTER SPEED CONTROL AND STABILITY   RAIL SAVER TO PREVENT SCRATCHES   AUTOMATIC AIR VENT PLUG
SIZE	MASTER CARTON INFO		
PCS.	QUANTITY PER M. CARTON:	1	
	M. CARTON WEIGHT (KG):	12,46	
	M. CARTON WEIGHT (LBS):	27,412	
	M. CARTON SIZE (M):	3,36 X 0,87 X 0,14	
	M. CARTON SIZE (INCH):	132,28 X 34,25 X 5,51	



**BAMBOO SONORA SUP BOARD 10.6 YOGA**

ITEM NUMBER	EAN CODE	HS CODE	FEATURES
486518005	PCS. 8718181247252	95062900	LENGTH: 10'6" (320CM)   WIDTH: 32" (81,3CM) THICKNESS: 5" (12,7CM)   VOLUME: 190L. RECOMMENDED RIDER WEIGHT: UP TO 110 KG/243 LBS. BOARD WEIGHT: 30LBS (13,5KG) NOSE ROCKER: 5", TAIL ROCKER: 3"
<b>SIZE</b>		<b>MASTER CARTON INFO</b>	
PCS.		QUANTITY PER M. CARTON: 1 M. CARTON WEIGHT (KG): 14,96 M. CARTON WEIGHT (LBS): 32,912 M. CARTON SIZE (M): 3,36 X 0,87 X 0,14 M. CARTON SIZE (INCH): 13,28 X 34,25 X 5,51	BAMBOO VENEER   9 FT./2,74 M STRAIGHT LEASH 5MM THICK DIAMOND PATTERN EVA TRACTION DECK EASY-TO-CONNECT LEASH PLUG   CAMERA PLUG TO CAPTURE ALL #JOBEMOMENTS   COMFORTABLE CARRYING HANDLE 9" TOOL LESS FIN   US FIN BOX FOR OPTIMAL FIN POSITION RAIL SAVER TO PREVENT SCRATCHES   BUNGEE STORAGE NET AND PADDLE NET ON THE SIDE   AUTOMATIC AIR VENT PLUG



### BAMBOO PARANA SUP BOARD 11.6

ITEM NUMBER	EAN CODE	HS CODE	FEATURES
486519003	PCS. 8718181007887	95062900	LENGTH: 11'6" (3.5M)   WIDTH: 31" (78.7CM) THICKNESS: 5" (12.7CM)   VOLUME: 203L RECOMMENDED RIDER WEIGHT: UP TO 120 KG/265 LBS. BOARD WEIGHT: LBS: 32,4 (14, 7KG). NOSE ROCKER: 5 15/16", TAIL ROCKER: 3 3/16"
SIZE	MASTER CARTON INFO		
PCS.	QUANTITY PER M. CARTON: 1 M. CARTON WEIGHT (KG): 16,66 M. CARTON WEIGHT (LBS): 36,652 M. CARTON SIZE (M): 3,68 X 0,85 X 0,14 M. CARTON SIZE (INCH): 144,88 X 33,46 X 5,51		BAMBOO VENEER   9 FT./2.74 M STRAIGHT LEASH   5MM THICK DIAMOND PATTERN EVA TRACTION DECK   EASY-TO-CONNECT LEASH PLUG   AUTOMATIC AIR VENT PLUG CAMERA PLUG TO CAPTURE ALL #JOBEMOMENTS   COMFORTABLE CARRYING HANDLE   9" TOOL LESS FIN   US FIN BOX FOR OPTIMAL FIN POSITION   STABILITY AND SPEED CONTROL CHANNELS   RAIL SAVER TO PREVENT SCRATCHES   BUNGEE STORAGE NET



**BAMBOO ANGARA SUP BOARD 12.6**

ITEM NUMBER	EAN CODE	HS CODE	FEATURES
486519004	PCS. 8718181007894	95062900	LENGTH: 12'6" (3.81M)   WIDTH: 29" (73.7CM) THICKNESS: 5,5" (14CM)   VOLUME: 210L RECOMMENDED RIDER WEIGHT: UP TO 120 KG/265 LBS. BOARD WEIGHT: 28 LBS (12,9KG). NOSE ROCKER: 5 7/8", TAIL ROCKER: 1" BAMBOO VENEER   9 FT. STRAIGHT LEASH 5MM THICK GROOVED EVA TRACTION DECK EASY-TO-CONNECT LEASH PLUG   AUTOMATIC AIR VENT PLUG CAMERA PLUG TO CAPTURE #JOBEMOMENTS COMFORTABLE CARRYING HANDLE 12" TOOL LESS FIN   US FIN BOX FOR OPTIMAL FIN POSITION BUNGEE STORAGE NET   RAIL SAVER TO PREVENT SCRATCHES
SIZE	MASTER CARTON INFO		
PCS.	QUANTITY PER M. CARTON:	1	
	M. CARTON WEIGHT (KG):	14,62	
	M. CARTON WEIGHT (LBS):	32,164	
	M. CARTON SIZE (M):	3,89 X 0,79 X 0,19	
	M. CARTON SIZE (INCH):	15,35 X 31,1 X 7,48	



### ADDICT SUP BOAT RACK

ITEM NUMBER	EAN CODE	HS CODE	FEATURES
400019001	PCS. 8718181000710	76169990	FITS 7/8", 1" & 1-1/4" RAILS   061 ALUMINUM ALLOY, SANDBLASTED ANODIZED HEAT PRESS, DIE CUT, EVA PROTECTIVE FOAM   HEAVY DUTY SHOCK CORDS KEEP BOARDS IN PLACE
SIZE	MASTER CARTON INFO		
PCS.	QUANTITY PER M. CARTON:	1	
	M. CARTON WEIGHT (KG):	0,99	
	M. CARTON WEIGHT (LBS):	2,18	
	M. CARTON SIZE (M):	0,65X0,27X0,12	
	M. CARTON SIZE (INCH):	25,59X10,63X4,72	



**ADDICT SUP BOAT RACK CLAMPS**

ITEM NUMBER	EAN CODE	HS CODE	FEATURES
409919001	PCS. 8718181000727	76169990	FITS 7/8", 1" & 1-1/4" RAILS 061 ALUMINUM ALLOY SANDBLASTED ANODIZED
<b>SIZE</b>	<b>MASTER CARTON INFO</b>		
PCS.	QUANTITY PER M. CARTON: 100		
	M. CARTON WEIGHT (KG): 99		
	M. CARTON WEIGHT (LBS): 218		
	M. CARTON SIZE (M): 0,33X0,31X0,23		
	M. CARTON SIZE (INCH): 12,99X12,20X9,06		



### ALUMINIUM PADDLE 3 PCS.

ITEM NUMBER	EAN CODE	HS CODE	FEATURES
486719001	PCS. 8718181007948	95062900	LENGTH: 170 TO 210CM 3PC BLADE WIDTH: 189MM, 7. INCH WEIGHT: 980G BLADE SURFACE: 87 IN2 BLADE ANGLE: 9 PIN-HOLE CLICK AND GO ADJUSTMENT LIGHT AND STIFF ALUMINIUM SHAFT PLASTIC BLADE COMFORTABLE T-GRIP
SIZE	MASTER CARTON INFO		
PCS.		QUANTITY PER M. CARTON: 6 M. CARTON WEIGHT (KG): 6,3 M. CARTON WEIGHT (LBS): 13,86 M. CARTON SIZE (M): 0,91X0,24X0,14 M. CARTON SIZE (INCH): 35,83X9,45X5,51	



**FREEDOM STICK YOUTH**

ITEM NUMBER	EAN CODE	HS CODE	FEATURES
486719002	PCS. 8718181007955	95062900	LENGTH: 137 TO 171CM 2PC BLADE WIDTH: 180 MM, 7.1 INCH BLADE SURFACE: 84 IN2 BLADE ANGLE: 9 WEIGHT: 780G PLASTIC BLADE PIN-HOLE CLICK AND GO ADJUSTMENT FIBERGLASS SHAFT WITH EXCELLENT FLEX/WEIGHT RATIO COMFORTABLE FIBERGLASS T-GRIP
<b>SIZE</b>	<b>MASTER CARTON INFO</b>		
PCS.	QUANTITY PER M. CARTON: 6 M. CARTON WEIGHT (KG): 4,56 M. CARTON WEIGHT (LBS): 10,032 M. CARTON SIZE (M): 0,91X0,24X0,14 M. CARTON SIZE (INCH): 35,83X9,45X5,51		





### **FREEDOM STICK 3 PCS.**

<b>ITEM NUMBER</b>	<b>EAN CODE</b>	<b>HS CODE</b>	<b>FEATURES</b>
486719009	PCS. 8718181008020	95062900	LENGTH: 169 TO 205CM 3PC. BLADE WIDTH: 215MM, 8.5INCH WEIGHT: 940 G BLADE SURFACE: 95 IN2 BLADE ANGLE: 10 PLASTIC BLADE PIN-HOLE CLICK AND GO ADJUSTMENT FIBERGLASS SHAFT WITH EXCELLENT FLEX/WEIGHT RATIO COMFORTABLE PLASTIC T-GRIP
		<b>MASTER CARTON INFO</b>	
		QUANTITY PER M. CARTON:	6
		M. CARTON WEIGHT (KG):	6,3
		M. CARTON WEIGHT (LBS):	13,86
		M. CARTON SIZE (M):	0,91X0,24X0,14
		M. CARTON SIZE (INCH):	35,83X9,45X5,51



### FIBERGLASS PADDLE 3 PCS. BLUE

ITEM NUMBER	EAN CODE	HS CODE	FEATURES
486719003	PCS. 8718181007962	95062900	LENGTH: 180 TO 220CM 3PC. BLADE WIDTH: 8 INCH/20.32 CM WEIGHT: 780G BLADE SURFACE: 91 IN2 BLADE ANGLE: 9 FIBERGLASS BLADE CLIP WITH LEVER TO ADJUST FAST AND EASY FIBERGLASS SHAFT WITH EXCELLENT FLEX/WEIGHT RATIO COMFORTABLE FIBERGLASS T-GRIP
SIZE	MASTER CARTON INFO		
PCS.	QUANTITY PER M. CARTON:	20	
	M. CARTON WEIGHT (KG):	20,4	
	M. CARTON WEIGHT (LBS):	44,88	
	M. CARTON SIZE (M):	1,85X0,3X0,3	
	M. CARTON SIZE (INCH):	72,83X11,81X11,81	



### FIBERGLASS PADDLE 3 PCS. TEAL

ITEM NUMBER	EAN CODE	HS CODE	FEATURES
486719004	PCS. 8718181007979	95062900	LENGTH: 180 TO 220CM 3PC. BLADE WIDTH: 8 INCH/20.32 CM WEIGHT: 780G BLADE SURFACE: 91 IN2 BLADE ANGLE: 9 FIBERGLASS BLADE CLIP WITH LEVER TO ADJUST FAST AND EASY FIBERGLASS SHAFT WITH EXCELLENT FLEX/WEIGHT RATIO COMFORTABLE FIBERGLASS T-GRIP
<b>SIZE</b>		<b>MASTER CARTON INFO</b>	
PCS.		QUANTITY PER M. CARTON: 20 M. CARTON WEIGHT (KG): 20,4 M. CARTON WEIGHT (LBS): 44,88 M. CARTON SIZE (M): 1,85X0,3X0,3 M. CARTON SIZE (INCH): 72,83X11,81X11,81	



### FIBERGLASS PADDLE 3 PCS. BLACK

ITEM NUMBER	EAN CODE	HS CODE	FEATURES
486719005	PCS. 8718181007986	95062900	LENGTH: 180 TO 220CM 3PC. BLADE WIDTH: 8 INCH/20.32 CM WEIGHT: 780G BLADE SURFACE: 91 IN2 BLADE ANGLE: 9 FIBERGLASS BLADE CLIP WITH LEVER TO ADJUST FAST AND EASY FIBERGLASS SHAFT WITH EXCELLENT FLEX/WEIGHT RATIO COMFORTABLE FIBERGLASS T-GRIP
SIZE	MASTER CARTON INFO		
PCS.	QUANTITY PER M. CARTON:	20	
	M. CARTON WEIGHT (KG):	20,4	
	M. CARTON WEIGHT (LBS):	44,88	
	M. CARTON SIZE (M):	1,85X0,3X0,3	
	M. CARTON SIZE (INCH):	72,83X11,81X11,81	



### PADDLE BAMBOO CLASSIC

ITEM NUMBER	EAN CODE	HS CODE	FEATURES
486719006	PCS. 8718181007993	95062900	LENGTH: 180 TO 220CM 3PC. BLADE WIDTH: 8 INCH/20.32 CM WEIGHT: 780G BLADE SURFACE: 91 IN2 BLADE ANGLE: 9 FIBERGLASS BLADE CLIP WITH LEVER TO ADJUST FAST AND EASY BAMBOO SHAFT WITH EXCELLENT FLEX/WEIGHT RATIO COMFORTABLE FIBERGLASS T-GRIP
SIZE	MASTER CARTON INFO		
PCS.	QUANTITY PER M. CARTON:	20	
	M. CARTON WEIGHT (KG):	17,6	
	M. CARTON WEIGHT (LBS):	38,72	
	M. CARTON SIZE (M):	1,85X0,3X0,3	
	M. CARTON SIZE (INCH):	72,83X11,81X11,81	



**CARBON PRO PADDLE 2 PCS.**

ITEM NUMBER	EAN CODE	HS CODE	FEATURES
486719008	PCS. 8718181008013	95062900	LENGTH: 180 TO 220CM 2PC. BLADE WIDTH: 206MM, 8.1INCH WEIGHT: 630G BLADE SURFACE: 93.3 IN2 BLADE ANGLE: 10 CLIP WITH LEVER TO ADJUST FAST AND EASY STIFF CARBON SHAFT FOR THE BEST RESPONSE LIGHTWEIGHT CARBON BLADE COMFORTABLE CARBON T-GRIP ABS PROTECTOR ON EDGE COMES WITH BLADE COVER
<b>SIZE</b>	<b>MASTER CARTON INFO</b>		
PCS.	QUANTITY PER M. CARTON: 6 M. CARTON WEIGHT (KG): 4,74 M. CARTON WEIGHT (LBS): 10,428 M. CARTON SIZE (M): 1,82X0,32X0,15 M. CARTON SIZE (INCH): 71,65 X12,6 X5,91		



### CARBON PRO PADDLE 3 PCS.

ITEM NUMBER	EAN CODE	HS CODE	FEATURES
486719007	PCS. 8718181008006	95062900	LENGTH: 180 TO 220CM 3PC. BLADE WIDTH: 206MM, 8.1INCH WEIGHT: 680G BLADE SURFACE: 93.3 IN2 BLADE ANGLE: 10 CLIP WITH LEVER TO ADJUST FAST AND EASY STIFF CARBON SHAFT FOR THE BEST RESPONSE LIGHTWEIGHT CARBON BLADE COMFORTABLE CARBON T-GRIP ABS PROTECTOR ON EDGE COMES WITH BLADE COVER
<b>SIZE</b>		<b>MASTER CARTON INFO</b>	
PCS.		QUANTITY PER M. CARTON: 6 M. CARTON WEIGHT (KG): 4,32 M. CARTON WEIGHT (LBS): 9,504 M. CARTON SIZE (M): 0,99X0,32X0,2 M. CARTON SIZE (INCH): 38,98X12,6X7,87	



**CARBON PRO PADDLE 3 PCS. - PADDLE BAG**

ITEM NUMBER	EAN CODE	HS CODE	FEATURES
486719101	PCS. 8718181013901	95062900	PADDLE: LENGTH: 180 TO 220CM 3PC. BLADE WIDTH: 206MM, 8.1INCH WEIGHT: 680G BLADE SURFACE: 93.3 IN2 BLADE ANGLE: 10 CLIP WITH LEVER TO ADJUST FAST AND EASY STIFF CARBON SHAFT FOR THE BEST RESPONSE LIGHTWEIGHT CARBON BLADE   COMFORTABLE CARBON T-GRIP ABS PROTECTOR ON EDGE PADDLE BAG: FOLDABLE TO 100CM WITH STRAP FOR EASY CARRYING
<b>SIZE</b>		<b>MASTER CARTON INFO</b>	
PCS.		QUANTITY PER M. CARTON: 6 M. CARTON WEIGHT (KG): 0,06 M. CARTON WEIGHT (LBS): 0,132 M. CARTON SIZE (M): 1,82X0,32X0,15 M. CARTON SIZE (INCH): 71,65 X12,6 X5,91	







### SUP PUMP DOUBLE ACTION 27 PSI

ITEM NUMBER	EAN CODE	HS CODE	FEATURES
480018001	PCS. 8718181244541	84142080	DOUBLE OR SINGLE ACTION UP TO 27 PSI (1.9 BAR) 2000 CM3 CYLINDER FOR QUICK RESULT FINISH EFFORTLESSLY BY SWITCHING TO SINGLE ACTION GAUGE TO KEEP CONTROL HALKEY ROBERTS NOZZLE: FITS ALL JOBE INFLATABLE BOARDS
SIZE	MASTER CARTON INFO		
PCS.	QUANTITY PER M. CARTON: 4 M. CARTON WEIGHT (KG): 6,4 M. CARTON WEIGHT (LBS): 14,08 M. CARTON SIZE (M): 0,59 X 0,32 X 0,68 M. CARTON SIZE (INCH): 23,23 X 12,6 X 26,77		



### TRIPLE ACTION SUP PUMP

ITEM NUMBER	EAN CODE	HS CODE	FEATURES
410019004	PCS. 8718181007252	84148080	2 CYLINDERS WITH TRIPLE ACTION FOR QUICK RESULT DOUBLE OR SINGLE ACTION UP TO 21 PSI CAPACITY 3.5 + 3.5 L GAUGE TO KEEP CONTROL HALKEY ROBERTS NOZZLE: FITS ALL JOBE INFLATABLE BOARDS
SIZE	MASTER CARTON INFO		
PCS.	QUANTITY PER M. CARTON:	6	
	M. CARTON WEIGHT (KG):	3,96	
	M. CARTON WEIGHT (LBS):	8,71	
	M. CARTON SIZE (M):	0,57X0,35X0,66	
	M. CARTON SIZE (INCH):	22,4X13,8X26	



**SUP PUMP 12V**

ITEM NUMBER	EAN CODE	HS CODE	FEATURES
410017203	PCS. 8718181238557	84148080	DIMENSION 29.5X13.5X16 CM 12V PUMP CAR BATTERY ALLIGATOR CLIPS CABLE CIGARETTE LIGHTER CONNECTOR FAST TWO-STAGE LOW-TO-HIGH PRESSURE INFLATION PUMPS UP TO 20 PSI
<b>SIZE</b>		<b>MASTER CARTON INFO</b>	
PCS.		QUANTITY PER M. CARTON: 4 M. CARTON WEIGHT (KG): 9,08 M. CARTON WEIGHT (LBS): 19,976 M. CARTON SIZE (M): 0,41X0,35X0,41 M. CARTON SIZE (INCH): 16,25X1,375X1,6	



**PORTABLE ELECTRIC AIR PUMP**

ITEM NUMBER	EAN CODE	HS CODE	FEATURES
410018001	PCS. 8718181254120	84148080	DIMENSIONS: 20X20X14 CM BATTERY POWERED PUMP INCLUDES 4 DIFFERENT NOZZLES HANDLE FOR EASY CARRYING PUMPS UP TO 20 PSI
<b>SIZE</b>	<b>MASTER CARTON INFO</b>		
PCS.	QUANTITY PER M. CARTON: 6 M. CARTON WEIGHT (KG): 4,88 M. CARTON WEIGHT (LBS): 10,74 M. CARTON SIZE (M): 0,56X0,34X0,62 M. CARTON SIZE (INCH): 22,05X13,39X24,41		INFLATES AND DEFLATES EU AND UK PLUG CIGARETTE LIGHTER CONNECTOR



### SUP BAG 9.4

ITEM NUMBER	EAN CODE	HS CODE	FEATURES
222018001	PCS. 8718181263832	42029291	PROTECTIVE 9.4 SUP BAG FULLY PROTECTION PADDED EXTRA PROTECTION ON THE NOSE AND TAIL ZIPPER-PROTECTION NYLON COVER WITH A TARPULIN LAYER TO KEEP YOUR SUP DRY SAFETY POCKET INSIDE FOR FINS AND TOOLS REMOVABLE SHOULDER STRAP PADDLE HOLDER ON THE BOTTOM
SIZE	MASTER CARTON INFO		
PCS.	QUANTITY PER M. CARTON:	8	
	M. CARTON WEIGHT (KG):	35,2	
	M. CARTON WEIGHT (LBS):	77,44	
	M. CARTON SIZE (M):	0,99X0,7X0,6	
	M. CARTON SIZE (INCH):	38,98X27,56X23,62	



## SUP BAG 10.6

ITEM NUMBER	EAN CODE	HS CODE	FEATURES
222018002	PCS. 8718181263849	42029291	PROTECTIVE 10.6 SUP BAG FULLY PROTECTION PADDED EXTRA PROTECTION ON THE NOSE AND TAIL ZIPPER-PROTECTION TO PROTECT YOUR SUP-BOARD NYLON COVER WITH A TARPULIN LAYER TO KEEP YOUR PADDLE BOARD DRY SAFETY POCKET INSIDE FOR FINS AND TOOLS REMOVABLE SHOULDER STRAP PADDLE HOLDER ON THE BOTTOM
SIZE	MASTER CARTON INFO		
PCS.	QUANTITY PER M. CARTON:	7	
	M. CARTON WEIGHT (KG):	30,8	
	M. CARTON WEIGHT (LBS):	67,76	
	M. CARTON SIZE (M):	0,99X0,7X0,6	
	M. CARTON SIZE (INCH):	38,98X27,56X23,62	



**SUP BAG 11.6**

ITEM NUMBER	EAN CODE	HS CODE	FEATURES
222018003	PCS. 8718181263856	42029291	PROTECTIVE 11.6 SUP BAG FULLY PROTECTION PADDED EXTRA PROTECTION ON THE NOSE AND TAIL ZIPPER-PROTECTION TO PROTECT YOUR SUP-BOARD NYLON COVER WITH A TARPULIN LAYER TO KEEP YOUR PADDLE BOARD DRY SAFETY POCKET INSIDE FOR FINS AND TOOLS REMOVABLE SHOULDER STRAP PADDLE HOLDER ON THE BOTTOM
SIZE	MASTER CARTON INFO		
PCS.	QUANTITY PER M. CARTON:	7	
	M. CARTON WEIGHT (KG):	30,8	
	M. CARTON WEIGHT (LBS):	67,76	
	M. CARTON SIZE (M):	0,99X0,7X0,6	
	M. CARTON SIZE (INCH):	38,98X27,56X23,62	



**SUP BAG 12.6**

<b>ITEM NUMBER</b>	<b>EAN CODE</b>	<b>HS CODE</b>	<b>FEATURES</b>
222018004	PCS. 8718181263863	42029291	PROTECTIVE 12.6 SUP BAG FULLY PROTECTION PADDED EXTRA PROTECTION ON THE NOSE AND TAIL ZIPPER-PROTECTION NYLON COVER WITH A TARPULIN LAYER TO KEEP YOUR PADDLE BOARD DRY SAFETY POCKET INSIDE FOR FINS AND TOOLS REMOVABLE SHOULDER STRAP
<b>SIZE</b>		<b>MASTER CARTON INFO</b>	
PCS.		QUANTITY PER M. CARTON: 5 M. CARTON WEIGHT (KG): 22 M. CARTON WEIGHT (LBS): 48,4 M. CARTON SIZE (M): 0,99X0,7X0,6 M. CARTON SIZE (INCH): 38,98X27,56X23,62	



### ALL-IN ONE PADDLE BAG

ITEM NUMBER	EAN CODE	HS CODE	FEATURES
222019001	PCS. 8718181013819	42029291	FOLDABLE TO 100CM WITH STRAP FOR EASY CARRYING SUITED FOR 3PC, 2PC AND FIXED PADDLES
SIZE	MASTER CARTON INFO		
PCS.	QUANTITY PER M. CARTON:	50	
	M. CARTON WEIGHT (KG):	0,5	
	M. CARTON WEIGHT (LBS):	1,1	
	M. CARTON SIZE (M):	0,92X0,73X0,6	
	M. CARTON SIZE (INCH):	36,22X28,74X23,62	



### WATERPROOF GADGET BAG

ITEM NUMBER	EAN CODE	HS CODE	FEATURES
420016001	PCS. 8718181199957	42029291	WATERPROOF FLOATABLE NECK LEASH ATTACHMENT HOOK MAKE CALLS, PHOTOS & VIDEOS
SIZE	MASTER CARTON INFO		
PCS.	QUANTITY PER M. CARTON:	150	
	M. CARTON WEIGHT (KG):	10,5	
	M. CARTON WEIGHT (LBS):	23,1	
	M. CARTON SIZE (M):	0,6X0,35X0,3	
	M. CARTON SIZE (INCH):	23,62X13,78X11,81	



### DRYBAG 10L

ITEM NUMBER	EAN CODE	HS CODE	FEATURES
220019001	PCS. 8718181001182	42029291	MAX VOLUME 10 LITER 1 SHOULDER STRAP 1 HANDLE EASY-TO-CARRY KEEPS YOUR GEAR DRY FREE OF WATER & DIRT IDEAL FOR TRAVELLING
SIZE	MASTER CARTON INFO		
PCS.	QUANTITY PER M. CARTON:	10	
	M. CARTON WEIGHT (KG):	6,8	
	M. CARTON WEIGHT (LBS):	14,96	
	M. CARTON SIZE (M):	0,4X0,4X0,4	
	M. CARTON SIZE (INCH):	15,75X15,75X15,75	

**DRYBAG 20L**

<b>ITEM NUMBER</b>	<b>EAN CODE</b>	<b>HS CODE</b>	<b>FEATURES</b>
220019002	PCS. 8718181001175	42029291	20 LITER 1 SHOULDER STRAP 1 HANDLE EASY-TO-CARRY KEEPS YOUR GEAR DRY FREE OF WATER & DIRT IDEAL FOR TRAVELLING
<b>SIZE</b>	<b>MASTER CARTON INFO</b>		
PCS.	QUANTITY PER M. CARTON: 10 M. CARTON WEIGHT (KG): 6,8 M. CARTON WEIGHT (LBS): 14,96 M. CARTON SIZE (M): 0,4X0,4X0,4 M. CARTON SIZE (INCH): 15,75X15,75X15,75		

**DRYBAG 40L**

<b>ITEM NUMBER</b>	<b>EAN CODE</b>	<b>HS CODE</b>	<b>FEATURES</b>
220019003	PCS. 8718181001311	42029291	40 LITER 1 SHOULDER STRAP 1 HANDLE EASY-TO-CARRY KEEPS YOUR GEAR DRY FREE OF WATER & DIRT IDEAL FOR TRAVELLING
<b>SIZE</b>	<b>MASTER CARTON INFO</b>		
PCS.	QUANTITY PER M. CARTON: 10 M. CARTON WEIGHT (KG): 6,8 M. CARTON WEIGHT (LBS): 14,96 M. CARTON SIZE (M): 0,4X0,4X0,4 M. CARTON SIZE (INCH): 15,75X15,75X15,75		



**SUP CART**

ITEM NUMBER	EAN CODE	HS CODE	FEATURES
480019305	PCS. 8718181013895	95062900	LIGHTWEIGHT CART WITH LARGE REMOVABLE WHEELS SIDE STABILITY KICKSTAND EVA BUMPERS TO PROTECT YOUR BOARD ROLL EFFORTLESSLY BECAUSE OF THE STAINLESS STEEL BEARINGS DOWNSTRAP INCLUDED
<b>SIZE</b>	<b>MASTER CARTON INFO</b>		
PCS.	QUANTITY PER M. CARTON: 1		
	M. CARTON WEIGHT (KG): 0,01		
	M. CARTON WEIGHT (LBS): 0,022		
	M. CARTON SIZE (M): 0,63X0,29X0,16		
	M. CARTON SIZE (INCH): 24,8X11,42X6,3		



**SUP LEASH 9FT**

ITEM NUMBER	EAN CODE	HS CODE	FEATURES
480018021	PCS. 8718181252362	95062900	LENGTH 9FT (274 CM) MATERIAL: TPU KEY POCKET IN THE FOOT STRAP
SIZE	MASTER CARTON INFO		
PCS.	QUANTITY PER M. CARTON: 50	M. CARTON WEIGHT (KG): 12,5	M. CARTON WEIGHT (LBS): 27,5
	M. CARTON SIZE (M): 0,51X0,41X0,41	M. CARTON SIZE (INCH): 20,08X16,14X16,14	





### SUP LEASH COIL 10FT

ITEM NUMBER	EAN CODE	HS CODE	FEATURES
480018022	PCS. 8718181248556	95062900	LENGTH 10FT (304 CM) COILED LEASH MATERIAL: TPU KEY POCKET IN THE FOOT STRAP
SIZE	MASTER CARTON INFO		
PCS.	QUANTITY PER M. CARTON: 50 M. CARTON WEIGHT (KG): 13 M. CARTON WEIGHT (LBS): 28,6 M. CARTON SIZE (M): 0,51X0,41X0,41 M. CARTON SIZE (INCH): 20,08X16,14X16,14		



**WEBBING BUNGEE DOCK TIE**

ITEM NUMBER	EAN CODE	HS CODE	FEATURES
480018006	PCS. 8718181209137	95062900	7 FT/2.13 M MAINLINE STAINLESS STEEL HOOKS 2 FLOATS TO ATTACH YOUR BOARD TO THE DOCK
SIZE	MASTER CARTON INFO		
PCS.	QUANTITY PER M. CARTON:	20	
	M. CARTON WEIGHT (KG):	4,8	
	M. CARTON WEIGHT (LBS):	10,56	
	M. CARTON SIZE (M):	0,48 X 0,28 X 0,2	
	M. CARTON SIZE (INCH):	18,9 X 11,02 X 7,87	



### AERO CENTER SUP FIN

ITEM NUMBER	EAN CODE	HS CODE	FEATURES
480019303	PCS. 8718181007788	95062900	9" CENTER FIN FITS: ALL AERO BOARDS (EXCEPT 9.6)
SIZE	MASTER CARTON INFO		
PCS.	QUANTITY PER M. CARTON:	50	
	M. CARTON WEIGHT (KG):	113,5	
	M. CARTON WEIGHT (LBS):	249,7	
	M. CARTON SIZE (M):	0,48X0,47 X0,38	
	M. CARTON SIZE (INCH):	18,9X18,5X14,96	



### FCS TOURING SUP FIN 9"

ITEM NUMBER	EAN CODE	HS CODE	FEATURES
480019302	PCS. 8718181007771	95062900	9" TOURING CENTER FIN NO EXTRA TOOLS NEEDED TO MOUNT FITS: ALL BAMBOO AND TITAN BOARDS
SIZE	MASTER CARTON INFO		
PCS.	QUANTITY PER M. CARTON:	50	
	M. CARTON WEIGHT (KG):	113,5	
	M. CARTON WEIGHT (LBS):	249,7	
	M. CARTON SIZE (M):	0,48X0,47X0,38	
	M. CARTON SIZE (INCH):	18,9X18,5X14,96	



### FCS CENTER SUP FIN 9"

ITEM NUMBER	EAN CODE	HS CODE	FEATURES
480019301	PCS. 8718181007764	95062900	9" CENTER FIN NO EXTRA TOOLS NEEDED TO MOUNT FITS: ALL BAMBOO AND TITAN BOARDS
SIZE	MASTER CARTON INFO		
PCS.	QUANTITY PER M. CARTON:	50	
	M. CARTON WEIGHT (KG):	113,5	
	M. CARTON WEIGHT (LBS):	249,7	
	M. CARTON SIZE (M):	0,48X0,47X0,38	
	M. CARTON SIZE (INCH):	18,9X18,5X14,96	



### SUP FIN 6" SET 3 PCS.

ITEM NUMBER	EAN CODE	HS CODE	FEATURES
480019304	PCS. 8718181013888	95062900	6" STIFF FIBERGLASS CENTER FIN WITH HONEYCOMB CORE 4,5" STIFF PLASTIC SIDE FIN FITS: 9.4 BAMBOO BOARD
SIZE	MASTER CARTON INFO		
PCS.	QUANTITY PER M. CARTON:	20	
	M. CARTON WEIGHT (KG):	0,2	
	M. CARTON WEIGHT (LBS):	0,44	
	M. CARTON SIZE (M):	0,4X0,4X0,4	
	M. CARTON SIZE (INCH):	15,75X15,75X15,75	



### AERO SUP REPAIR KIT

ITEM NUMBER	EAN CODE	HS CODE	FEATURES
480017122	PCS. 8718181243865	35061000	PVC PATCH 1 TUBE OF GLUE 1 WRENCH
SIZE	MASTER CARTON INFO		
PCS.	QUANTITY PER M. CARTON:	100	
	M. CARTON WEIGHT (KG):	33	
	M. CARTON WEIGHT (LBS):	72,6	
	M. CARTON SIZE (M):	0,4X0,4X0,4	
	M. CARTON SIZE (INCH):	15,75X15,75X15,75	



**HALKEY ROBERTS VALVE**

ITEM NUMBER	EAN CODE	HS CODE	FEATURES
419918001	PCS. 8718181265874		FITS ALL AERO SUP BOARDS, MULTIRIDERS, HEAVY DUTY MULTI RIDERS AND WATERSLEDS
SIZE	MASTER CARTON INFO		
PCS.	QUANTITY PER M. CARTON: M. CARTON WEIGHT (KG): M. CARTON WEIGHT (LBS): M. CARTON SIZE (M): M. CARTON SIZE (INCH):		





**COMBO SKI**

# SIZING COMBO SKIS

## COMBO SKIS

HEMI					ALLEGRE, MODE SKI				
LENGTH	WEIGHT (KG)	WEIGHT (LBS)	BINDING SIZE (EU)	BINDING SIZE (US)	LENGTH	WEIGHT (KG)	WEIGHT (LBS)	BINDING SIZE (EU)	BINDING SIZE (US)
59"	UP TO 59	UP TO 130,1	32-40	1-6	59"	UP TO 59	UP TO 130	32-40	1-6
62"	UP TO 75	UP TO 165,3	37-45	5,5-11,5	67"	50 AND UP	110,2 AND UP	32-40	5,5-11,5
65"	50 AND UP	110,2 AND UP	37-45	5,5-11,5					

HEMI TRAINERS, BUZZ TRAINERS				
LENGTH	WEIGHT (KG)	WEIGHT (LBS)	BINDING SIZE (EU)	BINDING SIZE (US)
46"	UP TO 45	UP TO 99,2	<4,5	<36

WE ARE CONSTANTLY WORKING ON THE SIZING OF OUR PRODUCTS. CHECK OUT [JOBESPORTS.COM](https://www.jobesports.com) FOR THE MOST UP TO DATE, IMPROVED SIZING!

ALL MEASUREMENTS ARE FOR REFERENCE ONLY.



**BUZZ TRAINERS WATERSKIS**

<b>ITEM NUMBER</b>	<b>EAN CODE</b>	<b>HS CODE</b>	<b>FEATURES</b>
203419001	46 INCH 8718181001298	95062900	BEGINNER LEVEL COMBO SKIS FOR KIDS BRIGHT FINS FOR EXTRA VISIBILITY COMFORTABLE FRONT TOE AND ADJUSTABLE HEEL WOOD CONSTRUCTION INCLUDING ROPE, HANDLE AND STABILIZING BAR BINDING SIZE: USA 3-6 - EUROPE 29-36
<b>SIZE</b>	<b>MASTER CARTON INFO</b>		
46 INCH	QUANTITY PER M. CARTON: 1 M. CARTON WEIGHT (KG): 6,23 M. CARTON WEIGHT (LBS): 13,71 M. CARTON SIZE (M): 1,24X0,18X0,18 M. CARTON SIZE (INCH): 49X7X7		



**HEMI TRAINERS**

ITEM NUMBER	EAN CODE	HS CODE	FEATURES
202418002	46 INCH 8718181252225	95062900	BEGINNER LEVEL WATER SKIS FOR KIDS BRIGHT FINS FOR EXTRA VISIBILITY COMFORTABLE FRONT TOE AND ADJUSTABLE HEEL EXTRA OVERLAY FOR DURABILITY GLOSSY PROTECTIVE TOP FINISH   RIM INJECTION CONSTRUCTION WITH EXTRA METAL RODS FOR STIFFNESS. WIDE PROFILE FOR EASY STARTS   TUNNEL DESIGN FOR EASY EDGE TO EDGE AND BETTER TRACKING INCL: ROPE, HANDLE AND STABILIZER BAR ADJUSTABLE BINDING FITS SIZE: USA 3-6   EUROPE 29-36
SIZE	MASTER CARTON INFO		
46INCH	QUANTITY PER M. CARTON:	1	
	M. CARTON WEIGHT (KG):	6,49	
	M. CARTON WEIGHT (LBS):	14,28	
	M. CARTON SIZE (M):	1,22X0,22X0,14	
	M. CARTON SIZE (INCH):	48,03X8,46X5,51	



▶ TRANSPARENT COMBO SKI BAG



▶ UNIVERSAL VEST RED



▶ TRANSFER SKI COMBO RED



▶ WATERSPORT FLAG FLAME ORANGE PACK

**ALLEGRE 59" COMBO SKIS RED PACKAGE**

ITEM NUMBER	EAN CODE	HS CODE	FEATURES
208818001	59INCH 8718181256568	95062900	<p><b>SKI'S:</b> RECREATIONAL LEVEL WATER SKIS COMFORTABLE FRONT TOE AND ADJUSTABLE HEEL GLOSSY PROTECTIVE TOP FINISH. RIM INJECTION CONSTRUCTION WITH EXTRA METAL RODS FOR STIFFNESS   V BOTTOM DESIGN FOR EASY EDGE TO EDGE AND BETTER TRACKING</p> <p><b>HANDLE:</b> 12 INCH/30.48 CM WIDE HANDLE RUBBER HANDLE GRIP   60FT/18.3 M MAIN LINE</p> <p><b>VEST:</b> 50N ISO-CERTIFIED (BUOYANCY AID) LIGHTWEIGHT PE-FOAM   STRONG &amp; LIGHTWEIGHT NYLON FABRIC   ADJUSTABLE SIZING DUE TO OPEN SIDES</p>
SIZE	59INCH	MASTER CARTON INFO	
		<p>QUANTITY PER M. CARTON: 1</p> <p>M. CARTON WEIGHT (KG): 13,2</p> <p>M. CARTON WEIGHT (LBS): 29,04</p> <p>M. CARTON SIZE (M): 1,75X0,4X0,2</p> <p>M. CARTON SIZE (INCH): 68,9 X15,75 X7,87</p>	



► TRANSPARENT COMBO SKI BAG



► UNIVERSAL VEST RED



► TRANSFER SKI COMBO RED



► WATERSPORT FLAG FLAME ORANGE PACK

**ALLEGRE 67" COMBO SKIS RED PACKAGE**

ITEM NUMBER	EAN CODE	HS CODE	FEATURES
208817004	67INCH 8718181237703	95062900	<p><b>SKI'S:</b> RECREATIONAL LEVEL WATER SKIS FOR BOTH COMBO AND ENTRY-LEVEL SLALOM SKIING COMFORTABLE FRONT TOE AND ADJUSTABLE HEEL GLOSSY PROTECTIVE TOP FINISH. RIM INJECTION CONSTRUCTION WITH EXTRA METAL RODS FOR STIFFNESS   V BOTTOM DESIGN FOR EASY EDGE TO EDGE AND BETTER TRACKING</p> <p><b>HANDLE:</b> 12 INCH/30.48 CM WIDE HANDLE RUBBER HANDLE GRIP   60FT/18.3 M MAIN LINE</p> <p><b>VEST:</b> 50N ISO-CERTIFIED (BUOYANCY AID) LIGHTWEIGHT PE-FOAM   STRONG &amp; LIGHTWEIGHT NYLON FABRIC   ADJUSTABLE SIZING DUE TO OPEN SIDES</p>
SIZE	MASTER CARTON INFO		
67INCH	<p>QUANTITY PER M. CARTON: 1</p> <p>M. CARTON WEIGHT (KG): 13,2</p> <p>M. CARTON WEIGHT (LBS): 29,04</p> <p>M. CARTON SIZE (M): 1,75X0,4X0,2</p> <p>M. CARTON SIZE (INCH): 68,9X15,75X7,87</p>		



▶ TRANSPARENT COMBO SKI BAG



▶ UNIVERSAL VEST BLUE



▶ TRANSFER SKI COMBO BLUE



▶ WATERSPORT FLAG FLAME ORANGE PACK

**ALLEGRE 67" COMBO SKIS BLUE PACKAGE**

ITEM NUMBER	EAN CODE	HS CODE	FEATURES
208817006	67INCH 8718181237727	95062900	<p><b>SKI'S:</b> RECREATIONAL LEVEL WATER SKIS FOR BOTH COMBO AND ENTRY-LEVEL SLALOM SKIING COMFORTABLE FRONT TOE AND ADJUSTABLE HEEL GLOSSY PROTECTIVE TOP FINISH. RIM INJECTION CONSTRUCTION WITH EXTRA METAL RODS FOR STIFFNESS   V BOTTOM DESIGN FOR EASY EDGE TO EDGE AND BETTER TRACKING</p> <p><b>HANDLE:</b> 12 INCH/30.48 CM WIDE HANDLE RUBBER HANDLE GRIP   60FT/18.3 M MAIN LINE</p> <p><b>VEST:</b> 50N ISO-CERTIFIED (BUOYANCY AID) LIGHTWEIGHT PE-FOAM   STRONG &amp; LIGHTWEIGHT NYLON FABRIC   ADJUSTABLE SIZING DUE TO OPEN SIDES</p>
SIZE	67INCH	MASTER CARTON INFO	
		<p>QUANTITY PER M. CARTON: 1</p> <p>M. CARTON WEIGHT (KG): 13,2</p> <p>M. CARTON WEIGHT (LBS): 29,04</p> <p>M. CARTON SIZE (M): 1,75X0,4X0,2</p> <p>M. CARTON SIZE (INCH): 68,9 X15,75 X7,87</p>	



▶ TRANSPARENT COMBO SKI BAG



▶ UNIVERSAL VEST LIME GREEN



▶ TRANSFER SKI COMBO GREEN



▶ WATERSPORT FLAG FLAME ORANGE PACK

**ALLEGRE 67" COMBO SKIS LIME GREEN PACKAGE**

ITEM NUMBER	EAN CODE	HS CODE	FEATURES
208819001	PCS. 8718181015813	95062900	<p><b>SKI'S:</b> RECREATIONAL LEVEL WATER SKIS FOR BOTH COMBO AND ENTRY-LEVEL SLALOM SKIING COMFORTABLE FRONT TOE AND ADJUSTABLE HEEL GLOSSY PROTECTIVE TOP FINISH. RIM INJECTION CONSTRUCTION WITH EXTRA METAL RODS FOR STIFFNESS   V BOTTOM DESIGN FOR EASY EDGE TO EDGE AND BETTER TRACKING</p> <p><b>HANDLE:</b> 12 INCH/30.48 CM WIDE HANDLE RUBBER HANDLE GRIP   60FT/18.3 M MAIN LINE</p> <p><b>VEST:</b> 50N ISO-CERTIFIED (BUOYANCY AID) LIGHTWEIGHT PE-FOAM   STRONG &amp; LIGHTWEIGHT NYLON FABRIC   ADJUSTABLE SIZING DUE TO OPEN SIDES</p>
SIZE	PCS.	MASTER CARTON INFO	
		<p>QUANTITY PER M. CARTON: 1</p> <p>M. CARTON WEIGHT (KG): 13,2</p> <p>M. CARTON WEIGHT (LBS): 29,04</p> <p>M. CARTON SIZE (M): 1,75X0,4X0,2</p> <p>M. CARTON SIZE (INCH): 68,9X15,75X7,87</p>	







**ALLEGRE COMBO SKIS RED**

ITEM NUMBER	EAN CODE	HS CODE	FEATURES
203318003	59 INCH 8718181244732 67 INCH 8718181244749	95062900	RECREATIONAL LEVEL WATER SKIS FOR BOTH COMBO AND ENTRY-LEVEL SLALOM SKIING BRIGHT FINS FOR EXTRA VISIBILITY COMFORTABLE FRONT TOE AND ADJUSTABLE HEEL EXTRA MOLDED OVERLAY STRAP FOR DURABILITY EXTRA SLALOM TOE GLOSSY PROTECTIVE TOP FINISH RIM INJECTION CONSTRUCTION WITH EXTRA METAL RODS FOR STIFFNESS   V BOTTOM DESIGN FOR EASY EDGE TO EDGE AND BETTER TRACKING BINDING SIZE: USA -6-14   EUROPE 36-47 WEIGHT RANGE : 59" < 55KG
<b>SIZE</b>		<b>MASTER CARTON INFO</b>	
59INCH   67INCH		QUANTITY PER M. CARTON: 1 M. CARTON WEIGHT (KG): 8,36 M. CARTON WEIGHT (LBS): 18,39 M. CARTON SIZE (M): 1,51X 0,19 X 0,16 M. CARTON SIZE (INCH): 59,45 X 7,48 X 6,3	



### ALLEGRE COMBO SKIS BLUE

ITEM NUMBER	EAN CODE	HS CODE	FEATURES
203318001	67 INCH 8718181244718	95062900	RECREATIONAL LEVEL WATER SKIS FOR BOTH COMBO AND ENTRY-LEVEL SLALOM SKIING BRIGHT FINS FOR EXTRA VISIBILITY COMFORTABLE FRONT TOE AND ADJUSTABLE HEEL EXTRA MOLDED OVERLAY STRAP FOR DURABILITY. EXTRA SLALOM TOE GLOSSY PROTECTIVE TOP FINISH. RIM INJECTION CONSTRUCTION WITH EXTRA METAL RODS FOR STIFFNESS   V BOTTOM DESIGN FOR EASY EDGE TO EDGE AND BETTER TRACKING BINDING SIZE: USA -6-14   EUROPE 36-47 WEIGHT RANGE : 67" >50KG
<b>SIZE</b>		<b>MASTER CARTON INFO</b>	
67INCH		QUANTITY PER M. CARTON: 1 M. CARTON WEIGHT (KG): 10,12 M. CARTON WEIGHT (LBS): 22,26 M. CARTON SIZE (M): 1,72X0,2X0,18 M. CARTON SIZE (INCH): 67,72X7,68X6,95	



JOBESPORTS.COM | PAGE 316

**ALLEGRE COMBO SKIS LIME GREEN**

ITEM NUMBER	EAN CODE	HS CODE	FEATURES
203319001	67INCH 8718181015769	95062900	RECREATIONAL LEVEL WATER SKIS FOR BOTH COMBO AND ENTRY-LEVEL SLALOM SKIING BRIGHT FINS FOR EXTRA VISIBILITY COMFORTABLE FRONT TOE AND ADJUSTABLE HEEL EXTRA MOLDED OVERLAY STRAP FOR DURABILITY EXTRA SLALOM TOE   GLOSSY PROTECTIVE TOP FINISH RIM INJECTION CONSTRUCTION WITH EXTRA METAL RODS FOR STIFFNESS. V BOTTOM DESIGN FOR EASY EDGE TO EDGE AND BETTER TRACKING BINDING SIZE: USA -6-14   EUROPE 36-47 WEIGHT RANGE : 67" >50KG
<b>SIZE</b>	<b>MASTER CARTON INFO</b>		
67INCH	QUANTITY PER M. CARTON: 1 M. CARTON WEIGHT (KG): 10,12 M. CARTON WEIGHT (LBS): 22,264 M. CARTON SIZE (M): 1,72X0,2X0,18 M. CARTON SIZE (INCH): 67,72X7,68X6,95		



## HEMI COMBO SKIS

ITEM NUMBER	EAN CODE	HS CODE	FEATURES
202418001	59 INCH 8718181248792 65 INCH 8718181248815	95062900	BEGINNER LEVEL WATER SKIS FOR KIDS BRIGHT FINS FOR EXTRA VISIBILITY COMFORTABLE FRONT TOE AND ADJUSTABLE HEEL EXTRA MOLDED OVERLAY STRAP FOR DURABILITY EXTRA SLALOM TOE GLOSSY PROTECTIVE TOP FINISH   RIM INJECTION CONSTRUCTION WITH EXTRA METAL RODS FOR STIFFNESS   WIDE PROFILE FOR EASY STARTS TUNNEL DESIGN FOR EASY EDGE TO EDGE AND BETTER TRACKING ADJUSTABLE BINDING FITS SIZE : USA 6-14   EUROPE 36-47 WEIGHT RANGE : 59" < 55KG
<b>SIZE</b>	<b>MASTER CARTON INFO 59"</b>	<b>MASTER CARTON INFO 65"</b>	
59INCH   65INCH	QUANTITY PER M. CARTON: 1 M. CARTON WEIGHT (KG): 8,36 M. CARTON WEIGHT (LBS): 18,39 M. CARTON SIZE (M): 1,51X0,19X0,16 M. CARTON SIZE (INCH): 59,45X7,48X6,3	QUANTITY PER M. CARTON: 1 M. CARTON WEIGHT (KG): 9,35 M. CARTON WEIGHT (LBS): 20,61 M. CARTON SIZE (M): 1,70X0,21X0,22 M. CARTON SIZE (INCH): 66,93X8,26X8,66	



**MODE COMBO SKIS**

ITEM NUMBER	EAN CODE	HS CODE	FEATURES
203219001	67 INCH 8718181013727	95062900	SPORT LEVEL WATERSKIS   BRIGHT SLALOM SKI ALUMINIUM FIN FOR EXTRA VISIBILITY COMFORTABLE AND SUPPORTIVE RUBBER FIXED BINDING EXTRA SLALOM TOE GLOSSY PROTECTIVE TOP FINISH RIM INJECTION CONSTRUCTION WITH EXTRA METAL RODS FOR STIFFNESS V BOTTOM DESIGN FOR EASY EDGE TO EDGE AND BETTER TRACKING BINDING SIZE: USA -6-14   EUROPE 36-47 WEIGHT RANGE: 67" > 50KG
SIZE	MASTER CARTON INFO		
67 INCH	QUANTITY PER M. CARTON:	1	
	M. CARTON WEIGHT (KG):	10,12	
	M. CARTON WEIGHT (LBS):	22,26	
	M. CARTON SIZE (M):	1,74 X 0,41 X 0,21	
	M. CARTON SIZE (INCH):	68,31 X 16,14 X 8,07	



### COMBO WATERSKIS BAG

ITEM NUMBER	EAN CODE	HS CODE	FEATURES
221219001	PCS. 8718181013772	42029291	SUPER STRONG 600D NYLON 122X41X20 CM FITS ALL JOBE SKI SIZES SUPER STRONG 600D NYLON EASY-TO-CARRY COMFORTABLE STRAPS
SIZE	MASTER CARTON INFO		
PCS.	QUANTITY PER M. CARTON:	15	
	M. CARTON WEIGHT (KG):	0,15	
	M. CARTON WEIGHT (LBS):	0,33	
	M. CARTON SIZE (M):	0,62X0,34X0,59	
	M. CARTON SIZE (INCH):	24,41X13,39X23,23	

**PARTS**



**SQUEEZE HEEL TRAINER**

▶ 350801010



**FRONT TOE TRAINER**

▶ 350801009



**FIN TRAINER LOW INCL. SCREWS**

▶ 350804002



**FIN TRAINER HIGH INCL. SCREWS**

▶ 350210001



**SQUEEZE HEEL JUNIOR**

▶ 350801008



**FRONT TOE JUNIOR**

▶ 350801007



**SLALOM TOE JUNIOR**

▶ 350804001



**SQUEEZE HEEL ADULT**

▶ 350800006



**FRONT TOE ADULT**

▶ 350800005



**SLALOM TOE ADULT**

▶ 350800001

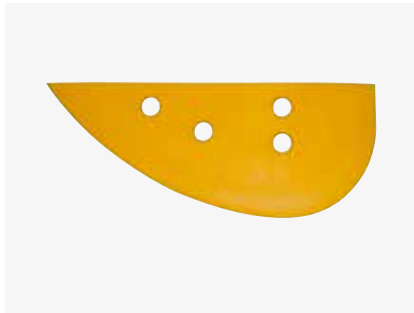

**COMBO FIN**

▶ 350803002



**STABILIZING BAR STANDARD**

▶ 200805002



**STABILIZING BAR JUNIOR**

▶ 200805003





**SLALOM SKI**

# SIZING SLALOM SKIS

## SLALOM SKIS

	BARON	MODE
ADVANCED	X	-
INTERMEDIATE	X	X
ENTRANCE	X	X

## TRADITIONAL SLALOM SKIS JOBE

	67" (KG)	67" (LBS)	69" (KG)	69" (LBS)
28-30 MPH / 46-49 KMH	54-64	119-141,1	64-73	141,1-161
30-32 MPH / 40-52 KMH	64-73	141,1-161	73-82	161-180,8
32-34 MPH / 52-55 KMH	73-82	161-180,8	82-91	180,8-200,6
34-36 MPH / 55-58 KMH	82-91	180,8-200,6	91-100	200,6-220,5

## SLALOM SKI BINDINGS

FOCUS	STANDARD	XLARGE	
US	6,5-8,5	09-14	
	38,5-42	43-48	
COMFORT	5-8	8-11	11-14
	35-39	40-44	45 - 48,5
	STANDARD		
DIRECT	5-12		
	35-47		

WE ARE CONSTANTLY WORKING ON THE SIZING OF OUR PRODUCTS. CHECK OUT [JOBESPORTS.COM](https://www.jobesports.com) FOR THE MOST UP TO DATE, IMPROVED SIZING!

ALL MEASUREMENTS ARE FOR REFERENCE ONLY.





**MODE SLALOM SKI**

<i>ITEM NUMBER</i>	<i>EAN CODE</i>	<i>HS CODE</i>	<i>FEATURES</i>
262519001	67 INCH 8718181003476	95062900	SPORT LEVEL SLALOM SKI BRIGHT SLALOM SKI ALUMINIUM FIN FOR EXTRA VISIBILITY COMFORTABLE RUBBER FIXED BINDING EXTRA SLALOM TOE GLOSSY PROTECTIVE TOP FINISH RIM INJECTION CONSTRUCTION WITH EXTRA METAL RODS FOR STIFFNESS. V BOTTOM DESIGN FOR EASY EDGE TO EDGE AND BETTER TRACKING
<b>SIZE</b>		<b>MASTER CARTON INFO</b>	
67 INCH		QUANTITY PER M. CARTON: 1 M. CARTON WEIGHT (KG): 5,53 M. CARTON WEIGHT (LBS): 12,166 M. CARTON SIZE (M): 1,74X0,22X0,22 M. CARTON SIZE (INCH): 68,31X8,46X8,46	BINDING SIZE USA -6-14 EUROPE 36-47



**BARON SLALOM SKI**

**ITEM NUMBER**

262319001

**EAN CODE**

67 INCH 8718181003452  
69 INCH 8718181003469

**HS CODE**

95062900

**FEATURES**

3-STAGE ROCKER  
EDGE-TO-EDGE CONCAVE FOR A BETTER TRACTION  
FOAM CORE  
STANDARD ALUMINIUM SLALOM FIN  
HIGH PRESS FIBERGLASS MOLDED

**SIZE**

67 INCH | 69 INCH

**MASTER CARTON INFO**

QUANTITY PER M. CARTON: 1  
M. CARTON WEIGHT (KG): 3,35  
M. CARTON WEIGHT (LBS): 7,37  
M. CARTON SIZE (M): 1,74X0,19X0,19  
M. CARTON SIZE (INCH): 68,5X7,48X7,48



### FOCUS SLALOM BINDING

ITEM NUMBER	EAN CODE	HS CODE	FEATURES
333116003	XL 8718181198479 STAND 8718181198462	95062900	NYLON PLASTIC BASE PLATE INNER LINER FOR PRO-LEVEL SUPPORT DUAL LACES SOFT HEEL PADS FOR PROPER FOOT PLACEMENT FLEX PANELS ON DIFFERENT AREAS SOFT ERGONOMIC SHAPED FOOT BED
SIZE	MASTER CARTON INFO		
XL   STAND	QUANTITY PER M. CARTON: 6 M. CARTON WEIGHT (KG): 9,9 M. CARTON WEIGHT (LBS): 21,83 M. CARTON SIZE (M): 0,53X0,35X0,47 M. CARTON SIZE (INCH): 20,86X13,78X18,50		SIZE: US - EUROPE STAND: 6,5/8,5 - 38,5/42 XL: 9/14 - 43/48



**COMFORT SLALOM BINDING**

ITEM NUMBER	EAN CODE	HS CODE	FEATURES
333113001	5/8 8718181120470 8/11 8718181120487 11/14 8718181120494	95062900	ALUMINIUM LOW PROFILE BASE PLATE INNER LINER FOR PRO-LEVEL SUPPORT DUAL LACES SOFT HEEL PADS FOR PROPER FOOT PLACEMENT FLEX PANELS ON DIFFERENT AREAS SOFT ERGONOMIC SHAPED FOOT BED
<b>SIZE</b>		<b>MASTER CARTON INFO</b>	
5/8   8/11   11/14		QUANTITY PER M. CARTON: 6 M. CARTON WEIGHT (KG): 9,9 M. CARTON WEIGHT (LBS): 21,78 M. CARTON SIZE (M): 0,53X0,43X0,55 M. CARTON SIZE (INCH): 20,87X16,93X21,46	SIZE: US - EUROPE 5/8 - 35-39 8/11 - 40-44 11/14 - 45-48,5



### RTP ADJUSTABLE NYLON

ITEM NUMBER	EAN CODE	HS CODE	FEATURES
333116002	STAND 8718181197328	95062900	STRONG NYLON PLATE SOFT ERGONOMIC SHAPED FOOT BED
SIZE	MASTER CARTON INFO		
STAND	QUANTITY PER M. CARTON: 20 M. CARTON WEIGHT (KG): 15,4 M. CARTON WEIGHT (LBS): 133,95 M. CARTON SIZE (M): 0,75X0,41X0,38 M. CARTON SIZE (INCH): 29,52X16,14X14,96		



**RTP ALUMINIUM**

<i>ITEM NUMBER</i>	<i>EAN CODE</i>	<i>HS CODE</i>	<i>FEATURES</i>
330016001	XL 8718181189804 MINI 8718181189781 STAND 8718181189798	95062900	ALUMINIUM LOW PROFILE BASE PLATE SOFT ERGONOMIC SHAPED FOOT BED
<b>SIZE</b>		<b>MASTER CARTON INFO</b>	
XL   MINI   STAND		QUANTITY PER M. CARTON: 20 M. CARTON WEIGHT (KG): 16,2 M. CARTON WEIGHT (LBS): 35,64 M. CARTON SIZE (M): 0,76X0,42X0,55 M. CARTON SIZE (INCH): 29,72X16,54X21,46	





### NEOPRENE SLALOM BAG

ITEM NUMBER	EAN CODE	HS CODE	FEATURES
221117001	PCS. 8718181209526	42029900	2.5 MM NEOPRENE BAG 145X20 CM SUITABLE FOR ALL JOBE SKIS TIE-DOWN STRAPS
SIZE	MASTER CARTON INFO		
PCS.	QUANTITY PER M. CARTON:	10	
	M. CARTON WEIGHT (KG):	4,4	
	M. CARTON WEIGHT (LBS):	9,68	
	M. CARTON SIZE (M):	0,48X0,46X0,23	
	M. CARTON SIZE (INCH):	19X18X9	



**PADDED SLALOM BAG**

ITEM NUMBER	EAN CODE	HS CODE	FEATURES
221119001	PCS. 8718181013765	42029291	SUPER STRONG 600D NYLON 180X23X25 CM PADDED THROUGHOUT THE ENTIRE BOTTOM EASY-TO-CARRY COMFORTABLE SHOULDER STRAPS
SIZE	MASTER CARTON INFO		
PCS.	QUANTITY PER M. CARTON: 10	M. CARTON WEIGHT (KG): 0,1	
	M. CARTON WEIGHT (LBS): 0,22	M. CARTON SIZE (M): 0,67 X 0,32 X 0,39	
	M. CARTON SIZE (INCH): 26,38 X 12,6 X 15,35		





**TRANSFER SKI COMBO BLUE**

ITEM NUMBER	EAN CODE	HS CODE	FEATURES
211217006	PCS. 8718181209236	95062900	12 INCH/30.48 CM WIDE HANDLE 28MM THICK ROUND GRIP RUBBER HANDLE GRIP
<b>SIZE</b>	<b>MASTER CARTON INFO</b>		
PCS.	QUANTITY PER M. CARTON: 12 M. CARTON WEIGHT (KG): 8,16 M. CARTON WEIGHT (LBS): 17,952 M. CARTON SIZE (M): 0,45X0,33X0,34 M. CARTON SIZE (INCH): 11,72X12,8X13,39		12 STRAND MAIN LINE 60FT/18.28 M MAIN LINE TRADITIONAL WATERSKI ROPE AND HANDLE



**TRANSFER SKI COMBO RED**

ITEM NUMBER	EAN CODE	HS CODE	FEATURES
211217004	PCS. 8718181209199	95062900	12 INCH/30.48 CM WIDE HANDLE 28MM THICK ROUND GRIP RUBBER HANDLE GRIP
<b>SIZE</b>	<b>MASTER CARTON INFO</b>		
PCS.	QUANTITY PER M. CARTON: 12 M. CARTON WEIGHT (KG): 8,04 M. CARTON WEIGHT (LBS): 17,688 M. CARTON SIZE (M): 0,45X0,33X0,34 M. CARTON SIZE (INCH): 11,72X12,8X13,39		12 STRAND MAIN LINE 60FT/18.28 M MAIN LINE TRADITIONAL WATERSKI ROPE AND HANDLE



**TRANSFER SKI COMBO GREEN**

ITEM NUMBER	EAN CODE	HS CODE	FEATURES
211217005	PCS. 8718181209212	95062900	12 INCH/30.48 CM WIDE HANDLE 28MM THICK ROUND GRIP RUBBER HANDLE GRIP 12 STRAND MAIN LINE 60FT/18.28 M MAIN LINE TRADITIONAL WATERSKI ROPE AND HANDLE
<b>SIZE</b>		<b>MASTER CARTON INFO</b>	
PCS.		QUANTITY PER M. CARTON:	12
		M. CARTON WEIGHT (KG):	8,04
		M. CARTON WEIGHT (LBS):	17,688
		M. CARTON SIZE (M):	0,45X0,33X0,34
		M. CARTON SIZE (INCH):	11,72X12,8X13,39



**SPORT SERIES 2 SECTION**

ITEM NUMBER	EAN CODE	HS CODE	FEATURES
211117025	PCS. 8718181208840	95062900	12INCH/30.48 CM WIDE HANDLE 28MM THICK ROUND GRIP RUBBER PROFILED HANDLE GRIP 75FT/22.86 M MAIN LINE WITH 2 EXTENSIONS
<b>SIZE</b>	<b>MASTER CARTON INFO</b>		
PCS.	QUANTITY PER M. CARTON: 16		
	M. CARTON WEIGHT (KG): 12,64		
	M. CARTON WEIGHT (LBS): 27,808		
	M. CARTON SIZE (M): 0,48X0,32X0,52		
	M. CARTON SIZE (INCH): 18,9X12,6X20,47		



**SPORT SERIES 8 SECTION**

ITEM NUMBER	EAN CODE	HS CODE	FEATURES
211117026	PCS. 8718181208826	95062900	12 INCH/30.48 CM WIDE HANDLE 28MM THICK ROUND GRIP RUBBER PROFILED HANDLE GRIP
<b>SIZE</b>	<b>MASTER CARTON INFO</b>		
PCS.	QUANTITY PER M. CARTON: 16 M. CARTON WEIGHT (KG): 13,76 M. CARTON WEIGHT (LBS): 30,272 M. CARTON SIZE (M): 0,65X0,48X0,32 M. CARTON SIZE (INCH): 25,59X18,9X12,6		75FT/22.86 M MAIN LINE WITH 8 EXTENSIONS SUITABLE FOR WATERSKI AND SLALOMSKIING





**15" EASY UP DEEP V DELUXE**

ITEM NUMBER	EAN CODE	HS CODE	FEATURES
211217001	PCS. 8718181208932	95062900	15 INCH/38.1 CM WIDE HANDLE 27,4MM THICK ROUND GRIP EVA PROFILED HANDLE GRIP
<b>SIZE</b>	<b>MASTER CARTON INFO</b>		
PCS.	QUANTITY PER M. CARTON: 16 M. CARTON WEIGHT (KG): 14,72 M. CARTON WEIGHT (LBS): 32,384 M. CARTON SIZE (M): 0,58X0,4X0,43 M. CARTON SIZE (INCH): 22,83X1,575X1,693		16 STRAND MAIN-LINE 70FT/21.33 M MAIN LINE EXTRA V-HANDLE FOR EASY STARTS PENCIL FLOATS TO SUPPORT FLOATATION MAKES STARTING EASIER WITH A SLALOM SKI



**WATERSPORTS BRIDLE WITHOUT PULLEY 8FT 2P**

ITEM NUMBER	EAN CODE	HS CODE	FEATURES
210017031	PCS. 8718181209038	56090000	MAXIMUM PULL 2 PERSONS LENGTH 8FT/2.43 M. 2 STAINLESS STEEL HOOKS TO CONNECT WITH YOUR BOAT. FLOAT TO KEEP THE ROPE AWAY FROM PROPELLOR MAX BREAK STRENGTH 2375 LBS./1077 KG
<b>SIZE</b>	<b>MASTER CARTON INFO</b>		
PCS.	QUANTITY PER M. CARTON: 12 M. CARTON WEIGHT (KG): 4,68 M. CARTON WEIGHT (LBS): 10,296 M. CARTON SIZE (M): 0,34X0,22X0,2 M. CARTON SIZE (INCH): 13,39X8,66X7,87		



**ROPE BRIDLE STAINLESS HOOKS 12FT 1P**

ITEM NUMBER	EAN CODE	HS CODE	FEATURES
210017029	PCS. 8718181208994	56090000	MAXIMUM PULL 1 PERSON. LENGTH 12FT/3.65 M. 2 STAINLESS STEEL HOOKS TO CONNECT WITH YOUR BOAT. FLOAT TO KEEP THE ROPE AWAY FROM PROP MAX BREAK STRENGTH 1170LBS/530 KG
<b>SIZE</b>		<b>MASTER CARTON INFO</b>	
PCS.		QUANTITY PER M. CARTON: 12 M. CARTON WEIGHT (KG): 6 M. CARTON WEIGHT (LBS): 13,2 M. CARTON SIZE (M): 0,55X0,33X0,25 M. CARTON SIZE (INCH): 21,65X12,99X9,84	



**WATERSPORTS BRIDLE WITH PULLEY 12FT 2P**

ITEM NUMBER	EAN CODE	HS CODE	FEATURES
210017032	PCS. 8718181209052	56090000	MAXIMUM PULL 2 PERSONS LENGTH 12FT/3.65 M. 2 STAINLESS STEEL HOOKS TO CONNECT WITH YOUR BOAT. FLOAT TO KEEP THE ROPE AWAY FROM PROPELLOR MAX BREAK STRENGTH 2375 LBS./1077 KG
<b>SIZE</b>	<b>MASTER CARTON INFO</b>		
PCS.	QUANTITY PER M. CARTON: 12 M. CARTON WEIGHT (KG): 6 M. CARTON WEIGHT (LBS): 13,2 M. CARTON SIZE (M): 0,34X0,31X0,24 M. CARTON SIZE (INCH): 13,39X12,01X9,45		



**CABLE BRIDLE STAINLESS HOOKS 8FT 1P**

ITEM NUMBER	EAN CODE	HS CODE	FEATURES
210017030	PCS. 8718181209014	95062900	MAXIMUM PULL 1 PERSON LENGTH 8FT/2.43 M. 2 STAINLESS STEEL HOOKS TO CONNECT WITH YOUR BOAT. FLOAT TO KEEP THE ROPE AWAY FROM PROPELLOR MAX BREAK STRENGTH 1170LBS/530 KG
<b>SIZE</b>	<b>MASTER CARTON INFO</b>		
PCS.	QUANTITY PER M. CARTON: 12		
	M. CARTON WEIGHT (KG): 8,88		
	M. CARTON WEIGHT (LBS): 19,536		
	M. CARTON SIZE (M): 0,55X0,33X0,28		
	M. CARTON SIZE (INCH): 21,65 X12,99 X11,02		



**SKI FLAG FLAME ORANGE**

ITEM NUMBER	EAN CODE	HS CODE	FEATURES
210305001	PCS. 8718181000949	63079098	BRIGHT COLORED FLAG THAT SERVES AS A WARNING
<b>SIZE</b>	<b>MASTER CARTON INFO</b>		
PCS.	QUANTITY PER M. CARTON: 100 M. CARTON WEIGHT (KG): 6 M. CARTON WEIGHT (LBS): 13,2 M. CARTON SIZE (M): 0,53X0,33X0,15 M. CARTON SIZE (INCH): 21X13X6		



**WAKEBOARD**

# FOAM CORE TECHNOLOGY

BINDING INSERT PACK:  
FITS ALL WAKEBOARD BINDINGS

TRIAxIAL LAYUP:  
PERFECT STRENGTH AND FLEX

TPU TOPSHEET:  
HIGH QUALITY GRAPHIC

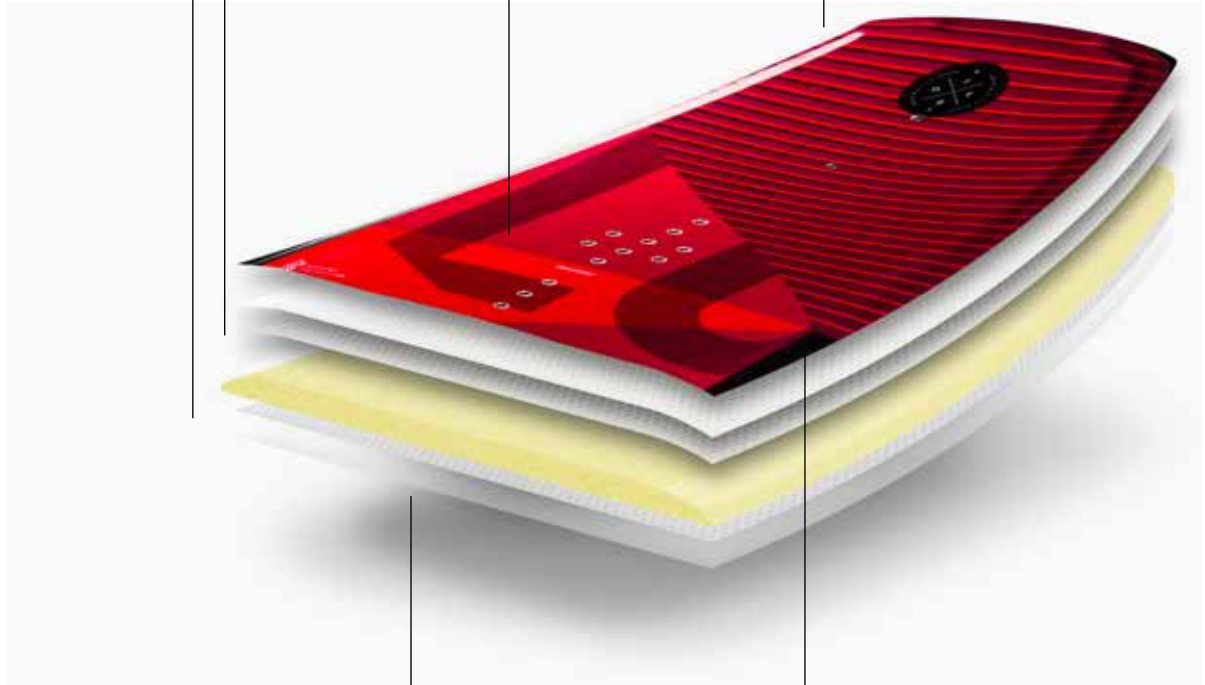

HIGHT IMPACT  
BOTTOM LAYER:  
HIGH QUALITY GRAPHIC

FOAM CORE  
LESS  
WEIGHT AND  
DURABLE



# BLENDING CORE TECHNOLOGY

---

BINDING INSERT PACK:  
FITS ALL WAKEBOARD BINDINGS

TPU TOPSHEET:  
HIGH QUALITY GRAPHIC

TRIAxIAL LAYUP:  
PERFECT STRENGTH AND FLEX

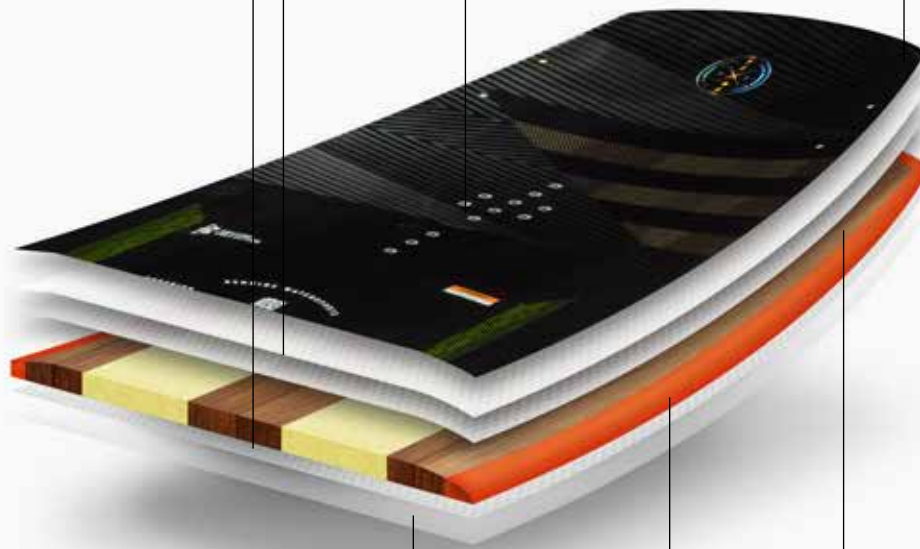

FOAM/WOOD CORE

ABS SIDE WALLS

HIGH IMPACT BOTTOM LAYER:  
HIGH QUALITY GRAPHIC

# NATURE CORE TECHNOLOGY

---

BINDING INSERT PACK:  
FITS ALL WAKEBOARD BINDINGS

TRIAxIAL LAYUP:  
PERFECT STRENGTH AND FLEX

TPU TOPSHEET:  
HIGH QUALITY GRAPHIC

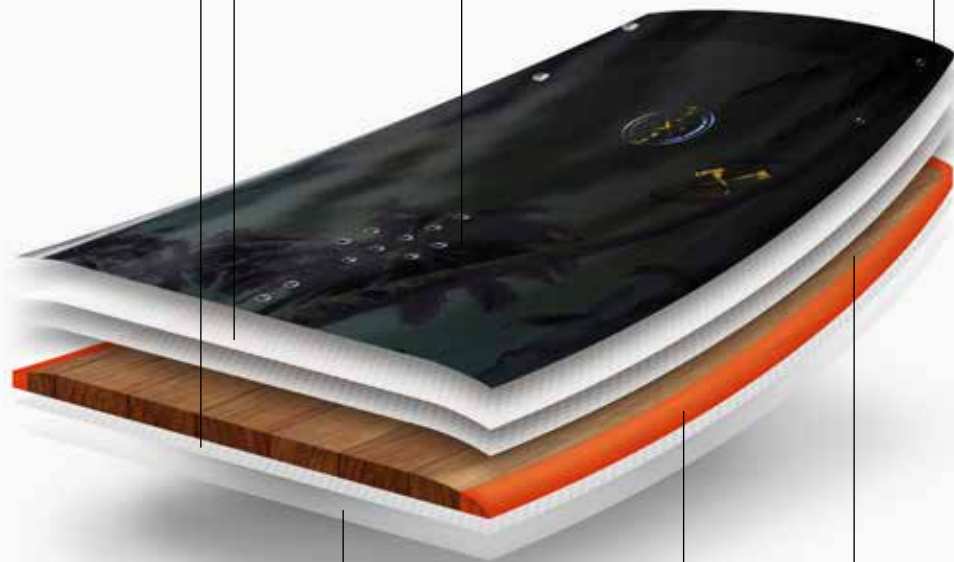

WOOD CORE

ABS SIDE WALLS

HIGH IMPACT BOTTOM LAYER:  
HIGH QUALITY GRAPHIC

# SIZING WAKEBOARD & BINDINGS

## WAKEBOARDS

	KNOX	KNOX	MADDOX	MADDOX	PROLIX	PROLIX
LENGTH	143 CM   56,3"	139 CM   54,7"	142 CM   55,9"	138 CM   54,3"	138 CM   54,3"	143 CM   56,3"
INSERT SETUP	6" +DRIFT SETUP	6" +DRIFT SETUP	6" +DRIFT SETUP	6" +DRIFT SETUP	6" +DRIFT SETUP	6" +DRIFT SETUP
TIP/TAIL WIDTH	30,6 CM   12"	29,6 CM   11,7"	30,6 CM   12"	29,6 CM   11,7"	27,25 CM   10,7"	28 CM   11"
CENTER WIDTH	44 CM   17,3"	44 CM   17,3"	42,5 CM   16,7"	41,5 CM   16,3"	41,8 CM   16,5"	42,5 CM   16,7"
ROCKER + HEIGHT	2,9/3-STAGE	2,9/3-STAGE	2,8/3-STAGE	2,8/3-STAGE	2,7/HYBRID	2,8/HYBRID
BOARD LEVEL	INT./ADVANCED	INT./ADVANCED	INT./ADVANCED	INT./ADVANCED	INT./ADVANCED	INT./ADVANCED
RIDER WEIGHT KG	80 AND UP	70 - 100	80 AND UP	70 - 100	64 - 94	75 AND UP
RIDER WEIGHT LBS	176,4 AND UP	154,3 - 220,5	176,4 AND UP	154,3 - 220,5	141,1 - 207,2	165,3 AND UP

	VANITY - MEN/LADIES	VANITY - MEN/LADIES	VANITY - MEN	LOGO	JINX	RELOAD	RELOAD
LENGTH	131 CM   51,6"	136 CM   53,5"	141 CM   55,5"	138 CM   54,3"	128 CM   50,4"	147 CM   57,9"	144 CM   56,7"
INSERT SETUP	6" +DRIFT SETUP	6" +DRIFT SETUP	6" +DRIFT SETUP	6" +DRIFT SETUP	6"	6" +DRIFT SETUP	6" +DRIFT SETUP
TIP/TAIL WIDTH	24,8 CM   9,8"	25,4 CM   10"	25,9 CM   10,2"	27,25 CM   10,7"	27,25 CM   10,7"	32 CM   12,6"	28 CM   11"
CENTER WIDTH	39,9 CM   15,7"	40,4 CM   15,9"	40,9 CM   16,1"	41,8 CM   16,5"	38 CM   15"	43,5 CM   17,1"	43,5 CM   17,1"
ROCKER + HEIGHT	2,6/CONTINUOUS	2,7/CONTINUOUS	2,8/CONTINUOUS	2,7/3-STAGE	2,5/3-STAGE	2,9/3-STAGE	2,8/3-STAGE
BOARD LEVEL	ALL	ALL	ALL	ALL	ALL	ADVANCED	ADVANCED
RIDER WEIGHT KG	31 - 67	45 - 81	63 - 103	64 - 94	23 - 55	75 AND UP	59 - 90
RIDER WEIGHT LBS	68,3 - 147,7	99,2 - 178,6	138,9 - 227,1	141,1 - 207,2	50,7 - 121,3	165,3 AND UP	130,1 - 198,4

	PITCH	PITCH	CONFLICT	CONFLICT	CONFLICT	CONFLICT	CONFLICT
LENGTH	144 CM   56,7"	140 CM   55,1"	145 CM   57,1"	142 CM   55,9"	138 CM   54,3"	134 CM   52,8"	127 CM   50"
INSERT SETUP	6" +DRIFT SETUP	6" +DRIFT SETUP	6" +DRIFT SETUP	6" +DRIFT SETUP	6" +DRIFT SETUP	6" +DRIFT SETUP	6" +DRIFT SETUP
TIP/TAIL WIDTH	29,7 CM   11,7"	29 CM   11,4"	31,7 CM   12,5"	31,7 CM   12,5"	30,5 CM   12"	30,3 CM   11,9"	28,5 CM   11,2"
CENTER WIDTH	44,3 CM   17,4"	43,2 CM   17"	43 CM   16,9"	43 CM   16,9"	42,1 CM   16,6"	41,3 CM   16,3"	38,9 CM   15,3"
ROCKER + HEIGHT	2,8/CONTINUOUS	2,7/CONTINUOUS	2,6/CONTINUOUS	2,95/3-STAGE	2,7-STAGE	2,6/3-STAGE	2,3/3-STAGE
BOARD LEVEL	ADVANCED	ADVANCED	ADVANCED	ADVANCED	ADVANCED	ADVANCED	ADVANCED
RIDER WEIGHT KG	75 AND UP	59 - 90	80 AND UP	75 AND UP	59 - 90	41 - 77	23 - 55
RIDER WEIGHT LBS	165,3 AND UP	130,1 - 198,4	176,4 AND UP	165,3 AND UP	130,1 - 198,4	90,4 - 169,8	50,7 - 121,3

	CONCORD	CONCORD	CONCORD	ARMADA
LENGTH	145 CM   57,1"	141 CM   55,5"	137   53,9"	137 CM   53,9"
INSERT SETUP	6" +DRIFT SETUP	6" +DRIFT SETUP	6" +DRIFT SETUP	6" +DRIFT SETUP
TIP/TAIL WIDTH	32 CM   12,6"	31 CM   12,2"	30 CM   11,8"	30 CM   11,8"
CENTER WIDTH	44 CM   17,3"	43 CM   16,9"	42 CM   16,5"	42 CM   16,5"
ROCKER + HEIGHT	2,8/HYBRID	2,8/HYBRID	2,6/HYBRID	2,6/HYBRID
BOARD LEVEL	ADVANCED	ADVANCED	ADVANCED	ADVANCED
RIDER WEIGHT KG	80 AND UP	75 AND UP	60-94	60-94
RIDER WEIGHT LBS	176,4 AND UP	165,3 AND UP	132,2 - 207,2	132,2 - 207,2

## WAKEBOARD BINDINGS

	6	7	8	9	10	11
DRIFT SNEAKER US						
DRIFT SNEAKER EU	38	39-40	41-42	43	44	45-46
HOST/REPUBLIK/UNIT	US 3-6 / EU 35-39		US 7-10 / EU 40-44		US 10-12 / EU 44-47	
MAZE	-		US 7-11 / EU 40-46		-	
NITRO	US 7-8 / EU 40-41		US 8-9,5 / EU 42-43		US 10-11 / EU 44-45	

## JINX WAKEBOARD BINDING

US	3-7
EU	33-39

## DRIFT WAKEBOARD BINDING MIX AND MATCH SIZES

SNEAKERS	DRIFT SNEAKER 6-7	DRIFT SNEAKER 8-9	DRIFT SNEAKER MEN 10-11
BINDING	M	M	L
SKINS	S	M	L

WE ARE CONSTANTLY WORKING ON THE SIZING OF OUR PRODUCTS. CHECK OUT [JOBESPORTS.COM](http://JOBESPORTS.COM) FOR THE MOST UP TO DATE, IMPROVED SIZING!

ALL MEASUREMENTS ARE FOR REFERENCE ONLY.



▶ TRANSPARENT WAKEBOARD BAG 130



▶ JUNIOR WAKEBOARD BINDINGS



▶ WAKE COMBO PRIME BLUE

**JINX WAKEBOARD PACKAGE 128**

ITEM NUMBER	EAN CODE	HS CODE	FEATURES
278819087	128 8718181018821	95062900	<p><b>BOARD:</b> 128 CM                      INJECTION FOAM CORE   FIBERGLASS REINFORCED                      CONTINUOUS ROCKER                      DOUBLE CONCAVE BOTTOM DESIGN FOR SMOOTH LANDINGS                      2 NYLON PLASTIC CENTER FINES                      BASE BOARD: EVERYTHING YOU NEED FOR AWESOMESS (FOR A GREAT PRICE)  <b>BINDINGS:</b> US3/7 - EU33-40  <b>HANDLE:</b> 12 INCH/30.48 CM WIDE HANDLE   28MM THICK                      ROUND GRIP   RUBBER HANDLE GRIP   12 STRAND MAIN LINE                      60FT/18.28 M MAIN LINE</p>
SIZE	MASTER CARTON INFO		
128	<p>QUANTITY PER M. CARTON: 1                      M. CARTON WEIGHT (KG): 7,7                      M. CARTON WEIGHT (LBS): 16,94                      M. CARTON SIZE (M): 1,39 X 0,5 X 0,18                      M. CARTON SIZE (INCH): 61,02 X 19,69 X 7,09</p>		



▶ TRANSPARENT WAKEBOARD BAG 142



▶ MAZE WAKEBOARD BINDINGS



▶ WAKE COMBO PRIME RED

**LOGO WAKEBOARD 138 & MAZE BINDINGS PACKAGE**

ITEM NUMBER	EAN CODE	HS CODE	FEATURES
278819059	STAND 8718181018135	95062900	<b>BOARD:</b> TRADITIONAL FOAM CORE   HIGH PRESS FIBERGLASS MOLDED   MOLDED FINS   3-STAGE ROCKER   DOUBLE CONCAVE BOTTOM DESIGN FOR SMOOTH LANDINGS <b>BASE BOARD:</b> EVERYTHING YOU NEED FOR AWESOMESS (FOR A GREAT PRICE)
<b>SIZE</b>		<b>MASTER CARTON INFO</b>	<b>BINDINGS:</b> ADJUSTABLE SHOE SIZES STRETCHY FLEX PANELS TO CONTROL YOUR RIDE SINGLE LACE PERFECT WRAPPED FIT CUSTOM JOBE LACE LOCK TO SECURE YOUR RIDE.
STAND		QUANTITY PER M. CARTON: 1 M. CARTON WEIGHT (KG): 7,7 M. CARTON WEIGHT (LBS): 16,94 M. CARTON SIZE (M): 1,55X0,5X0,18 M. CARTON SIZE (INCH): 61,02X19,69X7,09	<b>HANDLE:</b> 12 INCH/30,48 CM WIDE HANDLE   28MM THICK ROUND GRIP   RUBBER HANDLE GRIP   12 STRAND MAIN LINE 60FT/18,28 M MAIN LINE



▶ TRANSPARENT WAKEBOARD BAG 142



▶ MAZE WAKEBOARD BINDINGS



▶ WAKE COMBO PRIME BLUE

**VANITY WAKEBOARD 131 & MAZE BINDINGS PACKAGE**

ITEM NUMBER	EAN CODE	HS CODE	FEATURES
278819056	STAND 8718181018104	95062900	<b>BOARD:</b> TRADITIONAL FOAM CORE   HIGH PRESS FIBERGLASS MOLDED   CONTINUOUS ROCKER   DEEP GROOVED CHANNELS FOR TRACTION AND CONTROL   MOLDED FINS BASE BOARD: EVERYTHING YOU NEED FOR AWESOMESS (FOR A GREAT PRICE)
<b>SIZE</b>		<b>MASTER CARTON INFO</b>	<b>BINDINGS:</b> ADJUSTABLE SHOE SIZES STRETCHY FLEX PANELS TO CONTROL YOUR RIDE SINGLE LACE PERFECT WRAPPED FIT CUSTOM JOBE LACE LOCK TO SECURE YOUR RIDE.
STAND		QUANTITY PER M. CARTON: 1 M. CARTON WEIGHT (KG): 7,7 M. CARTON WEIGHT (LBS): 16,94 M. CARTON SIZE (M): 1,55X0,5X0,18 M. CARTON SIZE (INCH): 61,02X19,69X7,09	<b>HANDLE:</b> 12 INCH/30.48 CM WIDE HANDLE   28MM THICK ROUND GRIP   RUBBER HANDLE GRIP   12 STRAND MAIN LINE 60FT/18.28 M MAIN LINE



▶ TRANSPARENT WAKEBOARD BAG 142



▶ MAZE WAKEBOARD BINDINGS



▶ WAKE COMBO PRIME BLUE

**VANITY WAKEBOARD 136 & MAZE BINDINGS PACKAGE**

ITEM NUMBER	EAN CODE	HS CODE	FEATURES
278819057	STAND 8718181018111	95062900	<b>BOARD:</b> TRADITIONAL FOAM CORE   HIGH PRESS FIBERGLASS MOLDED   CONTINUOUS ROCKER   DEEP GROOVED CHANNELS FOR TRACTION AND CONTROL   MOLDED FINS BASE BOARD: EVERYTHING YOU NEED FOR AWESOMESS (FOR A GREAT PRICE)
<b>SIZE</b>		<b>MASTER CARTON INFO</b>	<b>BINDINGS:</b> ADJUSTABLE SHOE SIZES STRETCHY FLEX PANELS TO CONTROL YOUR RIDE SINGLE LACE PERFECT WRAPPED FIT CUSTOM JOBE LACE LOCK TO SECURE YOUR RIDE.
STAND		QUANTITY PER M. CARTON: 1 M. CARTON WEIGHT (KG): 7,7 M. CARTON WEIGHT (LBS): 16,94 M. CARTON SIZE (M): 1,55X0,5X0,18 M. CARTON SIZE (INCH): 61,02X19,69X7,09	<b>HANDLE:</b> 12 INCH/30.48 CM WIDE HANDLE   28MM THICK ROUND GRIP   RUBBER HANDLE GRIP   12 STRAND MAIN LINE   60FT/18.28 M MAIN LINE



▶ TRANSPARENT WAKEBOARD BAG 142



▶ MAZE WAKEBOARD BINDINGS



▶ WAKE COMBO PRIME BLUE

**VANITY WAKEBOARD 141 & MAZE BINDINGS PACKAGE**

ITEM NUMBER	EAN CODE	HS CODE	FEATURES
278819058	STAND 8718181018128	95062900	<b>BOARD:</b> TRADITIONAL FOAM CORE   HIGH PRESS FIBERGLASS MOLDED   CONTINUOUS ROCKER   DEEP GROOVED CHANNELS FOR TRACTION AND CONTROL   MOLDED FINS BASE BOARD: EVERYTHING YOU NEED FOR AWESOMESS (FOR A GREAT PRICE)
<b>SIZE</b>		<b>MASTER CARTON INFO</b>	<b>BINDINGS:</b> ADJUSTABLE SHOE SIZES STRETCHY FLEX PANELS TO CONTROL YOUR RIDE SINGLE LACE PERFECT WRAPPED FIT CUSTOM JOBE LACE LOCK TO SECURE YOUR RIDE.
STAND		QUANTITY PER M. CARTON: 1 M. CARTON WEIGHT (KG): 7,7 M. CARTON WEIGHT (LBS): 16,94 M. CARTON SIZE (M): 1,55X0,5X0,18 M. CARTON SIZE (INCH): 61,02X19,69X7,09	<b>HANDLE:</b> 12 INCH/30,48 CM WIDE HANDLE   28MM THICK ROUND GRIP   RUBBER HANDLE GRIP   12 STRAND MAIN LINE 60FT/18,28 M MAIN LINE





▶ TRANSPARENT WAKEBOARD BAG 142



▶ UNIT WAKEBOARD BINDINGS



▶ WAKE COMBO PRIME RED

**LOGO WAKEBOARD 138 & UNIT BINDINGS PACKAGE**

ITEM NUMBER	EAN CODE	HS CODE	FEATURES
278819065	3/6 8718181018326 7/10 8718181018340 10/12 8718181018319	95062900	<b>BOARD:</b> TRADITIONAL FOAM CORE   HIGH PRESS FIBERGLASS MOLDED   MOLDED FINS   3-STAGE ROCKER   DOUBLE CONCAVE BOTTOM DESIGN FOR SMOOTH LANDINGS   BASE BOARD: EVERYTHING YOU NEED FOR AWESOMESS (FOR A GREAT PRICE) <b>BINDINGS:</b> ADJUSTABLE SHOE SIZES STRETCHY FLEX PANELS TO CONTROL YOUR RIDE SINGLE LACE PERFECT WRAPPED FIT CUSTOM JOBE LACE LOCK TO SECURE YOUR RIDE. <b>HANDLE:</b> 12 INCH/30.48 CM WIDE HANDLE   28MM THICK ROUND GRIP   RUBBER HANDLE GRIP   12 STRAND MAIN LINE   60FT/18.28 M MAIN LINE
<b>SIZE</b>		<b>MASTER CARTON INFO</b>	
3/6   7/10   10/12		QUANTITY PER M. CARTON: 1 M. CARTON WEIGHT (KG): 7,7 M. CARTON WEIGHT (LBS): 16,94 M. CARTON SIZE (M): 1,55X0,5X0,38 M. CARTON SIZE (INCH): 61,02X19,69X7,09	



▶ TRANSPARENT WAKEBOARD BAG 142



▶ UNIT WAKEBOARD BINDINGS



▶ WAKE COMBO PRIME BLUE

**VANITY WAKEBOARD 131 & UNIT BINDINGS PACKAGE**

ITEM NUMBER	EAN CODE	HS CODE	FEATURES
278819060	3/6 8718181018159 7/10 8718181018166 10/12 8718181018142	95062900	<b>BOARD:</b> TRADITIONAL FOAM CORE   HIGH PRESS FIBERGLASS MOLDED   CONTINUOUS ROCKER   DEEP GROOVED CHANNELS FOR TRACTION AND CONTROL   MOLDED FINS BASE BOARD: EVERYTHING YOU NEED FOR AWESOMESS (FOR A GREAT PRICE)
<b>SIZE</b>		<b>MASTER CARTON INFO</b>	<b>BINDINGS:</b> ADJUSTABLE SHOE SIZES STRETCHY FLEX PANELS TO CONTROL YOUR RIDE SINGLE LACE PERFECT WRAPPED FIT CUSTOM JOBE LACE LOCK TO SECURE YOUR RIDE.
3/6   7/10   10/12		QUANTITY PER M. CARTON: 1 M. CARTON WEIGHT (KG): 7,7 M. CARTON WEIGHT (LBS): 16,94 M. CARTON SIZE (M): 1,55X0,5X0,18 M. CARTON SIZE (INCH): 61,02X19,69X7,09	<b>HANDLE:</b> 12 INCH/30,48 CM WIDE HANDLE   28MM THICK ROUND GRIP   RUBBER HANDLE GRIP   12 STRAND MAIN LINE   60FT/18,28 M MAIN LINE



▶ TRANSPARENT WAKEBOARD BAG 142



▶ UNIT WAKEBOARD BINDINGS



▶ WAKE COMBO PRIME BLUE

**VANITY WAKEBOARD 136 & UNIT BINDINGS PACKAGE**

ITEM NUMBER	EAN CODE	HS CODE	FEATURES
278819061	3/6 8718181018180 7/10 8718181018197 10/12 8718181018173	95062900	<b>BOARD:</b> TRADITIONAL FOAM CORE   HIGH PRESS FIBERGLASS MOLDED   CONTINUOUS ROCKER   DEEP GROOVED CHANNELS FOR TRACTION AND CONTROL   MOLDED FINS BASE BOARD: EVERYTHING YOU NEED FOR AWESOMESS (FOR A GREAT PRICE)
<b>SIZE</b>		<b>MASTER CARTON INFO</b>	<b>BINDINGS:</b> ADJUSTABLE SHOE SIZES STRETCHY FLEX PANELS TO CONTROL YOUR RIDE SINGLE LACE PERFECT WRAPPED FIT CUSTOM JOBE LACE LOCK TO SECURE YOUR RIDE.
3/6   7/10   10/12		QUANTITY PER M. CARTON: 1 M. CARTON WEIGHT (KG): 7,7 M. CARTON WEIGHT (LBS): 16,94 M. CARTON SIZE (M): 1,55X0,5X0,18 M. CARTON SIZE (INCH): 61,02X19,69X7,09	<b>HANDLE:</b> 12 INCH/30.48 CM WIDE HANDLE   28MM THICK ROUND GRIP   RUBBER HANDLE GRIP   12 STRAND MAIN LINE   60FT/18.28 M MAIN LINE



► TRANSPARENT WAKEBOARD BAG 142



► UNIT WAKEBOARD BINDINGS



► WAKE COMBO PRIME BLUE

**VANITY WAKEBOARD 141 & UNIT BINDINGS PACKAGE**

ITEM NUMBER	EAN CODE	HS CODE	FEATURES
278819062	3/6 8718181018210 7/10 8718181018227 10/12 8718181018203	95062900	<b>BOARD:</b> TRADITIONAL FOAM CORE   HIGH PRESS FIBERGLASS MOLDED   CONTINUOUS ROCKER   DEEP GROOVED CHANNELS FOR TRACTION AND CONTROL   MOLDED FINS BASE BOARD: EVERYTHING YOU NEED FOR AWESOMESS (FOR A GREAT PRICE)
<b>SIZE</b>		<b>MASTER CARTON INFO</b>	<b>BINDINGS:</b> ADJUSTABLE SHOE SIZES STRETCHY FLEX PANELS TO CONTROL YOUR RIDE SINGLE LACE PERFECT WRAPPED FIT CUSTOM JOBE LACE LOCK TO SECURE YOUR RIDE.
3/6   7/10   10/12		QUANTITY PER M. CARTON: 1 M. CARTON WEIGHT (KG): 7,7 M. CARTON WEIGHT (LBS): 16,94 M. CARTON SIZE (M): 1,55X0,5X0,18 M. CARTON SIZE (INCH): 61,02X19,69X7,09	<b>HANDLE:</b> 12 INCH/30.48 CM WIDE HANDLE   28MM THICK ROUND GRIP   RUBBER HANDLE GRIP   12 STRAND MAIN LINE   60FT/18.28 M MAIN LINE



▶ TRANSPARENT WAKEBOARD BAG 142



▶ UNIT WAKEBOARD BINDINGS



▶ WAKE COMBO PRIME RED

**VANITY WAKEBOARD WOMEN 131 & UNIT BINDINGS PACKAGE**

ITEM NUMBER	EAN CODE	HS CODE	FEATURES
278819063	3/6 8718181018258 7/10 8718181018265 10/12 8718181018241	95062900	<b>BOARD:</b> TRADITIONAL FOAM CORE   HIGH PRESS FIBERGLASS MOLDED   CONTINUOUS ROCKER   DEEP GROOVED CHANNELS FOR TRACTION AND CONTROL   MOLDED FINS BASE BOARD: EVERYTHING YOU NEED FOR AWESOMESS (FOR A GREAT PRICE)
<b>SIZE</b>		<b>MASTER CARTON INFO</b>	<b>BINDINGS:</b> ADJUSTABLE SHOE SIZES STRETCHY FLEX PANELS TO CONTROL YOUR RIDE SINGLE LACE PERFECT WRAPPED FIT CUSTOM JOBE LACE LOCK TO SECURE YOUR RIDE.
3/6   7/10   10/12		QUANTITY PER M. CARTON: 1 M. CARTON WEIGHT (KG): 7,7 M. CARTON WEIGHT (LBS): 16,94 M. CARTON SIZE (M): 1,55 X 0,5 X 0,18 M. CARTON SIZE (INCH): 61,02 X 19,69 X 7,09	<b>HANDLE:</b> 12 INCH/30,48 CM WIDE HANDLE   28MM THICK ROUND GRIP   RUBBER HANDLE GRIP   12 STRAND MAIN LINE 60FT/18,28 M MAIN LINE



▶ TRANSPARENT WAKEBOARD BAG 142



▶ UNIT WAKEBOARD BINDINGS



▶ WAKE COMBO PRIME RED

**VANITY WAKEBOARD WOMEN 136 & UNIT BINDINGS PACKAGE**

ITEM NUMBER	EAN CODE	HS CODE	FEATURES
278819064	3/6 8718181018289 7/10 8718181018296 10/12 8718181018272	95062900	<b>BOARD:</b> TRADITIONAL FOAM CORE   HIGH PRESS FIBERGLASS MOLDED   CONTINUOUS ROCKER   DEEP GROOVED CHANNELS FOR TRACTION AND CONTROL   MOLDED FINS BASE BOARD: EVERYTHING YOU NEED FOR AWESOMESS (FOR A GREAT PRICE)
<b>SIZE</b>		<b>MASTER CARTON INFO</b>	<b>BINDINGS:</b> ADJUSTABLE SHOE SIZES STRETCHY FLEX PANELS TO CONTROL YOUR RIDE SINGLE LACE PERFECT WRAPPED FIT CUSTOM JOBE LACE LOCK TO SECURE YOUR RIDE.
3/6   7/10   10/12		QUANTITY PER M. CARTON: 1 M. CARTON WEIGHT (KG): 7,7 M. CARTON WEIGHT (LBS): 16,94 M. CARTON SIZE (M): 1,55 X 0,5 X 0,18 M. CARTON SIZE (INCH): 61,02 X 19,69 X 7,09	<b>HANDLE:</b> 12 INCH/30.48 CM WIDE HANDLE   28MM THICK ROUND GRIP   RUBBER HANDLE GRIP   12 STRAND MAIN LINE   60FT/18.28 M MAIN LINE



► TRANSPARENT WAKEBOARD BAG 142



► HOST WAKEBOARD BINDINGS PINK



► WAKE COMBO PRIME RED

**VANITY WAKEBOARD WMN 131 & HOST BINDINGS PINK PACKAGE**

ITEM NUMBER	EAN CODE	HS CODE	FEATURES
278819066	3/6 8718181018357 7/10 8718181018364	95062900	<p><b>BOARD:</b> TRADITIONAL FOAM CORE   HIGH PRESS FIBERGLASS MOLDED   CONTINUOUS ROCKER   DEEP GROOVED CHANNELS FOR TRACTION AND CONTROL   MOLDED FINN   BASE BOARD: EVERYTHING YOU NEED FOR AWESOMESS (FOR A GREAT PRICE)</p> <p><b>BINDINGS:</b> ADJUSTABLE SHOE SIZES COMFORTABLE ERGONOMIC FOOT BED SOFT HEEL PADS FOR PROPER FOOT PLACEMENT SOFT AND COMFORTABLE FOAM INNER LINER USER FRIENDLY VELCRO STRAPS FOR A FAST ENTRY</p> <p><b>HANDLE:</b> 12 INCH/30.48 CM WIDE HANDLE   28MM THICK ROUND GRIP   RUBBER HANDLE GRIP   12 STRAND MAIN LINE 60FT/18.28 M MAIN LINE</p>
SIZE	3/6   7/10	MASTER CARTON INFO	
		<p>QUANTITY PER M. CARTON: 1</p> <p>M. CARTON WEIGHT (KG): 7,7</p> <p>M. CARTON WEIGHT (LBS): 16,94</p> <p>M. CARTON SIZE (M): 1,55X0,5X0,18</p> <p>M. CARTON SIZE (INCH): 61,02X19,69X7,09</p>	



▶ TRANSPARENT WAKEBOARD BAG 142



▶ HOST WAKEBOARD BINDINGS PINK



▶ WAKE COMBO PRIME RED

**VANITY WAKEBOARD WMN 136 & HOST BINDINGS PINK PACKAGE**

ITEM NUMBER	EAN CODE	HS CODE	FEATURES
278819067	3/6 8718181018371 7/10 8718181018388	95062900	<b>BOARD:</b> TRADITIONAL FOAM CORE   HIGH PRESS FIBERGLASS MOLDED   CONTINUOUS ROCKER   DEEP GROOVED CHANNELS FOR TRACTION AND CONTROL   MOLDED FINN   BASE BOARD: EVERYTHING YOU NEED FOR AWESOMESS (FOR A GREAT PRICE) <b>BINDINGS:</b> ADJUSTABLE SHOE SIZES COMFORTABLE ERGONOMIC FOOT BED SOFT HEEL PADS FOR PROPER FOOT PLACEMENT SOFT AND COMFORTABLE FOAM INNER LINER USER FRIENDLY VELCRO STRAPS FOR A FAST ENTRY <b>HANDLE:</b> 12 INCH/30.48 CM WIDE HANDLE   28MM THICK ROUND GRIP   RUBBER HANDLE GRIP   12 STRAND MAIN LINE   60FT/18.28 M MAIN LINE
SIZE	MASTER CARTON INFO		
3/6   7/10	QUANTITY PER M. CARTON:	1	
	M. CARTON WEIGHT (KG):	7,7	
	M. CARTON WEIGHT (LBS):	16,94	
	M. CARTON SIZE (M):	1,55X0,5X0,18	
	M. CARTON SIZE (INCH):	61,02X19,69X7,09	





# NITRO BINDING TECHNOLOGY



CUSTOM LACE LOCK FOR A SECURED FIT

LACE POCKETS

STRETCH FLEX PANELS TO CONTROL YOUR RIDE

COMFORTABLE ERGONOMIC FOOTBED FOR GREAT SUPPORT

NEW TOE CAP DESIGN

IMPROVED HEEL RESPONSE

NEW STIFF AND DURABLE BASEPLATE DESIGN



► MAZE WAKEBOARD BINDINGS

**LOGO WAKEBOARD 138 & MAZE BINDINGS SET**

ITEM NUMBER	EAN CODE	HS CODE	FEATURES
278819054	STAND 8718181018043	95062900	<p><b>BOARD</b>                      TRADITIONAL FOAM CORE                      HIGH PRESS FIBERGLASS MOLDED                      MOLDED FINS   3-STAGE ROCKER                      DOUBLE CONCAVE BOTTOM DESIGN FOR SMOOTH LANDINGS                      BASE BOARD: EVERYTHING YOU NEED FOR AWESOMESS (FOR A GREAT PRICE)</p> <p><b>BINDINGS</b>                      ADJUSTABLE SHOE SIZES                      STRETCHY FLEX PANELS TO CONTROL YOUR RIDE                      SINGLE LACE PERFECT WRAPPED FIT                      CUSTOM JOBE LACE LOCK TO SECURE YOUR RIDE.</p>
<b>SIZE</b>	<b>CARTON INFO BOARD</b>	<b>CARTON INFO BINDING</b>	
STAND	QUANTITY PER M. CARTON: 1 M. CARTON WEIGHT (KG): 1 M. CARTON WEIGHT (LBS): 14,3 M. CARTON SIZE (M): 1,5 X 0,51 X 0,1 M. CARTON SIZE (INCH): 59,05 X 20,08 X 3,94	QUANTITY PER M. CARTON: 1 M. CARTON WEIGHT (KG): 1,7 M. CARTON WEIGHT (LBS): 3,74 M. CARTON SIZE (M): 0,30 X 0,15 X 0,12 M. CARTON SIZE (INCH): 11,81 X 5,90 X 4,72	



► MAZE WAKEBOARD BINDINGS

**VANITY WAKEBOARD 131 & MAZE BINDINGS SET**

ITEM NUMBER	EAN CODE	HS CODE	FEATURES
278819051	STAND 8718181018005	95062900	<p><b>BOARD</b>                      TRADITIONAL FOAM CORE                      HIGH PRESS FIBERGLASS MOLDED   CONTINUOUS ROCKER                      DEEP GROOVED CHANNELS FOR TRACTION AND CONTROL                      MOLDED FINS                      BASE BOARD: EVERYTHING YOU NEED FOR AWESOMESS (FOR A GREAT PRICE)</p> <p><b>BINDINGS</b>                      ADJUSTABLE SHOE SIZES                      STRETCHY FLEX PANELS TO CONTROL YOUR RIDE                      SINGLE LACE PERFECT WRAPPED FIT                      CUSTOM JOBE LACE LOCK TO SECURE YOUR RIDE.</p>
<b>SIZE</b>	<b>CARTON INFO BOARD</b>	<b>CARTON INFO BINDING</b>	
STAND	QUANTITY PER M. CARTON: 1 M. CARTON WEIGHT (KG): 1 M. CARTON WEIGHT (LBS): 14,3 M. CARTON SIZE (M): 1,5 X 0,51 X 0,1 M. CARTON SIZE (INCH): 59,05 X 20,08 X 3,94	QUANTITY PER M. CARTON: 1 M. CARTON WEIGHT (KG): 1,7 M. CARTON WEIGHT (LBS): 3,74 M. CARTON SIZE (M): 0,30 X 0,15 X 0,12 M. CARTON SIZE (INCH): 11,81 X 5,90 X 4,72	



► MAZE WAKEBOARD BINDINGS

**VANITY WAKEBOARD 136 & MAZE BINDINGS SET**

ITEM NUMBER	EAN CODE	HS CODE	FEATURES
278819052	STAND 8718181018029	95062900	<b>BOARD</b> TRADITIONAL FOAM CORE HIGH PRESS FIBERGLASS MOLDED CONTINUOUS ROCKER DEEP GROOVED CHANNELS FOR TRACTION AND CONTROL MOLDED FINS BASE BOARD: EVERYTHING YOU NEED TO BE AWESOME
<b>SIZE</b>	<b>CARTON INFO BOARD</b>	<b>CARTON INFO BINDING</b>	<b>BINDINGS</b>
STAND	QUANTITY PER M. CARTON: 1 M. CARTON WEIGHT (KG): 1 M. CARTON WEIGHT (LBS): 14,3 M. CARTON SIZE (M): 1,5 X 0,51 X 0,1 M. CARTON SIZE (INCH): 59,05 X 20,08 X 3,94	QUANTITY PER M. CARTON: 1 M. CARTON WEIGHT (KG): 1,7 M. CARTON WEIGHT (LBS): 3,74 M. CARTON SIZE (M): 0,30 X 0,15 X 0,12 M. CARTON SIZE (INCH): 11,81 X 5,90 X 4,72	ADJUSTABLE SHOE SIZES STRETCHY FLEX PANELS TO CONTROL YOUR RIDE SINGLE LACE PERFECT WRAPPED FIT CUSTOM JOBE LACE LOCK TO SECURE YOUR RIDE.



► MAZE WAKEBOARD BINDINGS

**VANITY WAKEBOARD 141 & MAZE BINDINGS SET**

ITEM NUMBER	EAN CODE	HS CODE	FEATURES
278819053	STAND 8718181018036	95062900	<p><b>BOARD</b></p> <p>TRADITIONAL FOAM CORE                      HIGH PRESS FIBERGLASS MOLDED   CONTINUOUS ROCKER                      DEEP GROOVED CHANNELS FOR TRACTION AND CONTROL                      MOLDED FINs                      BASE BOARD: EVERYTHING YOU NEED FOR AWESOMESS (FOR A GREAT PRICE)</p> <p><b>BINDINGS</b></p> <p>ADJUSTABLE SHOE SIZES                      STRETCHY FLEX PANELS TO CONTROL YOUR RIDE                      SINGLE LACE PERFECT WRAPPED FIT                      CUSTOM JOBE LACE LOCK TO SECURE YOUR RIDE.</p>
<b>SIZE</b>	<b>CARTON INFO BOARD</b>	<b>CARTON INFO BINDING</b>	
STAND	<p>QUANTITY PER M. CARTON: 1</p> <p>M. CARTON WEIGHT (KG): 1</p> <p>M. CARTON WEIGHT (LBS): 14,3</p> <p>M. CARTON SIZE (M): 1,5 X 0,51 X 0,1</p> <p>M. CARTON SIZE (INCH): 59,05 X 20,08 X 3,94</p>	<p>QUANTITY PER M. CARTON: 1</p> <p>M. CARTON WEIGHT (KG): 1,7</p> <p>M. CARTON WEIGHT (LBS): 3,74</p> <p>M. CARTON SIZE (M): 0,30 X 0,15 X 0,12</p> <p>M. CARTON SIZE (INCH): 11,81 X 5,90 X 4,72</p>	



► UNIT WAKEBOARD BINDINGS

**LOGO WAKEBOARD 138 & UNIT BINDINGS SET**

ITEM NUMBER	EAN CODE	HS CODE	FEATURES
278819055	3/6 8718181018067 7/10 8718181018081 10/12 8718181018050	95062900	<b>BOARD</b> TRADITIONAL FOAM CORE HIGH PRESS FIBERGLASS MOLDED MOLDED FINS   3-STAGE ROCKER DOUBLE CONCAVE BOTTOM DESIGN FOR SMOOTH LANDINGS BASE BOARD: EVERYTHING YOU NEED FOR AWESOMESS (FOR A GREAT PRICE)
<b>SIZE</b>			<b>BINDINGS</b> ADJUSTABLE SHOE SIZES STRETCHY FLEX PANELS TO CONTROL YOUR RIDE SINGLE LACE PERFECT WRAPPED FIT CUSTOM JOBE LACE LOCK TO SECURE YOUR RIDE.
3/6   7/10   10/12	<b>CARTON INFO BOARD</b> QUANTITY PER M. CARTON: 1 M. CARTON WEIGHT (KG): 1 M. CARTON WEIGHT (LBS): 14,3 M. CARTON SIZE (M): 1,5 X 0,51 X 0,1 M. CARTON SIZE (INCH): 59,05 X 20,08 X 3,94	<b>CARTON INFO BINDING</b> QUANTITY PER M. CARTON: 1 M. CARTON WEIGHT (KG): 2,34 M. CARTON WEIGHT (LBS): 5,15 M. CARTON SIZE (M): 0,38 X 0,34 X 0,19 M. CARTON SIZE (INCH): 14,96 X 13,39 X 7,48	



► UNIT WAKEBOARD BINDINGS

**VANITY WAKEBOARD 131 & UNIT BINDINGS SET**

ITEM NUMBER	EAN CODE	HS CODE	FEATURES
278819046	3/6 8718181017879 7/10 8718181017886 10/12 8718181017862	95062900	<b>BOARD</b> TRADITIONAL FOAM CORE HIGH PRESS FIBERGLASS MOLDED   CONTINUOUS ROCKER DEEP GROOVED CHANNELS FOR TRACTION AND CONTROL MOLDED FINIS BASE BOARD: EVERYTHING YOU NEED FOR AWESOMESS (FOR A GREAT PRICE)
<b>SIZE</b>	<b>CARTON INFO BOARD</b>	<b>CARTON INFO BINDING</b>	<b>BINDINGS</b>
3/6   7/10   10/12	QUANTITY PER M. CARTON: 1 M. CARTON WEIGHT (KG): 1 M. CARTON WEIGHT (LBS): 14,3 M. CARTON SIZE (M): 1,5 X 0,51 X 0,1 M. CARTON SIZE (INCH): 59,05 X 20,08 X 3,94	QUANTITY PER M. CARTON: 1 M. CARTON WEIGHT (KG): 2,34 M. CARTON WEIGHT (LBS): 5,15 M. CARTON SIZE (M): 0,38 X 0,34 X 0,19 M. CARTON SIZE (INCH): 14,96 X 13,39 X 7,48	ADJUSTABLE SHOE SIZES STRETCHY FLEX PANELS TO CONTROL YOUR RIDE SINGLE LACE PERFECT WRAPPED FIT CUSTOM JOBE LACE LOCK TO SECURE YOUR RIDE.





► UNIT WAKEBOARD BINDINGS

**VANITY WAKEBOARD 136 & UNIT BINDINGS SET**

ITEM NUMBER	EAN CODE	HS CODE	FEATURES
278819047	3/6 8718181017909 7/10 8718181017916 10/12 8718181017893	95062900	<p><b>BOARD</b>                      TRADITIONAL FOAM CORE   HIGH PRESS FIBERGLASS MOLDED CONTINUOUS ROCKER                      DEEP GROOVED CHANNELS FOR TRACTION AND CONTROL                      MOLDED FINs                      BASE BOARD: EVERYTHING YOU NEED FOR AWESOMESS (FOR A GREAT PRICE)</p> <p><b>BINDINGS</b>                      ADJUSTABLE SHOE SIZES                      STRETCHY FLEX PANELS TO CONTROL YOUR RIDE                      SINGLE LACE PERFECT WRAPPED FIT                      CUSTOM JOBE LACE LOCK TO SECURE YOUR RIDE.</p>
<b>SIZE</b>	<b>CARTON INFO BOARD</b>	<b>CARTON INFO BINDING</b>	
3/6   7/10   10/12	QUANTITY PER M. CARTON: 1 M. CARTON WEIGHT (KG): 1 M. CARTON WEIGHT (LBS): 14,3 M. CARTON SIZE (M): 1,5 X 0,51 X 0,1 M. CARTON SIZE (INCH): 59,05 X 20,08 X 3,94	QUANTITY PER M. CARTON: 1 M. CARTON WEIGHT (KG): 2,34 M. CARTON WEIGHT (LBS): 5,15 M. CARTON SIZE (M): 0,38 X 0,34 X 0,19 M. CARTON SIZE (INCH): 14,96 X 13,39 X 7,48	



► UNIT WAKEBOARD BINDINGS

**VANITY WAKEBOARD 141 & UNIT BINDINGS SET**

ITEM NUMBER	EAN CODE	HS CODE	FEATURES
278819048	3/6 8718181017930 7/10 8718181017947 10/12 8718181017923	95062900	<p><b>BOARD</b>                      TRADITIONAL FOAM CORE                      HIGH PRESS FIBERGLASS MOLDED   CONTINUOUS ROCKER                      DEEP GROOVED CHANNELS FOR TRACTION AND CONTROL                      MOLDED FINs                      BASE BOARD: EVERYTHING YOU NEED FOR AWESOMESS (FOR A GREAT PRICE)</p> <p><b>BINDINGS</b>                      ADJUSTABLE SHOE SIZES                      STRETCHY FLEX PANELS TO CONTROL YOUR RIDE                      SINGLE LACE PERFECT WRAPPED FIT                      CUSTOM JOBE LACE LOCK TO SECURE YOUR RIDE.</p>
<b>SIZE</b>	<b>CARTON INFO BOARD</b>	<b>CARTON INFO BINDING</b>	
3/6   7/10   10/12	QUANTITY PER M. CARTON: 1 M. CARTON WEIGHT (KG): 1 M. CARTON WEIGHT (LBS): 14,3 M. CARTON SIZE (M): 1,5 X 0,51 X 0,1 M. CARTON SIZE (INCH): 59,05 X 20,08 X 3,94	QUANTITY PER M. CARTON: 1 M. CARTON WEIGHT (KG): 2,34 M. CARTON WEIGHT (LBS): 5,15 M. CARTON SIZE (M): 0,38 X 0,34 X 0,19 M. CARTON SIZE (INCH): 14,96 X 13,39 X 7,48	



► UNIT WAKEBOARD BINDINGS

**VANITY WAKEBOARD WOMEN 131 & UNIT BINDINGS SET**

ITEM NUMBER	EAN CODE	HS CODE	FEATURES
278819068	3/6 8718181018395 7/10 8718181018401	95062900	<p><b>BOARD</b></p> <p>TRADITIONAL FOAM CORE HIGH PRESS FIBERGLASS MOLDED   CONTINUOUS ROCKER DEEP GROOVED CHANNELS FOR TRACTION AND CONTROL MOLDED FINIS BASE BOARD: EVERYTHING YOU NEED FOR AWESOMESS (FOR A GREAT PRICE)</p> <p><b>BINDINGS</b></p> <p>ADJUSTABLE SHOE SIZES STRETCHY FLEX PANELS TO CONTROL YOUR RIDE SINGLE LACE PERFECT WRAPPED FIT CUSTOM JOBE LACE LOCK TO SECURE YOUR RIDE.</p>
<b>SIZE</b>	<b>CARTON INFO BOARD</b>	<b>CARTON INFO BINDING</b>	
3/6   7/10	<p>QUANTITY PER M. CARTON: 1</p> <p>M. CARTON WEIGHT (KG): 1</p> <p>M. CARTON WEIGHT (LBS): 14,3</p> <p>M. CARTON SIZE (M): 1,5 X 0,51 X 0,1</p> <p>M. CARTON SIZE (INCH): 59,05 X 20,08 X 3,94</p>	<p>QUANTITY PER M. CARTON: 1</p> <p>M. CARTON WEIGHT (KG): 2,34</p> <p>M. CARTON WEIGHT (LBS): 5,15</p> <p>M. CARTON SIZE (M): 0,38 X 0,34 X 0,19</p> <p>M. CARTON SIZE (INCH): 14,96 X 13,39 X 7,48</p>	



► UNIT WAKEBOARD BINDINGS

**VANITY WAKEBOARD WOMEN 136 & UNIT BINDINGS SET**

ITEM NUMBER	EAN CODE	HS CODE	FEATURES
278819069	3/6 8718181018418 7/10 8718181018425	95062900	<p><b>BOARD</b>                      TRADITIONAL FOAM CORE                      HIGH PRESS FIBERGLASS MOLDED   CONTINUOUS ROCKER                      DEEP GROOVED CHANNELS FOR TRACTION AND CONTROL                      MOLDED FINIS                      BASE BOARD: EVERYTHING YOU NEED FOR AWESOMESS (FOR A GREAT PRICE)</p>
<b>SIZE</b>			
3/6   7/10	<p><b>CARTON INFO BOARD</b></p> <p>QUANTITY PER M. CARTON: 1                      M. CARTON WEIGHT (KG): 1                      M. CARTON WEIGHT (LBS): 14,3                      M. CARTON SIZE (M): 1,5 X 0,51 X 0,1                      M. CARTON SIZE (INCH): 59,05 X 20,08 X 3,94</p>	<p><b>CARTON INFO BINDING</b></p> <p>QUANTITY PER M. CARTON: 1                      M. CARTON WEIGHT (KG): 2,34                      M. CARTON WEIGHT (LBS): 5,15                      M. CARTON SIZE (M): 0,38 X 0,34 X 0,19                      M. CARTON SIZE (INCH): 14,96 X 13,39 X 7,48</p>	<p><b>BINDINGS</b>                      ADJUSTABLE SHOE SIZES                      STRETCHY FLEX PANELS TO CONTROL YOUR RIDE                      SINGLE LACE PERFECT WRAPPED FIT                      CUSTOM JOBE LACE LOCK TO SECURE YOUR RIDE.</p>



► HOST WAKEBOARD BINDINGS BLUE

**VANITY WAKEBOARD 131 & HOST BINDINGS BLUE SET**

ITEM NUMBER	EAN CODE	HS CODE	FEATURES
278819043	3/6 8718181017756 7/10 8718181017763 10/12 8718181017749	95062900	<p><b>BOARD</b>                      TRADITIONAL FOAM CORE   HIGH PRESS FIBERGLASS MOLDED CONTINUOUS ROCKER   DEEP GROOVED CHANNELS FOR TRACTION AND CONTROL   MOLDED FINS                      BASE BOARD: EVERYTHING YOU NEED FOR AWESOMESS (FOR A GREAT PRICE)</p> <p><b>BINDINGS</b>                      ADJUSTABLE SHOE SIZES                      COMFORTABLE ERGONOMIC FOOT BED                      SOFT HEEL PADS FOR PROPER FOOT PLACEMENT                      SOFT AND COMFORTABLE FOAM INNER LINER                      USER FRIENDLY VELCRO STRAPS FOR A FAST ENTRY</p>
<b>SIZE</b>	<b>CARTON INFO BOARD</b>	<b>CARTON INFO BINDING</b>	
3/6   7/10   10/12	QUANTITY PER M. CARTON: 1 M. CARTON WEIGHT (KG): 1 M. CARTON WEIGHT (LBS): 14,3 M. CARTON SIZE (M): 1,5 X 0,51 X 0,1 M. CARTON SIZE (INCH): 59,05 X 20,08 X 3,94	QUANTITY PER M. CARTON: 1 M. CARTON WEIGHT (KG): 2,76 M. CARTON WEIGHT (LBS): 6,07 M. CARTON SIZE (M): 0,37 X 0,33 X 0,18 M. CARTON SIZE (INCH): 14,57 X 12,99 X 7,09	



► HOST WAKEBOARD BINDINGS BLUE

**VANITY WAKEBOARD 136 & HOST BINDINGS BLUE SET**

ITEM NUMBER	EAN CODE	HS CODE	FEATURES
278819044	3/6 8718181017787 7/10 8718181017794 10/12 8718181017770	95062900	<b>BOARD</b> TRADITIONAL FOAM CORE   HIGH PRESS FIBERGLASS MOLDED CONTINUOUS ROCKER   DEEP GROOVED CHANNELS FOR TRACTION AND CONTROL   MOLDED FINS BASE BOARD: EVERYTHING YOU NEED FOR AWESOMESS (FOR A GREAT PRICE)
<b>SIZE</b>	<b>CARTON INFO BOARD</b>	<b>CARTON INFO BINDING</b>	<b>BINDINGS</b>
3/6   7/10   10/12	QUANTITY PER M. CARTON: 1 M. CARTON WEIGHT (KG): 1 M. CARTON WEIGHT (LBS): 14,3 M. CARTON SIZE (M): 1,5 X 0,51 X 0,1 M. CARTON SIZE (INCH): 59,05 X 20,08 X 3,94	QUANTITY PER M. CARTON: 1 M. CARTON WEIGHT (KG): 2,76 M. CARTON WEIGHT (LBS): 6,07 M. CARTON SIZE (M): 0,37 X 0,33 X 0,18 M. CARTON SIZE (INCH): 14,57 X 12,99 X 7,09	ADJUSTABLE SHOE SIZES COMFORTABLE ERGONOMIC FOOT BED SOFT HEEL PADS FOR PROPER FOOT PLACEMENT SOFT AND COMFORTABLE FOAM INNER LINER USER FRIENDLY VELCRO STRAPS FOR A FAST ENTRY



► HOST WAKEBOARD BINDINGS BLUE

### VANITY WAKEBOARD 141 & HOST BINDINGS BLUE SET

ITEM NUMBER	EAN CODE	HS CODE	FEATURES
278819045	3/6 8718181017824 7/10 8718181017855 10/12 8718181017800	95062900	<b>BOARD</b> TRADITIONAL FOAM CORE   HIGH PRESS FIBERGLASS MOLDED CONTINUOUS ROCKER   DEEP GROOVED CHANNELS FOR TRACTION AND CONTROL   MOLDED FINS BASE BOARD: EVERYTHING YOU NEED FOR AWESOMESS (FOR A GREAT PRICE)
<b>SIZE</b>			<b>BINDINGS</b> ADJUSTABLE SHOE SIZES COMFORTABLE ERGONOMIC FOOT BED SOFT HEEL PADS FOR PROPER FOOT PLACEMENT SOFT AND COMFORTABLE FOAM INNER LINER USER FRIENDLY VELCRO STRAPS FOR A FAST ENTRY
3/6   7/10   10/12	<b>CARTON INFO BOARD</b> QUANTITY PER M. CARTON: 1 M. CARTON WEIGHT (KG): 1 M. CARTON WEIGHT (LBS): 14,3 M. CARTON SIZE (M): 1,5 X 0,51 X 0,1 M. CARTON SIZE (INCH): 59,05 X 20,08 X 3,94	<b>CARTON INFO BINDING</b> QUANTITY PER M. CARTON: 1 M. CARTON WEIGHT (KG): 2,76 M. CARTON WEIGHT (LBS): 6,07 M. CARTON SIZE (M): 0,37 X 0,33 X 0,18 M. CARTON SIZE (INCH): 14,57 X 12,99 X 7,09	



► HOST WAKEBOARD BINDINGS PINK

**VANITY WAKEBOARD WOMEN 131 & HOST BINDINGS PINK SET**

ITEM NUMBER	EAN CODE	HS CODE	FEATURES
278819049	3/6 8718181017954 7/10 8718181017961	95062900	<p><b>BOARD</b>                      TRADITIONAL FOAM CORE   HIGH PRESS FIBERGLASS MOLDED   CONTINUOUS ROCKER   DEEP GROOVED CHANNELS FOR TRACTION AND CONTROL   MOLDED FINS                      BASE BOARD: EVERYTHING YOU NEED FOR AWESOMESS (FOR A GREAT PRICE)</p> <p><b>BINDINGS</b>                      ADJUSTABLE SHOE SIZES                      COMFORTABLE ERGONOMIC FOOT BED                      SOFT HEEL PADS FOR PROPER FOOT PLACEMENT                      SOFT AND COMFORTABLE FOAM INNER LINER                      USER FRIENDLY VELCRO STRAPS FOR A FAST ENTRY</p>
<b>SIZE</b>	<b>CARTON INFO BOARD</b>	<b>CARTON INFO BINDING</b>	
3/6   7/10	QUANTITY PER M. CARTON: 1 M. CARTON WEIGHT (KG): 1 M. CARTON WEIGHT (LBS): 14,3 M. CARTON SIZE (M): 1,5 X 0,51 X 0,1 M. CARTON SIZE (INCH): 59,05 X 20,08 X 3,94	QUANTITY PER M. CARTON: 1 M. CARTON WEIGHT (KG): 2,76 M. CARTON WEIGHT (LBS): 6,07 M. CARTON SIZE (M): 0,37 X 0,33 X 0,18 M. CARTON SIZE (INCH): 14,57 X 12,99 X 7,09	





► HOST WAKEBOARD BINDINGS PINK

### VANITY WAKEBOARD WOMEN 136 & HOST BINDINGS PINK SET

ITEM NUMBER	EAN CODE	HS CODE	FEATURES
278819050	3/6 8718181017978 7/10 8718181017985	95062900	<p><b>BOARD</b></p> <p>TRADITIONAL FOAM CORE   HIGH PRESS FIBERGLASS MOLDED CONTINUOUS ROCKER   DEEP GROOVED CHANNELS FOR TRACTION AND CONTROL   MOLDED FINS</p> <p>BASE BOARD: EVERYTHING YOU NEED FOR AWESOMESS (FOR A GREAT PRICE)</p> <p><b>BINDINGS</b></p> <p>ADJUSTABLE SHOE SIZES COMFORTABLE ERGONOMIC FOOT BED SOFT HEEL PADS FOR PROPER FOOT PLACEMENT SOFT AND COMFORTABLE FOAM INNER LINER USER FRIENDLY VELCRO STRAPS FOR A FAST ENTRY</p>
<b>SIZE</b>	<b>CARTON INFO BOARD</b>	<b>CARTON INFO BINDING</b>	
3/6   7/10	<p>QUANTITY PER M. CARTON: 1</p> <p>M. CARTON WEIGHT (KG): 1</p> <p>M. CARTON WEIGHT (LBS): 14,3</p> <p>M. CARTON SIZE (M): 1,5 X 0,51 X 0,1</p> <p>M. CARTON SIZE (INCH): 59,05 X 20,08 X 3,94</p>	<p>QUANTITY PER M. CARTON: 1</p> <p>M. CARTON WEIGHT (KG): 2,76</p> <p>M. CARTON WEIGHT (LBS): 6,07</p> <p>M. CARTON SIZE (M): 0,37 X 0,33 X 0,18</p> <p>M. CARTON SIZE (INCH): 14,57 X 12,99 X 7,09</p>	



► UNIT WAKEBOARD BINDINGS

**PROLIX WAKEBOARD 134 & UNIT BINDINGS SET**

ITEM NUMBER	EAN CODE	HS CODE	FEATURES
278819040	3/6 8718181017633 7/10 8718181017657 10/12 8718181017626	95062900	<p><b>BOARD</b>                      TRADITIONAL FOAM CORE                      HIGH PRESS FIBERGLASS MOLDED                      HYBRID ROCKER   HIGH IMPACT BASE MATERIAL                      SMOOTH GROOVED CHANNELS FOR TRACTION AND CONTROL                      BASE BOARD: EVERYTHING YOU NEED FOR AWESOMESS (FOR A GREAT PRICE)</p> <p><b>BINDINGS</b>                      ADJUSTABLE SHOE SIZES                      STRETCHY FLEX PANELS TO CONTROL YOUR RIDE                      SINGLE LACE PERFECT WRAPPED FIT                      CUSTOM JOBE LACE LOCK TO SECURE YOUR RIDE.</p>
<b>SIZE</b>			
3/6   7/10   10/12	<p><b>CARTON INFO BOARD</b></p> <p>QUANTITY PER M. CARTON: 1                      M. CARTON WEIGHT (KG): 1                      M. CARTON WEIGHT (LBS): 14,3                      M. CARTON SIZE (M): 1,5 X 0,51 X 0,1                      M. CARTON SIZE (INCH): 59,05 X 20,08 X 3,94</p>	<p><b>CARTON INFO BINDING</b></p> <p>QUANTITY PER M. CARTON: 1                      M. CARTON WEIGHT (KG): 2,34                      M. CARTON WEIGHT (LBS): 5,15                      M. CARTON SIZE (M): 0,38 X 0,34 X 0,19                      M. CARTON SIZE (INCH): 14,96 X 13,39 X 7,48</p>	



► UNIT WAKEBOARD BINDINGS

**PROLIX WAKEBOARD 138 & UNIT BINDINGS SET**

ITEM NUMBER	EAN CODE	HS CODE	FEATURES
278819041	3/6 8718181017695 7/10 8718181017701 10/12 8718181017671	95062900	<p><b>BOARD</b>                      TRADITIONAL FOAM CORE                      HIGH PRESS FIBERGLASS MOLDED                      HYBRID ROCKER   HIGH IMPACT BASE MATERIAL                      SMOOTH GROOVED CHANNELS FOR TRACTION AND CONTROL                      BASE BOARD: EVERYTHING YOU NEED FOR AWESOMESS (FOR A GREAT PRICE)</p> <p><b>BINDINGS</b>                      ADJUSTABLE SHOE SIZES                      STRETCHY FLEX PANELS TO CONTROL YOUR RIDE                      SINGLE LACE PERFECT WRAPPED FIT                      CUSTOM JOBE LACE LOCK TO SECURE YOUR RIDE.</p>
<b>SIZE</b>	<b>CARTON INFO BOARD</b>	<b>CARTON INFO BINDING</b>	
3/6   7/10   10/12	QUANTITY PER M. CARTON: 1 M. CARTON WEIGHT (KG): 1 M. CARTON WEIGHT (LBS): 14,3 M. CARTON SIZE (M): 1,5 X 0,51 X 0,1 M. CARTON SIZE (INCH): 59,05 X 20,08 X 3,94	QUANTITY PER M. CARTON: 1 M. CARTON WEIGHT (KG): 2,34 M. CARTON WEIGHT (LBS): 5,15 M. CARTON SIZE (M): 0,38 X 0,34 X 0,19 M. CARTON SIZE (INCH): 14,96 X 13,39 X 7,48	



► UNIT WAKEBOARD BINDINGS

**PROLIX WAKEBOARD 143 & UNIT BINDINGS SET**

ITEM NUMBER	EAN CODE	HS CODE	FEATURES
278819042	3/6 8718181017725 7/10 8718181017732 10/12 8718181017718	95062900	<p><b>BOARD</b>                      TRADITIONAL FOAM CORE                      HIGH PRESS FIBERGLASS MOLDED                      HYBRID ROCKER   HIGH IMPACT BASE MATERIAL                      SMOOTH GROOVED CHANNELS FOR TRACTION AND CONTROL                      BASE BOARD: EVERYTHING YOU NEED FOR AWESOMESS (FOR A GREAT PRICE)</p> <p><b>BINDINGS</b>                      ADJUSTABLE SHOE SIZES                      STRETCHY FLEX PANELS TO CONTROL YOUR RIDE                      SINGLE LACE PERFECT WRAPPED FIT                      CUSTOM JOBE LACE LOCK TO SECURE YOUR RIDE.</p>
<b>SIZE</b>	<b>CARTON INFO BOARD</b>	<b>CARTON INFO BINDING</b>	
3/6   7/10   10/12	QUANTITY PER M. CARTON: 1 M. CARTON WEIGHT (KG): 1 M. CARTON WEIGHT (LBS): 14,3 M. CARTON SIZE (M): 1,5 X 0,51 X 0,1 M. CARTON SIZE (INCH): 59,05 X 20,08 X 3,94	QUANTITY PER M. CARTON: 1 M. CARTON WEIGHT (KG): 2,34 M. CARTON WEIGHT (LBS): 5,15 M. CARTON SIZE (M): 0,38 X 0,34 X 0,19 M. CARTON SIZE (INCH): 14,96 X 13,39 X 7,48	



► UNIT WAKEBOARD BINDINGS

**MADDOX WAKEBOARD 138 & UNIT BINDINGS SET**

ITEM NUMBER	EAN CODE	HS CODE	FEATURES
278819035	3/6 8718181017473 7/10 8718181017480 10/12 8718181017466	95062900	<p><b>BOARD</b></p> <p>TRADITIONAL FOAM CORE HIGH PRESS FIBERGLASS MOLDED 3-STAGE ROCKER DEEP GROOVED CHANNELS FOR TRACTION AND CONTROL BASE BOARD: EVERYTHING YOU NEED FOR AWESOMESS (FOR A GREAT PRICE)</p> <p><b>BINDINGS</b></p> <p>ADJUSTABLE SHOE SIZES STRETCHY FLEX PANELS TO CONTROL YOUR RIDE SINGLE LACE PERFECT WRAPPED FIT CUSTOM JOBE LACE LOCK TO SECURE YOUR RIDE.</p>
<b>SIZE</b>	<b>CARTON INFO BOARD</b>	<b>CARTON INFO BINDING</b>	
3/6   7/10   10/12	<p>QUANTITY PER M. CARTON: 1</p> <p>M. CARTON WEIGHT (KG): 1</p> <p>M. CARTON WEIGHT (LBS): 14,3</p> <p>M. CARTON SIZE (M): 1,5 X 0,51 X 0,1</p> <p>M. CARTON SIZE (INCH): 59,05 X 20,08 X 3,94</p>	<p>QUANTITY PER M. CARTON: 1</p> <p>M. CARTON WEIGHT (KG): 2,34</p> <p>M. CARTON WEIGHT (LBS): 5,15</p> <p>M. CARTON SIZE (M): 0,38 X 0,34 X 0,19</p> <p>M. CARTON SIZE (INCH): 14,96 X 13,39 X 7,48</p>	



► UNIT WAKEBOARD BINDINGS

**MADDOX WAKEBOARD 142 & UNIT BINDINGS SET**

ITEM NUMBER	EAN CODE	HS CODE	FEATURES
278819036	3/6 8718181017503 7/10 8718181017510 10/12 8718181017497	95062900	<p><b>BOARD</b>                      TRADITIONAL FOAM CORE                      HIGH PRESS FIBERGLASS MOLDED                      3-STAGE ROCKER                      DEEP GROOVED CHANNELS FOR TRACTION AND CONTROL                      BASE BOARD: EVERYTHING YOU NEED FOR AWESOMESS (FOR A GREAT PRICE)</p> <p><b>BINDINGS</b>                      ADJUSTABLE SHOE SIZES                      STRETCHY FLEX PANELS TO CONTROL YOUR RIDE                      SINGLE LACE PERFECT WRAPPED FIT                      CUSTOM JOBE LACE LOCK TO SECURE YOUR RIDE.</p>
<b>SIZE</b>	<b>CARTON INFO BOARD</b>	<b>CARTON INFO BINDING</b>	
3/6   7/10   10/12	QUANTITY PER M. CARTON: 1 M. CARTON WEIGHT (KG): 1 M. CARTON WEIGHT (LBS): 14,3 M. CARTON SIZE (M): 1,5 X 0,51 X 0,1 M. CARTON SIZE (INCH): 59,05 X 20,08 X 3,94	QUANTITY PER M. CARTON: 1 M. CARTON WEIGHT (KG): 2,34 M. CARTON WEIGHT (LBS): 5,15 M. CARTON SIZE (M): 0,38 X 0,34 X 0,19 M. CARTON SIZE (INCH): 14,96 X 13,39 X 7,48	



► REPUBLIK WAKEBOARD BINDINGS

### MADDOX WAKEBOARD 138 & REPUBLIK BINDINGS SET

ITEM NUMBER	EAN CODE	HS CODE	FEATURES
278819033	3/6 8718181017411 7/10 8718181017428 10/12 8718181017404	95062900	<p><b>BOARD</b></p> <p>TRADITIONAL FOAM CORE   HIGH PRESS FIBERGLASS MOLDED 3-STAGE ROCKER DEEP GROOVED CHANNELS FOR TRACTION AND CONTROL BASE BOARD: EVERYTHING YOU NEED FOR AWESOMESS (FOR A GREAT PRICE)</p>
<b>SIZE</b>			
3/6   7/10   10/12	<p><b>CARTON INFO BOARD</b></p> <p>QUANTITY PER M. CARTON: 1 M. CARTON WEIGHT (KG): 1 M. CARTON WEIGHT (LBS): 14,3 M. CARTON SIZE (M): 1,5 X 0,51 X 0,1 M. CARTON SIZE (INCH): 59,05 X 20,08 X 3,94</p>	<p><b>CARTON INFO BINDING</b></p> <p>QUANTITY PER M. CARTON: 1 M. CARTON WEIGHT (KG): 2,86 M. CARTON WEIGHT (LBS): 6,29 M. CARTON SIZE (M): 0,30 X 0,15 X 0,12 M. CARTON SIZE (INCH): 11,81 X 5,90 X 4,72</p>	<p><b>BINDINGS</b></p> <p>ADJUSTABLE SHOE SIZES   COMFORTABLE ERGONOMIC FOOT BED SOFT HEEL PADS FOR PROPER FOOT PLACEMENT SOFT AND COMFORTABLE FOAM INNER LINER STRETCHY FLEX PANELS TO CONTROL YOUR RIDE</p>



► REPUBLIK WAKEBOARD BINDINGS

**MADDOX WAKEBOARD 142 & REPUBLIK BINDINGS SET**

ITEM NUMBER	EAN CODE	HS CODE	FEATURES
278819034	3/6 8718181017442 7/10 8718181017459 10/12 8718181017455	95062900	<p><b>BOARD</b></p> <p>TRADITIONAL FOAM CORE   HIGH PRESS FIBERGLASS MOLDED 3-STAGE ROCKER DEEP GROOVED CHANNELS FOR TRACTION AND CONTROL BASE BOARD: EVERYTHING YOU NEED FOR AWESOMESS (FOR A GREAT PRICE)</p>
<b>SIZE</b>			
3/6   7/10   10/12			
	<b>CARTON INFO BOARD</b>	<b>CARTON INFO BINDING</b>	
	<p>QUANTITY PER M. CARTON: 1 M. CARTON WEIGHT (KG): 1 M. CARTON WEIGHT (LBS): 14,3 M. CARTON SIZE (M): 1,5 X 0,51 X 0,1 M. CARTON SIZE (INCH): 59,05 X 20,08 X 3,94</p>	<p>QUANTITY PER M. CARTON: 1 M. CARTON WEIGHT (KG): 2,86 M. CARTON WEIGHT (LBS): 6,29 M. CARTON SIZE (M): 0,30 X 0,15 X 0,12 M. CARTON SIZE (INCH): 11,81 X 5,90 X 4,72</p>	<p><b>BINDINGS</b></p> <p>ADJUSTABLE SHOE SIZES   COMFORTABLE ERGONOMIC FOOT BED SOFT HEEL PADS FOR PROPER FOOT PLACEMENT SOFT AND COMFORTABLE FOAM INNER LINER STRETCHY FLEX PANELS TO CONTROL YOUR RIDE</p>





► HOST WAKEBOARD BINDINGS BLACK

**PROLIX WAKEBOARD 134 & HOST BINDINGS BLACK SET**

ITEM NUMBER	EAN CODE	HS CODE	FEATURES
278819037	3/6 8718181017534 7/10 8718181017541 10/12 8718181017527	95062900	<p><b>BOARD</b>                      TRADITIONAL FOAM CORE   HIGH PRESS FIBERGLASS MOLDED HYBRID ROCKER   HIGH IMPACT BASE MATERIAL                      SMOOTH GROOVED CHANNELS FOR TRACTION AND CONTROL                      BASE BOARD: EVERYTHING YOU NEED FOR AWESOMESS (FOR A GREAT PRICE)</p> <p><b>BINDINGS</b>                      ADJUSTABLE SHOE SIZES   COMFORTABLE ERGONOMIC FOOT BED   SOFT HEEL PADS FOR PROPER FOOT PLACEMENT                      SOFT AND COMFORTABLE FOAM INNER LINER                      STRETCHY FLEX PANELS TO CONTROL YOUR RIDE                      USER FRIENDLY VELCRO STRAPS FOR A FAST ENTRY</p>
<b>SIZE</b>	<b>CARTON INFO BOARD</b>	<b>CARTON INFO BINDING</b>	
3/6   7/10   10/12	QUANTITY PER M. CARTON: 1 M. CARTON WEIGHT (KG): 1 M. CARTON WEIGHT (LBS): 14,3 M. CARTON SIZE (M): 1,5 X 0,51 X 0,1 M. CARTON SIZE (INCH): 59,05 X 20,08 X 3,94	QUANTITY PER M. CARTON: 1 M. CARTON WEIGHT (KG): 2,76 M. CARTON WEIGHT (LBS): 6,07 M. CARTON SIZE (M): 0,37 X 0,33 X 0,18 M. CARTON SIZE (INCH): 14,57 X 12,99 X 7,09	



► HOST WAKEBOARD BINDINGS BLACK

**PROLIX WAKEBOARD 138 & HOST BINDINGS BLACK SET**

ITEM NUMBER	EAN CODE	HS CODE	FEATURES
278819038	3/6 8718181017565 7/10 8718181017572 10/12 8718181017558	95062900	<p><b>BOARD</b>                      TRADITIONAL FOAM CORE   HIGH PRESS FIBERGLASS MOLDED HYBRID ROCKER   HIGH IMPACT BASE MATERIAL                      SMOOTH GROOVED CHANNELS FOR TRACTION AND CONTROL                      BASE BOARD: EVERYTHING YOU NEED FOR AWESOMESS (FOR A GREAT PRICE)</p> <p><b>BINDINGS</b>                      ADJUSTABLE SHOE SIZES   COMFORTABLE ERGONOMIC FOOT BED                      SOFT HEEL PADS FOR PROPER FOOT PLACEMENT                      SOFT AND COMFORTABLE FOAM INNER LINER                      STRETCHY FLEX PANELS TO CONTROL YOUR RIDE                      USER FRIENDLY VELCRO STRAPS FOR A FAST ENTRY</p>
<b>SIZE</b>	<b>CARTON INFO BOARD</b>	<b>CARTON INFO BINDING</b>	
3/6   7/10   10/12	QUANTITY PER M. CARTON: 1 M. CARTON WEIGHT (KG): 1 M. CARTON WEIGHT (LBS): 14,3 M. CARTON SIZE (M): 1,5 X 0,51 X 0,1 M. CARTON SIZE (INCH): 59,05 X 20,08 X 3,94	QUANTITY PER M. CARTON: 1 M. CARTON WEIGHT (KG): 2,76 M. CARTON WEIGHT (LBS): 6,07 M. CARTON SIZE (M): 0,37 X 0,33 X 0,18 M. CARTON SIZE (INCH): 14,57 X 12,99 X 7,09	



► HOST WAKEBOARD BINDINGS BLACK

**PROLIX WAKEBOARD 143 & HOST BINDINGS BLACK SET**

ITEM NUMBER	EAN CODE	HS CODE	FEATURES
278819039	3/6 8718181017602 7/10 8718181017619 10/12 8718181017589	95062900	<p><b>BOARD</b>                      TRADITIONAL FOAM CORE   HIGH PRESS FIBERGLASS MOLDED HYBRID ROCKER   HIGH IMPACT BASE MATERIAL                      SMOOTH GROOVED CHANNELS FOR TRACTION AND CONTROL                      BASE BOARD: EVERYTHING YOU NEED FOR AWESOMESS (FOR A GREAT PRICE)</p> <p><b>BINDINGS</b>                      ADJUSTABLE SHOE SIZES   COMFORTABLE ERGONOMIC FOOT BED                      SOFT HEEL PADS FOR PROPER FOOT PLACEMENT                      SOFT AND COMFORTABLE FOAM INNER LINER                      STRETCHY FLEX PANELS TO CONTROL YOUR RIDE                      USER FRIENDLY VELCRO STRAPS FOR A FAST ENTRY</p>
<b>SIZE</b>	<b>CARTON INFO BOARD</b>	<b>CARTON INFO BINDING</b>	
3/6   7/10   10/12	QUANTITY PER M. CARTON: 1 M. CARTON WEIGHT (KG): 1 M. CARTON WEIGHT (LBS): 14,3 M. CARTON SIZE (M): 1,5 X 0,51 X 0,1 M. CARTON SIZE (INCH): 59,05 X 20,08 X 3,94	QUANTITY PER M. CARTON: 1 M. CARTON WEIGHT (KG): 2,76 M. CARTON WEIGHT (LBS): 6,07 M. CARTON SIZE (M): 0,37 X 0,33 X 0,18 M. CARTON SIZE (INCH): 14,57 X 12,99 X 7,09	



► NITRO WAKEBOARD BINDINGS BLACK

**MADDOX WAKEBOARD 138 & NITRO BINDINGS BLACK SET**

ITEM NUMBER	EAN CODE	HS CODE	FEATURES
278819031	7/8 8718181017350 8/9.5 8718181017367 10/11 8718181017343	95062900	<p><b>BOARD</b></p> <p>TRADITIONAL FOAM CORE HIGH PRESS FIBERGLASS MOLDED 3-STAGE ROCKER DEEP GROOVED CHANNELS FOR TRACTION AND CONTROL BASE BOARD: EVERYTHING YOU NEED FOR AWESOMESS (FOR A GREAT PRICE)</p> <p><b>BINDINGS</b></p> <p>ADJUSTABLE SHOE SIZES COMFORTABLE ERGONOMIC FOOTBED SOFT HEEL PADS FOR PROPER FOOT PLACEMENT SOFT AND COMFORTABLE FOAM INNER LINER</p>
<b>SIZE</b>			
7/8   8/9.5   10/11	<p><b>CARTON INFO BOARD</b></p> <p>QUANTITY PER M. CARTON: 1 M. CARTON WEIGHT (KG): 1 M. CARTON WEIGHT (LBS): 14,3 M. CARTON SIZE (M): 1,5 X 0,51 X 0,1 M. CARTON SIZE (INCH): 59,05 X 20,08 X 3,94</p>	<p><b>CARTON INFO BINDING</b></p> <p>QUANTITY PER M. CARTON: 1 M. CARTON WEIGHT (KG): 2,66 M. CARTON WEIGHT (LBS): 5,85 M. CARTON SIZE (M): 0,37 X 0,32 X 0,19 M. CARTON SIZE (INCH): 14,57 X 12,60 X 7,48</p>	



► NITRO WAKEBOARD BINDINGS BLACK

**MADDOX WAKEBOARD 142 & NITRO BINDINGS BLACK SET**

ITEM NUMBER	EAN CODE	HS CODE	FEATURES
278819032	7/8 8718181017381 8/9.5 8718181017398 10/11 8718181017374	95062900	<p><b>BOARD</b></p> <p>TRADITIONAL FOAM CORE HIGH PRESS FIBERGLASS MOLDED 3-STAGE ROCKER DEEP GROOVED CHANNELS FOR TRACTION AND CONTROL BASE BOARD: EVERYTHING YOU NEED FOR AWESOMESS (FOR A GREAT PRICE)</p> <p><b>BINDINGS</b></p> <p>ADJUSTABLE SHOE SIZES COMFORTABLE ERGONOMIC FOOTBED SOFT HEEL PADS FOR PROPER FOOT PLACEMENT SOFT AND COMFORTABLE FOAM INNER LINER</p>
<b>SIZE</b>	<b>CARTON INFO BOARD</b>	<b>CARTON INFO BINDING</b>	
7/8   8/9.5   10/11	<p>QUANTITY PER M. CARTON: 1</p> <p>M. CARTON WEIGHT (KG): 1</p> <p>M. CARTON WEIGHT (LBS): 14,3</p> <p>M. CARTON SIZE (M): 1,5 X 0,51 X 0,1</p> <p>M. CARTON SIZE (INCH): 59,05 X 20,08 X 3,94</p>	<p>QUANTITY PER M. CARTON: 1</p> <p>M. CARTON WEIGHT (KG): 2,66</p> <p>M. CARTON WEIGHT (LBS): 5,85</p> <p>M. CARTON SIZE (M): 0,37 X 0,32 X 0,19</p> <p>M. CARTON SIZE (INCH): 14,57 X 12,60 X 7,48</p>	



► REPUBLIK WAKEBOARD BINDINGS

**KNOX WAKEBOARD 139 & REPUBLIK BINDINGS SET**

ITEM NUMBER	EAN CODE	HS CODE	FEATURES
278819029	3/6 8718181017299 7/10 8718181017305 10/12 8718181017282	95062900	<p><b>BOARD</b></p> <p>LIGHT WEIGHT WOOD FOAM CORE. HIGH PRESS FIBERGLASS MOLDED 3-STAGE ROCKER DEEP GROOVED CHANNELS FOR TRACTION AND CONTROL BASE BOARD: EVERYTHING YOU NEED TO BE AWESOME</p> <p><b>BINDINGS</b></p> <p>ADJUSTABLE SHOE SIZES COMFORTABLE ERGONOMIC FOOT BED SOFT HEEL PADS FOR PROPER FOOT PLACEMENT SOFT AND COMFORTABLE FOAM INNER LINER STRETCHY FLEX PANELS TO CONTROL YOUR RIDE</p>
<b>SIZE</b>	<b>CARTON INFO BOARD</b>	<b>CARTON INFO BINDING</b>	
3/6   7/10   10/12	<p>QUANTITY PER M. CARTON: 1</p> <p>M. CARTON WEIGHT (KG): 1</p> <p>M. CARTON WEIGHT (LBS): 14,3</p> <p>M. CARTON SIZE (M): 1,5 X 0,51 X 0,1</p> <p>M. CARTON SIZE (INCH): 59,05 X 20,08 X 3,94</p>	<p>QUANTITY PER M. CARTON: 1</p> <p>M. CARTON WEIGHT (KG): 2,86</p> <p>M. CARTON WEIGHT (LBS): 6,29</p> <p>M. CARTON SIZE (M): 0,30 X 0,15 X 0,12</p> <p>M. CARTON SIZE (INCH): 11,81 X 5,90 X 4,72</p>	



► REPUBLIK WAKEBOARD BINDINGS

### KNOX WAKEBOARD 143 & REPUBLIK BINDINGS SET

ITEM NUMBER	EAN CODE	HS CODE	FEATURES
278819030	3/6 8718181017329 7/10 8718181017336 10/12 8718181017312	95062900	<b>BOARD</b> LIGHT WEIGHT WOOD FOAM CORE. HIGH PRESS FIBERGLASS MOLDED 3-STAGE ROCKER DEEP GROOVED CHANNELS FOR TRACTION AND CONTROL BASE BOARD: EVERYTHING YOU NEED TO BE AWESOME
<b>SIZE</b>			<b>BINDINGS</b> ADJUSTABLE SHOE SIZES COMFORTABLE ERGONOMIC FOOT BED SOFT HEEL PADS FOR PROPER FOOT PLACEMENT SOFT AND COMFORTABLE FOAM INNER LINER STRETCHY FLEX PANELS TO CONTROL YOUR RIDE
3/6   7/10   10/12	<b>CARTON INFO BOARD</b> QUANTITY PER M. CARTON: 1 M. CARTON WEIGHT (KG): 1 M. CARTON WEIGHT (LBS): 14,3 M. CARTON SIZE (M): 1,5 X 0,51 X 0,1 M. CARTON SIZE (INCH): 59,05 X 20,08 X 3,94	<b>CARTON INFO BINDING</b> QUANTITY PER M. CARTON: 1 M. CARTON WEIGHT (KG): 2,86 M. CARTON WEIGHT (LBS): 6,29 M. CARTON SIZE (M): 0,30 X 0,15 X 0,12 M. CARTON SIZE (INCH): 11,81 X 5,90 X 4,72	



► NITRO WAKEBOARD BINDINGS COOL GREY

**KNOX WAKEBOARD PREMIUM 139 & NITRO BINDINGS COOL GREY SET**

ITEM NUMBER	EAN CODE	HS CODE	FEATURES
278819007	7/8 8718181016292 8/9.5 8718181016308 10/11 8718181016285	95062900	<p><b>BOARD</b></p> <p>LIGHTWEIGHT WOOD FOAM CORE. 3-STAGE ROCKER HIGH IMPACT BASE MATERIAL ROCKER BEAMS FOR CENTER STIFFNESS PREMIUM BOARD FINISH</p>
<b>SIZE</b>			
7/8   8/9.5   10/11	<p><b>CARTON INFO BOARD</b></p> <p>QUANTITY PER M. CARTON: 1 M. CARTON WEIGHT (KG): 1 M. CARTON WEIGHT (LBS): 14,3 M. CARTON SIZE (M): 1,5 X 0,51 X 0,1 M. CARTON SIZE (INCH): 59,05 X 20,08 X 3,94</p>	<p><b>CARTON INFO BINDING</b></p> <p>QUANTITY PER M. CARTON: 1 M. CARTON WEIGHT (KG): 2,66 M. CARTON WEIGHT (LBS): 5,85 M. CARTON SIZE (M): 0,37 X 0,32 X 0,19 M. CARTON SIZE (INCH): 14,57 X 12,60 X 7,48</p>	<p><b>BINDINGS</b></p> <p>ADJUSTABLE SHOE SIZES COMFORTABLE ERGONOMIC FOOTBED SOFT HEEL PADS FOR PROPER FOOT PLACEMENT SOFT AND COMFORTABLE FOAM INNER LINER</p>





► NITRO WAKEBOARD BINDINGS COOL GREY

### KNOX WAKEBOARD PREMIUM 143 & NITRO BINDINGS COOL GREY SET

ITEM NUMBER	EAN CODE	HS CODE	FEATURES
278819008	7/8 8718181016322 8/9.5 8718181016339 10/11 8718181016315	95062900	<b>BOARD</b> LIGHTWEIGHT WOOD FOAM CORE. 3-STAGE ROCKER HIGH IMPACT BASE MATERIAL ROCKER BEAMS FOR CENTER STIFFNESS PREMIUM BOARD FINISH
<b>SIZE</b>			
7/8   8/9.5   10/11	<b>CARTON INFO BOARD</b> QUANTITY PER M. CARTON: 1 M. CARTON WEIGHT (KG): 1 M. CARTON WEIGHT (LBS): 14,3 M. CARTON SIZE (M): 1,5 X 0,51 X 0,1 M. CARTON SIZE (INCH): 59,05 X 20,08 X 3,94	<b>CARTON INFO BINDING</b> QUANTITY PER M. CARTON: 1 M. CARTON WEIGHT (KG): 2,66 M. CARTON WEIGHT (LBS): 5,85 M. CARTON SIZE (M): 0,37 X 0,32 X 0,19 M. CARTON SIZE (INCH): 14,57 X 12,60 X 7,48	<b>BINDINGS</b> ADJUSTABLE SHOE SIZES COMFORTABLE ERGONOMIC FOOTBED SOFT HEEL PADS FOR PROPER FOOT PLACEMENT SOFT AND COMFORTABLE FOAM INNER LINER



► NITRO WAKEBOARD BINDINGS BLACK

**PROLIX WAKEBOARD PREMIUM 138 & NITRO BINDINGS BLACK SET**

ITEM NUMBER	EAN CODE	HS CODE	FEATURES
278819011	7/8 8718181016414 8/9.5 8718181016421 10/11 8718181016407	95062900	<p><b>BOARD</b></p> <p>TRADITIONAL FOAM CORE HYBRID ROCKER HIGH IMPACT BASE MATERIAL WOOD VENEER LAYER FOR STIFFNESS AND DURABILITY PREMIUM BOARD FINISH</p>
<b>SIZE</b>			
7/8   8/9.5   10/11	<p><b>CARTON INFO BOARD</b></p> <p>QUANTITY PER M. CARTON: 1 M. CARTON WEIGHT (KG): 1 M. CARTON WEIGHT (LBS): 14,3 M. CARTON SIZE (M): 1,5 X 0,51 X 0,1 M. CARTON SIZE (INCH): 59,05 X 20,08 X 3,94</p>	<p><b>CARTON INFO BINDING</b></p> <p>QUANTITY PER M. CARTON: 1 M. CARTON WEIGHT (KG): 2,66 M. CARTON WEIGHT (LBS): 5,85 M. CARTON SIZE (M): 0,37 X 0,32 X 0,19 M. CARTON SIZE (INCH): 14,57 X 12,60 X 7,48</p>	<p><b>BINDINGS</b></p> <p>ADJUSTABLE SHOE SIZES COMFORTABLE ERGONOMIC FOOTBED SOFT HEEL PADS FOR PROPER FOOT PLACEMENT SOFT AND COMFORTABLE FOAM INNER LINER</p>



► NITRO WAKEBOARD BINDINGS BLACK

### PROLIX WAKEBOARD PREMIUM 143 & NITRO BINDINGS BLACK SET

ITEM NUMBER	EAN CODE	HS CODE	FEATURES
278819012	7/8 8718181016445 8/9.5 8718181016452 10/11 8718181016438	95062900	<b>BOARD</b> TRADITIONAL FOAM CORE HYBRID ROCKER HIGH IMPACT BASE MATERIAL WOOD VENEER LAYER FOR STIFFNESS AND DURABILITY PREMIUM BOARD FINISH
<b>SIZE</b>			
7/8   8/9.5   10/11	<b>CARTON INFO BOARD</b> QUANTITY PER M. CARTON: 1 M. CARTON WEIGHT (KG): 1 M. CARTON WEIGHT (LBS): 14,3 M. CARTON SIZE (M): 1,5 X 0,51 X 0,1 M. CARTON SIZE (INCH): 59,05 X 20,08 X 3,94	<b>CARTON INFO BINDING</b> QUANTITY PER M. CARTON: 1 M. CARTON WEIGHT (KG): 2,66 M. CARTON WEIGHT (LBS): 5,85 M. CARTON SIZE (M): 0,37 X 0,32 X 0,19 M. CARTON SIZE (INCH): 14,57 X 12,60 X 7,48	<b>BINDINGS</b> ADJUSTABLE SHOE SIZES COMFORTABLE ERGONOMIC FOOTBED SOFT HEEL PADS FOR PROPER FOOT PLACEMENT SOFT AND COMFORTABLE FOAM INNER LINER



► NITRO WAKEBOARD BINDINGS BLACK

**MADDOX WAKEBOARD PREMIUM 138 & NITRO BINDINGS BLACK SET**

ITEM NUMBER	EAN CODE	HS CODE	FEATURES
278819009	7/8 8718181016353 8/9.5 8718181016360 10/11 8718181016346	95062900	<p><b>BOARD</b></p> <p>TRADITIONAL FOAM CORE 3-STAGE ROCKER HIGH IMPACT BASE MATERIAL WOOD VENEER LAYER FOR STIFFNESS AND DURABILITY PREMIUM BOARD FINISH</p>
<b>SIZE</b>			
7/8   8/9.5   10/11	<p><b>CARTON INFO BOARD</b></p> <p>QUANTITY PER M. CARTON: 1 M. CARTON WEIGHT (KG): 1 M. CARTON WEIGHT (LBS): 14,3 M. CARTON SIZE (M): 1,5 X 0,51 X 0,1 M. CARTON SIZE (INCH): 59,05 X 20,08 X 3,94</p>	<p><b>CARTON INFO BINDING</b></p> <p>QUANTITY PER M. CARTON: 1 M. CARTON WEIGHT (KG): 2,66 M. CARTON WEIGHT (LBS): 5,85 M. CARTON SIZE (M): 0,37 X 0,32 X 0,19 M. CARTON SIZE (INCH): 14,57 X 12,60 X 7,48</p>	<p><b>BINDINGS</b></p> <p>ADJUSTABLE SHOE SIZES COMFORTABLE ERGONOMIC FOOTBED SOFT HEEL PADS FOR PROPER FOOT PLACEMENT SOFT AND COMFORTABLE FOAM INNER LINER</p>



► NITRO WAKEBOARD BINDINGS BLACK

### MADDOX WAKEBOARD PREMIUM 142 & NITRO BINDINGS BLACK SET

ITEM NUMBER	EAN CODE	HS CODE	FEATURES
278819010	7/8 8718181016384 8/9.5 8718181016391 10/11 8718181016377	95062900	<b>BOARD</b> TRADITIONAL FOAM CORE 3-STAGE ROCKER HIGH IMPACT BASE MATERIAL WOOD VENEER LAYER FOR STIFFNESS AND DURABILITY PREMIUM BOARD FINISH
<b>SIZE</b>			
7/8   8/9.5   10/11	<b>CARTON INFO BOARD</b> QUANTITY PER M. CARTON: 1 M. CARTON WEIGHT (KG): 1 M. CARTON WEIGHT (LBS): 14,3 M. CARTON SIZE (M): 1,5 X 0,51 X 0,1 M. CARTON SIZE (INCH): 59,05 X 20,08 X 3,94	<b>CARTON INFO BINDING</b> QUANTITY PER M. CARTON: 1 M. CARTON WEIGHT (KG): 2,66 M. CARTON WEIGHT (LBS): 5,85 M. CARTON SIZE (M): 0,37 X 0,32 X 0,19 M. CARTON SIZE (INCH): 14,57 X 12,60 X 7,48	<b>BINDINGS</b> ADJUSTABLE SHOE SIZES COMFORTABLE ERGONOMIC FOOTBED SOFT HEEL PADS FOR PROPER FOOT PLACEMENT SOFT AND COMFORTABLE FOAM INNER LINER



► NITRO WAKEBOARD BINDINGS COOL GREY

**KNOX WAKEBOARD PREMIUM 139 & NITRO BINDINGS COOL GREY SET**

ITEM NUMBER	EAN CODE	HS CODE	FEATURES
278819007	7/8 8718181016292 8/9.5 8718181016308 10/11 8718181016285	95062900	<p><b>BOARD</b></p> <p>LIGHTWEIGHT WOOD FOAM CORE. 3-STAGE ROCKER HIGH IMPACT BASE MATERIAL ROCKER BEAMS FOR CENTER STIFFNESS PREMIUM BOARD FINISH</p>
<b>SIZE</b>			
7/8   8/9.5   10/11	<p><b>CARTON INFO BOARD</b></p> <p>QUANTITY PER M. CARTON: 1 M. CARTON WEIGHT (KG): 1 M. CARTON WEIGHT (LBS): 14,3 M. CARTON SIZE (M): 1,5 X 0,51 X 0,1 M. CARTON SIZE (INCH): 59,05 X 20,08 X 3,94</p>	<p><b>CARTON INFO BINDING</b></p> <p>QUANTITY PER M. CARTON: 1 M. CARTON WEIGHT (KG): 2,66 M. CARTON WEIGHT (LBS): 5,85 M. CARTON SIZE (M): 0,37 X 0,32 X 0,19 M. CARTON SIZE (INCH): 14,57 X 12,60 X 7,48</p>	<p><b>BINDINGS</b></p> <p>ADJUSTABLE SHOE SIZES COMFORTABLE ERGONOMIC FOOTBED SOFT HEEL PADS FOR PROPER FOOT PLACEMENT SOFT AND COMFORTABLE FOAM INNER LINER</p>



► NITRO WAKEBOARD BINDINGS COOL GREY

### KNOX WAKEBOARD PREMIUM 143 & NITRO BINDINGS COOL GREY SET

ITEM NUMBER	EAN CODE	HS CODE	FEATURES
278819008	7/8 8718181016322 8/9.5 8718181016339 10/11 8718181016315	95062900	<b>BOARD</b> LIGHTWEIGHT WOOD FOAM CORE. 3-STAGE ROCKER HIGH IMPACT BASE MATERIAL ROCKER BEAMS FOR CENTER STIFFNESS PREMIUM BOARD FINISH
<b>SIZE</b>			
7/8   8/9.5   10/11	<b>CARTON INFO BOARD</b> QUANTITY PER M. CARTON: 1 M. CARTON WEIGHT (KG): 1 M. CARTON WEIGHT (LBS): 14,3 M. CARTON SIZE (M): 1,5 X 0,51 X 0,1 M. CARTON SIZE (INCH): 59,05 X 20,08 X 3,94	<b>CARTON INFO BINDING</b> QUANTITY PER M. CARTON: 1 M. CARTON WEIGHT (KG): 2,66 M. CARTON WEIGHT (LBS): 5,85 M. CARTON SIZE (M): 0,37 X 0,32 X 0,19 M. CARTON SIZE (INCH): 14,57 X 12,60 X 7,48	<b>BINDINGS</b> ADJUSTABLE SHOE SIZES COMFORTABLE ERGONOMIC FOOTBED SOFT HEEL PADS FOR PROPER FOOT PLACEMENT SOFT AND COMFORTABLE FOAM INNER LINER



Nylon  
Glassezelslerkt 35%



# DRIFT SNEAKER TECHNOLOGY

---

COMFORTABLE LINER, SOFT AND SUPPORTIVE

SUPPORTIVE PE BACKSTRAY FOR DURABILITY AND STRENGTH



CUSTOM OUTSOLE  
EVA & RUBBER MIX

CUSTOM INSOLE FOR  
PERFECT SUPPORT

KIDNEY FOR  
A SNUG FIT

# DRIFT SKIN & BINDING TECHNOLOGY





► SNEAKERS



► BINDING



► SKIN

**PROLIX WAKEBOARD PREMIUM 138 & DRIFT BINDINGS SET**

**ITEM NUMBER**

278819005

**SIZE**

6 | 7 | 8 | 9 | 10 | 11

**EAN CODE**

6 8718181016179  
 7 8718181016193  
 8 8718181016209  
 9 8718181016216  
 10 8718181016155  
 11 8718181016162

**HS CODE**

95062900

**FEATURES**

**BOARD:**  
 TRADITIONAL FOAM CORE | HYBRID ROCKER |  
 HIGH IMPACT BASE MATERIAL | WOOD VENEER  
 LAYER FOR STIFFNESS AND DURABILITY |  
 PREMIUM BOARD FINISH

**SKIN:**  
 FLEXIBLE TPU TO CREATE THE PERFECT WRAP-  
 PED FIT | COMPRESSED EVA FOAM OPTIMIZES  
 THE INSIDE GRIP

**BINDINGS:**  
 STIFF NYLON FRAME WITH REINFORCED  
 FIBERGLASS | CENTERED MOUNTING RESULTS  
 IN DIRECT CONTROL | TAPERED FOOT BED TO  
 OPTIMIZE THE TOE CONTROL

**SNEAKER:**  
 EXTRA WATER DRAINS | QUICK-DRYING  
 MATERIALS | STIFF CONSTRUCTION

**CARTON INFO BOARD**

QUANTITY PER M. CARTON: 1  
 M. CARTON WEIGHT (KG): 6,5  
 M. CARTON WEIGHT (LBS): 14,3  
 M. CARTON SIZE (M): 1,5 X 0,51 X 0,1  
 M. CARTON SIZE (INCH): 59,05 X 20,08 X 3,94

**CARTON INFO SNEAKER**

QUANTITY PER M. CARTON: 1  
 M. CARTON WEIGHT (KG): 2,3  
 M. CARTON WEIGHT (LBS): 4,6  
 M. CARTON SIZE (M): 0,38 X 0,35 X 0,13  
 M. CARTON SIZE (INCH): 14,96 X 13,78 X 5,12

**CARTON INFO BINDING**

QUANTITY PER M. CARTON: 1  
 M. CARTON WEIGHT (KG): 1,71  
 M. CARTON WEIGHT (LBS): 3,76  
 M. CARTON SIZE (M): 0,19 X 0,34 X 0,17  
 M. CARTON SIZE (INCH): 7,48 X 13,39 X 6,69

**CARTON INFO SKIN**

QUANTITY PER M. CARTON: 1  
 M. CARTON WEIGHT (KG): 0,59  
 M. CARTON WEIGHT (LBS): 1,3  
 M. CARTON SIZE (M): 0,16 X 0,29 X 0,12  
 M. CARTON SIZE (INCH): 6,3 X 11,42 X 4,72



► SNEAKERS



► BINDING



► SKIN

**PROLIX WAKEBOARD PREMIUM 143 & DRIFT BINDINGS SET**

ITEM NUMBER	EAN CODE	FEATURES
278819006	6 8718181016247 7 8718181016254 8 8718181016261 9 8718181016278 10 8718181016223 11 8718181016230	BOARD: TRADITIONAL FOAM CORE   HYBRID ROCKER   HIGH IMPACT BASE MATERIAL   WOOD VENEER LAYER FOR STIFFNESS AND DURABILITY   PREMIUM BOARD FINISH  SKIN: FLEXIBLE TPU TO CREATE THE PERFECT WRAPPED FIT   COMPRESSED EVA FOAM OPTIMIZES THE INSIDE GRIP
<b>SIZE</b>	<b>HS CODE</b> 95062900	BINDING: STIFF NYLON FRAME WITH REINFORCED FIBER-GLASS   CENTERED MOUNTING RESULTS IN DIRECT CONTROL   TAPERED FOOT BED TO OPTIMIZE THE TOE CONTROL  SNEAKER: EXTRA WATER DRAINS   QUICK-DRYING MATERIALS   STIFF CONSTRUCTION

**CARTON INFO BOARD**

QUANTITY PER M. CARTON:	1
M. CARTON WEIGHT (KG):	6,5
M. CARTON WEIGHT (LBS):	14,3
M. CARTON SIZE (M):	1,5 X 0,51 X 0,1
M. CARTON SIZE (INCH):	59,05 X 20,08 X 3,94

**CARTON INFO SNEAKER**

QUANTITY PER M. CARTON:	1
M. CARTON WEIGHT (KG):	2,3
M. CARTON WEIGHT (LBS):	4,6
M. CARTON SIZE (M):	0,38 X 0,35 X 0,13
M. CARTON SIZE (INCH):	14,96 X 13,78 X 5,12

**CARTON INFO BINDING**

QUANTITY PER M. CARTON:	1
M. CARTON WEIGHT (KG):	1,71
M. CARTON WEIGHT (LBS):	3,76
M. CARTON SIZE (M):	0,19 X 0,34 X 0,17
M. CARTON SIZE (INCH):	7,48 X 13,39 X 6,69

**CARTON INFO SKIN**

QUANTITY PER M. CARTON:	1
M. CARTON WEIGHT (KG):	0,59
M. CARTON WEIGHT (LBS):	1,3
M. CARTON SIZE (M):	0,16 X 0,29 X 0,12
M. CARTON SIZE (INCH):	6,3 X 11,42 X 4,72



► SNEAKERS



► BINDING



► SKIN

**MADDOX WAKEBOARD PREMIUM 138 & DRIFT BINDINGS SET**

**ITEM NUMBER**

278819003

**SIZE**

6 | 7 | 8 | 9 | 10 | 11

**EAN CODE**

6 8718181016056  
 7 8718181016063  
 8 8718181016070  
 9 8718181016087  
 10 8718181016032  
 11 8718181016049

**HS CODE**

95062900

**FEATURES**

**BOARD:**  
 TOP RIDER AUSTIN HAIR HIS PROMODEL |  
 TRADITIONAL FOAM CORE | 3-STAGE ROCKER |  
 HIGH IMPACT BASE MATERIAL | WOOD VENEER  
 LAYER FOR STIFFNESS AND DURABILITY |  
 PREMIUM BOARD FINISH

**SKIN:**  
 FLEXIBLE TPU TO CREATE THE PERFECT WRAP-  
 PED FIT | COMPRESSED EVA FOAM OPTIMIZES  
 THE INSIDE GRIP

**BINDING:**  
 STIFF NYLON FRAME WITH REINFORCED  
 FIBERGLASS | CENTERED MOUNTING RESULTS  
 IN DIRECT CONTROL | TAPERED FOOT BED TO  
 OPTIMIZE THE TOE CONTROL

**SNEAKER:**  
 EXTRA WATER DRAINS | QUICK-DRYING  
 MATERIALS | STIFF CONSTRUCTION

**CARTON INFO BOARD**

QUANTITY PER M. CARTON: 1  
 M. CARTON WEIGHT (KG): 6,5  
 M. CARTON WEIGHT (LBS): 14,3  
 M. CARTON SIZE (M): 1,5 X 0,51 X 0,1  
 M. CARTON SIZE (INCH): 59,05 X 20,08 X 3,94

**CARTON INFO SNEAKER**

QUANTITY PER M. CARTON: 1  
 M. CARTON WEIGHT (KG): 2,3  
 M. CARTON WEIGHT (LBS): 4,6  
 M. CARTON SIZE (M): 0,38 X 0,35 X 0,13  
 M. CARTON SIZE (INCH): 14,96 X 13,78 X 5,12

**CARTON INFO BINDING**

QUANTITY PER M. CARTON: 1  
 M. CARTON WEIGHT (KG): 1,71  
 M. CARTON WEIGHT (LBS): 3,76  
 M. CARTON SIZE (M): 0,19 X 0,34 X 0,17  
 M. CARTON SIZE (INCH): 7,48 X 13,39 X 6,69

**CARTON INFO SKIN**

QUANTITY PER M. CARTON: 1  
 M. CARTON WEIGHT (KG): 0,59  
 M. CARTON WEIGHT (LBS): 1,3  
 M. CARTON SIZE (M): 0,16 X 0,29 X 0,12  
 M. CARTON SIZE (INCH): 6,3 X 11,42 X 4,72



► SNEAKERS



► BINDING



► SKIN

**MADDOX WAKEBOARD PREMIUM 142 & DRIFT BINDINGS SET**

**ITEM NUMBER**

278819004

**SIZE**

6 | 7 | 8 | 9 | 10 | 11

**EAN CODE**

6 8718181016117  
 7 8718181016124  
 8 8718181016131  
 9 8718181016148  
 10 8718181016094  
 11 8718181016100

**HS CODE**

95062900

**FEATURES**

**BOARD:**  
 TOP RIDER AUSTIN HAIR HIS PROMODEL |  
 TRADITIONAL FOAM CORE | 3-STAGE ROCKER |  
 HIGH IMPACT BASE MATERIAL | WOOD VENEER  
 LAYER FOR STIFFNESS AND DURABILITY |  
 PREMIUM BOARD FINISH

**SKIN:**  
 FLEXIBLE TPU TO CREATE THE PERFECT WRAP-  
 PED FIT | COMPRESSED EVA FOAM OPTIMIZES  
 THE INSIDE GRIP

**BINDING:**  
 STIFF NYLON FRAME WITH REINFORCED  
 FIBERGLASS | CENTERED MOUNTING RESULTS  
 IN DIRECT CONTROL | TAPERED FOOT BED TO  
 OPTIMIZE THE TOE CONTROL

**SNEAKER:**  
 EXTRA WATER DRAINS | QUICK-DRYING  
 MATERIALS | STIFF CONSTRUCTION

**CARTON INFO BOARD**

QUANTITY PER M. CARTON: 1  
 M. CARTON WEIGHT (KG): 6,5  
 M. CARTON WEIGHT (LBS): 14,3  
 M. CARTON SIZE (M): 1,5 X 0,51 X 0,1  
 M. CARTON SIZE (INCH): 59,05 X 20,08 X 3,94

**CARTON INFO SNEAKER**

QUANTITY PER M. CARTON: 1  
 M. CARTON WEIGHT (KG): 2,3  
 M. CARTON WEIGHT (LBS): 4,6  
 M. CARTON SIZE (M): 0,38 X 0,35 X 0,13  
 M. CARTON SIZE (INCH): 14,96 X 13,78 X 5,12

**CARTON INFO BINDING**

QUANTITY PER M. CARTON: 1  
 M. CARTON WEIGHT (KG): 1,71  
 M. CARTON WEIGHT (LBS): 3,76  
 M. CARTON SIZE (M): 0,19 X 0,34 X 0,17  
 M. CARTON SIZE (INCH): 7,48 X 13,39 X 6,69

**CARTON INFO SKIN**

QUANTITY PER M. CARTON: 1  
 M. CARTON WEIGHT (KG): 0,59  
 M. CARTON WEIGHT (LBS): 1,3  
 M. CARTON SIZE (M): 0,16 X 0,29 X 0,12  
 M. CARTON SIZE (INCH): 6,3 X 11,42 X 4,72



► SNEAKERS



► BINDING



► SKIN

**KNOX WAKEBOARD PREMIUM 139 & DRIFT BINDINGS SET**

**ITEM NUMBER**

278819088

**SIZE**

6 | 7 | 8 | 9 | 10 | 11

**EAN CODE**

6 8718181018869  
 7 8718181018876  
 8 8718181018890  
 9 8718181018906  
 10 8718181018845  
 11 8718181018852

**HS CODE**

95062900

**FEATURES**

**BOARD:**  
 LIGHTWEIGHT WOOD FOAM CORE | 3-STAGE  
 ROCKER | HIGH IMPACT BASE MATERIAL | ROCKER  
 BEAMS FOR CENTER STIFFNESS | EVERYTHING  
 YOU NEED FOR AWESOMESS (FOR A GREAT  
 PRICE)

**SKIN:**  
 FLEXIBLE TPU TO CREATE THE PERFECT WRAPPED  
 FIT | COMPRESSED EVA FOAM OPTIMIZES THE  
 INSIDE GRIP

**BINDING:**  
 STIFF NYLON FRAME WITH REINFORCED FIBER-  
 GLASS | CENTERED MOUNTING RESULTS IN DIRECT  
 CONTROL | TAPERED FOOT BED TO OPTIMIZE THE  
 TOE CONTROL

**SNEAKER:**  
 EXTRA WATER DRAINS | QUICK-DRYING MATERI-  
 ALS | STIFF CONSTRUCTION

**CARTON INFO BOARD**

QUANTITY PER M. CARTON: 1  
 M. CARTON WEIGHT (KG): 6,5  
 M. CARTON WEIGHT (LBS): 14,3  
 M. CARTON SIZE (M): 1,5 X 0,51 X 0,1  
 M. CARTON SIZE (INCH): 59,05 X 20,08 X 3,94

**CARTON INFO SNEAKER**

QUANTITY PER M. CARTON: 1  
 M. CARTON WEIGHT (KG): 2,3  
 M. CARTON WEIGHT (LBS): 4,6  
 M. CARTON SIZE (M): 0,38 X 0,35 X 0,13  
 M. CARTON SIZE (INCH): 14,96 X 13,78 X 5,12

**CARTON INFO BINDING**

QUANTITY PER M. CARTON: 1  
 M. CARTON WEIGHT (KG): 1,71  
 M. CARTON WEIGHT (LBS): 3,76  
 M. CARTON SIZE (M): 0,19 X 0,34 X 0,17  
 M. CARTON SIZE (INCH): 7,48 X 13,39 X 6,69

**CARTON INFO SKIN**

QUANTITY PER M. CARTON: 1  
 M. CARTON WEIGHT (KG): 0,59  
 M. CARTON WEIGHT (LBS): 1,3  
 M. CARTON SIZE (M): 0,16 X 0,29 X 0,12  
 M. CARTON SIZE (INCH): 6,3 X 11,42 X 4,72



► SNEAKERS



► BINDING



► SKIN

**KNOX WAKEBOARD PREMIUM 143 & DRIFT BINDINGS SET**

ITEM NUMBER	EAN CODE	FEATURES
278819002	6 8718181015998 7 8718181016001 8 8718181016018 9 8718181016025 10 8718181015974 11 8718181015981	BOARD: LIGHTWEIGHT WOOD FOAM CORE   3-STAGE ROCKER   HIGH IMPACT BASE MATERIAL   ROCKER BEAMS FOR CENTER STIFFNESS   PREMIUM BOARD FINISH  SKIN: FLEXIBLE TPU TO CREATE THE PERFECT WRAP- PED FIT   COMPRESSED EVA FOAM OPTIMIZES THE INSIDE GRIP
<b>SIZE</b>	<b>HS CODE</b>	BINDING: STIFF NYLON FRAME WITH REINFORCED FIBERGLASS   CENTERED MOUNTING RESULTS IN DIRECT CONTROL   TAPERED FOOT BED TO OPTIMIZE THE TOE CONTROL  SNEAKER: EXTRA WATER DRAINS   QUICK-DRYING MATERIALS   STIFF CONSTRUCTION
6   7   8   9   10   11	95062900	

**CARTON INFO BOARD**

QUANTITY PER M. CARTON:	1
M. CARTON WEIGHT (KG):	6,5
M. CARTON WEIGHT (LBS):	14,3
M. CARTON SIZE (M):	1,5 X 0,51 X 0,1
M. CARTON SIZE (INCH):	59,05 X 20,08 X 3,94

**CARTON INFO SNEAKER**

QUANTITY PER M. CARTON:	1
M. CARTON WEIGHT (KG):	2,3
M. CARTON WEIGHT (LBS):	4,6
M. CARTON SIZE (M):	0,38 X 0,35 X 0,13
M. CARTON SIZE (INCH):	14,96 X 13,78 X 5,12

**CARTON INFO BINDING**

QUANTITY PER M. CARTON:	1
M. CARTON WEIGHT (KG):	1,71
M. CARTON WEIGHT (LBS):	3,76
M. CARTON SIZE (M):	0,19 X 0,34 X 0,17
M. CARTON SIZE (INCH):	7,48 X 13,39 X 6,69

**CARTON INFO SKIN**

QUANTITY PER M. CARTON:	1
M. CARTON WEIGHT (KG):	0,59
M. CARTON WEIGHT (LBS):	1,3
M. CARTON SIZE (M):	0,16 X 0,29 X 0,12
M. CARTON SIZE (INCH):	6,3 X 11,42 X 4,72







**LOGO SERIES WAKEBOARD**

ITEM NUMBER	EAN CODE	HS CODE	FEATURES
272519011	138 8718181003773	95062900	TRADITIONAL FOAM CORE HIGH PRESS FIBERGLASS MOLDED MOLDED FINS 3-STAGE ROCKER DOUBLE CONCAVE BOTTOM DESIGN FOR SMOOTH LANDINGS 2 NYLON PLASTIC CENTER FINS BASE BOARD: EVERYTHING YOU NEED FOR AWESOMESS (FOR A GREAT PRICE)
SIZE	MASTER CARTON INFO		
138	QUANTITY PER M. CARTON: 1 M. CARTON WEIGHT (KG): 5,99 M. CARTON WEIGHT (LBS): 13,178 M. CARTON SIZE (M): 1,5X0,5X0,09 M. CARTON SIZE (INCH): 59,06X19,69X3,35		



**VANITY WAKEBOARD WOMEN**

ITEM NUMBER	EAN CODE	HS CODE	FEATURES
272519010	131 8718181003759 136 8718181003766	95062900	TRADITIONAL FOAM CORE HIGH PRESS FIBERGLASS MOLDED MOLDED FINS CONTINUOUS ROCKER DEEP GROOVED CHANNELS FOR TRACTION AND CONTROL 2 NYLON PLASTIC CENTER FINS. BASE BOARD: EVERYTHING YOU NEED FOR AWESOMESS (FOR A GREAT PRICE)
<b>SIZE</b>		<b>MASTER CARTON INFO</b>	
131   136		QUANTITY PER M. CARTON: 1 M. CARTON WEIGHT (KG): 5,6 M. CARTON WEIGHT (LBS): 12,32 M. CARTON SIZE (M): 1,36 X 0,5 X 0,09 M. CARTON SIZE (INCH): 53,54 X 19,69 X 3,35	



**VANITY WAKEBOARD**

ITEM NUMBER	EAN CODE	HS CODE	FEATURES
272519005	131 8718181003629	95062900	TRADITIONAL FOAM CORE HIGH PRESS FIBERGLASS MOLDED 2 NYLON PLASTIC FINS CONTINUOUS ROCKER DEEP GROOVED CHANNELS FOR TRACTION AND CONTROL MOLDED FINS
	136 8718181003636		BASE BOARD: EVERYTHING YOU NEED FOR AWESOMESS (FOR A GREAT PRICE)
	141 8718181003643		
SIZE	MASTER CARTON INFO		
131   136   141	QUANTITY PER M. CARTON: 1 M. CARTON WEIGHT (KG): 5,71 M. CARTON WEIGHT (LBS): 12,562 M. CARTON SIZE (M): 1,36 X 0,5 X 0,09 M. CARTON SIZE (INCH): 53,54 X 19,69 X 3,35		



**PROLIX WAKEBOARD**

ITEM NUMBER	EAN CODE	HS CODE	FEATURES
272519008	134 8718181003704	95062900	TRADITIONAL FOAM CORE HIGH PRESS FIBERGLASS MOLDED HYBRID ROCKER HIGH IMPACT BASE MATERIAL 4 NYLON PLASTIC FINS SMOOTH GROOVED CHANNELS FOR TRACTION AND CONTROL ROLLED EDGE FOR EXTRA DURABILITY BASE BOARD: EVERYTHING YOU NEED FOR AWESOMESS (FOR A GREAT PRICE)
	138 8718181003711		
	143 8718181003728		
SIZE	MASTER CARTON INFO		
134   138   143	QUANTITY PER M. CARTON:	1	
	M. CARTON WEIGHT (KG):	5,99	
	M. CARTON WEIGHT (LBS):	13,178	
	M. CARTON SIZE (M):	1,5 X 0,5 X 0,09	
	M. CARTON SIZE (INCH):	59,06 X 19,69 X 3,35	



**MADDOX WAKEBOARD**

ITEM NUMBER	EAN CODE	HS CODE	FEATURES
272519007	138 8718181003674 142 8718181003681	95062900	TOP RIDER AUSTIN HAIR HIS PROMODEL TRADITIONAL FOAM CORE HIGH PRESS FIBERGLASS MOLDED 3-STAGE ROCKER 4 NYLON PLASTIC FINS DEEP GROOVED CHANNELS FOR TRACTION AND CONTROL BASE BOARD: EVERYTHING YOU NEED FOR AWESOMESS (FOR A GREAT PRICE)
<b>SIZE</b>		<b>MASTER CARTON INFO</b>	
138   142		QUANTITY PER M. CARTON: 1 M. CARTON WEIGHT (KG): 6,25 M. CARTON WEIGHT (LBS): 13,75 M. CARTON SIZE (M): 15X0,5X0,09 M. CARTON SIZE (INCH): 59,06X19,69X3,35	



**KNOX WAKEBOARD**

ITEM NUMBER	EAN CODE	HS CODE	FEATURES
272519006	139 8718181003650 143 8718181003667	95062900	LIGHTWEIGHT WOOD FOAM CORE. ABS PROTECTING SIDEWALLS HIGH PRESS FIBERGLASS MOLDED FLEX CONSTRUCTION 3-STAGE ROCKER 4 NYLON PLASTIC FINS DEEP GROOVED CHANNELS FOR TRACTION AND CONTROL BASE BOARD: EVERYTHING YOU NEED FOR AWESOMESS (FOR A GREAT PRICE)
<b>SIZE</b>		<b>MASTER CARTON INFO</b>	
139   143		QUANTITY PER M. CARTON: 1 M. CARTON WEIGHT (KG): 5,78 M. CARTON WEIGHT (LBS): 12,716 M. CARTON SIZE (M): 1,5X0,5X0,09 M. CARTON SIZE (INCH): 59,06X19,69X3,35	



**PROLIX WAKEBOARD PREMIUM**

ITEM NUMBER	EAN CODE	HS CODE	FEATURES
272319003	138 8718181000987 143 8718181003513	95062900	TRADITIONAL FOAM CORE HIGH PRESS FIBERGLASS MOLDED HYBRID ROCKER HIGH IMPACT BASE MATERIAL 4 NYLON PLASTIC FINS SMOOTH GROOVED CHANNELS FOR TRACTION AND CONTROL WOOD VENEER LAYER FOR STIFFNESS AND DURABILITY ROLLED EDGE FOR EXTRA DURABILITY
SIZE	<b>MASTER CARTON INFO</b>		
138   143	QUANTITY PER M. CARTON: 1 M. CARTON WEIGHT (KG): 6,25 M. CARTON WEIGHT (LBS): 13,75 M. CARTON SIZE (M): 1,5X0,5X0,09 M. CARTON SIZE (INCH): 59,06X19,69X3,35		



**MADDOX WAKEBOARD PREMIUM**

ITEM NUMBER	EAN CODE	HS CODE	FEATURES
272319002	138 8718181003490 142 8718181003506	95062900	TOP WORLD RIDER' AUSTIN HAIR HIS PRO MODEL TRADITIONAL FOAM CORE HIGH PRESS FIBERGLASS MOLDED 3-STAGE ROCKER HIGH IMPACT BASE MATERIAL 4 NYLON PLASTIC FINS DEEP GROOVED CHANNELS FOR TRACTION AND CONTROL WOOD VENEER LAYER FOR STIFFNESS AND DURABILITY
<b>SIZE</b>		<b>MASTER CARTON INFO</b>	
138   142		QUANTITY PER M. CARTON: 1 M. CARTON WEIGHT (KG): 6,25 M. CARTON WEIGHT (LBS): 13,75 M. CARTON SIZE (M): 1,5X0,5X0,09 M. CARTON SIZE (INCH): 59,06X19,69X3,35	



JOBESPORTS.COM | PAGE 418

**KNOX WAKEBOARD PREMIUM**

ITEM NUMBER	EAN CODE	HS CODE	FEATURES
272319001	139 8718181003483 143 8718181000970	95062900	LIGHTWEIGHT WOOD FOAM CORE ABS PROTECTING SIDEWALLS HIGH PRESS FIBERGLASS MOLDED 4 NYLON PLASTIC FINS FLEX CONSTRUCTION 3-STAGE ROCKER HIGH IMPACT BASE MATERIAL ROCKER BEAMS FOR CENTER STIFFNESS DEEP GROOVED CHANNELS FOR TRACTION AND CONTROL
SIZE	MASTER CARTON INFO		
139   143	QUANTITY PER M. CARTON: 1 M. CARTON WEIGHT (KG): 5,96 M. CARTON WEIGHT (LBS): 13,112 M. CARTON SIZE (M): 1,5X0,5X0,09 M. CARTON SIZE (INCH): 59,06X19,69X3,35		



► NITRO WAKEBOARD BINDINGS BLACK

### PITCH WAKEBOARD 136 & NITRO BINDINGS BLACK SET

ITEM NUMBER	EAN CODE	HS CODE	FEATURES
278819080	7/8 8718181018715 8/9.5 8718181018722 10/11 8718181018708	95062900	<b>BOARD</b> FULL WOOD DURABLE CORE. FLEX CONSTRUCTION CONTINUOUS ROCKER HIGH IMPACT BASE MATERIAL
<b>SIZE</b>			
7/8   8/9.5   10/11	<b>CARTON INFO BOARD</b> QUANTITY PER M. CARTON: 1 M. CARTON WEIGHT (KG): 1 M. CARTON WEIGHT (LBS): 14,3 M. CARTON SIZE (M): 1,5 X 0,51 X 0,1 M. CARTON SIZE (INCH): 59,05 X 20,08 X 3,94	<b>CARTON INFO BINDING</b> QUANTITY PER M. CARTON: 1 M. CARTON WEIGHT (KG): 2,66 M. CARTON WEIGHT (LBS): 5,85 M. CARTON SIZE (M): 0,37 X 0,32 X 0,19 M. CARTON SIZE (INCH): 14,57 X 12,60 X 7,48	<b>BINDINGS</b> ADJUSTABLE SHOE SIZES COMFORTABLE ERGONOMIC FOOTBED SOFT HEEL PADS FOR PROPER FOOT PLACEMENT SOFT AND COMFORTABLE FOAM INNER LINER



► NITRO WAKEBOARD BINDINGS BLACK

**PITCH WAKEBOARD 140 & NITRO BINDINGS BLACK SET**

ITEM NUMBER	EAN CODE	HS CODE	FEATURES
278819081	7/8 8718181018746 8/9.5 8718181018753 10/11 8718181018739	95062900	<p><b>BOARD</b></p> <p>FULL WOOD DURABLE CORE. FLEX CONSTRUCTION CONTINUOUS ROCKER HIGH IMPACT BASE MATERIAL</p>
<b>SIZE</b>			
7/8   8/9.5   10/11	<p><b>CARTON INFO BOARD</b></p> <p>QUANTITY PER M. CARTON: 1 M. CARTON WEIGHT (KG): 1 M. CARTON WEIGHT (LBS): 14,3 M. CARTON SIZE (M): 1,5 X 0,51 X 0,1 M. CARTON SIZE (INCH): 59,05 X 20,08 X 3,94</p>	<p><b>CARTON INFO BINDING</b></p> <p>QUANTITY PER M. CARTON: 1 M. CARTON WEIGHT (KG): 2,66 M. CARTON WEIGHT (LBS): 5,85 M. CARTON SIZE (M): 0,37 X 0,32 X 0,19 M. CARTON SIZE (INCH): 14,57 X 12,60 X 7,48</p>	<p><b>BINDINGS</b></p> <p>ADJUSTABLE SHOE SIZES COMFORTABLE ERGONOMIC FOOTBED SOFT HEEL PADS FOR PROPER FOOT PLACEMENT SOFT AND COMFORTABLE FOAM INNER LINER</p>



► NITRO WAKEBOARD BINDINGS BLACK

### PITCH WAKEBOARD 144 & NITRO BINDINGS BLACK SET

ITEM NUMBER	EAN CODE	HS CODE	FEATURES
278819082	7/8 8718181018777 8/9.5 8718181018784 10/11 8718181018760	95062900	<b>BOARD</b> FULL WOOD DURABLE CORE. FLEX CONSTRUCTION CONTINUOUS ROCKER HIGH IMPACT BASE MATERIAL
<b>SIZE</b>			
7/8   8/9.5   10/11	<b>CARTON INFO BOARD</b> QUANTITY PER M. CARTON: 1 M. CARTON WEIGHT (KG): 1 M. CARTON WEIGHT (LBS): 14,3 M. CARTON SIZE (M): 1,5 X 0,51 X 0,1 M. CARTON SIZE (INCH): 59,05 X 20,08 X 3,94	<b>CARTON INFO BINDING</b> QUANTITY PER M. CARTON: 1 M. CARTON WEIGHT (KG): 2,66 M. CARTON WEIGHT (LBS): 5,85 M. CARTON SIZE (M): 0,37 X 0,32 X 0,19 M. CARTON SIZE (INCH): 14,57 X 12,60 X 7,48	<b>BINDINGS</b> ADJUSTABLE SHOE SIZES COMFORTABLE ERGONOMIC FOOTBED SOFT HEEL PADS FOR PROPER FOOT PLACEMENT SOFT AND COMFORTABLE FOAM INNER LINER



► HOST WAKEBOARD BINDINGS PINK

**ARMADA RED WAKEBOARD 137 & HOST BINDINGS PINK SET**

ITEM NUMBER	EAN CODE	HS CODE	FEATURES
278819083	3/6 8718181018791 7/10 8718181018807	95062900	<b>BOARD</b> FULL WOOD DURABLE CORE   FLEX CONSTRUCTION HIGH IMPACT BASE MATERIAL
<b>SIZE</b>			<b>BINDINGS</b> ADJUSTABLE SHOE SIZES COMFORTABLE ERGONOMIC FOOT BED SOFT HEEL PADS FOR PROPER FOOT PLACEMENT SOFT AND COMFORTABLE FOAM INNER LINER STRETCHY FLEX PANELS TO CONTROL YOUR RIDE USER FRIENDLY VELCRO STRAPS FOR A FAST ENTRY
3/6   7/10	<b>CARTON INFO BOARD</b> QUANTITY PER M. CARTON: 1 M. CARTON WEIGHT (KG): 1 M. CARTON WEIGHT (LBS): 14,3 M. CARTON SIZE (M): 1,5 X 0,51 X 0,1 M. CARTON SIZE (INCH): 59,05 X 20,08 X 3,94	<b>CARTON INFO BINDING</b> QUANTITY PER M. CARTON: 1 M. CARTON WEIGHT (KG): 2,76 M. CARTON WEIGHT (LBS): 6,07 M. CARTON SIZE (M): 0,37 X 0,33 X 0,18 M. CARTON SIZE (INCH): 14,57 X 12,99 X 7,09	



► NITRO WAKEBOARD BINDINGS BLACK

**CONCORD WAKEBOARD 137 & NITRO BINDINGS BLACK SET**

ITEM NUMBER	EAN CODE	HS CODE	FEATURES
278819077	7/8 8718181018616 8/9.5 8718181018623 10/11 8718181018609	95062900	<p><b>BOARD</b></p> <ul style="list-style-type: none"> <li>FULL WOOD DURABLE CORE.</li> <li>FLEX CONSTRUCTION</li> <li>HYBRID ROCKER</li> <li>HIGH IMPACT BASE MATERIAL</li> </ul>
<b>SIZE</b>			
7/8   8/9.5   10/11			
	<b>CARTON INFO BOARD</b>	<b>CARTON INFO BINDING</b>	<b>BINDINGS</b>
	<p>QUANTITY PER M. CARTON: 1</p> <p>M. CARTON WEIGHT (KG): 1</p> <p>M. CARTON WEIGHT (LBS): 14,3</p> <p>M. CARTON SIZE (M): 1,5 X 0,51 X 0,1</p> <p>M. CARTON SIZE (INCH): 59,05 X 20,08 X 3,94</p>	<p>QUANTITY PER M. CARTON: 1</p> <p>M. CARTON WEIGHT (KG): 2,66</p> <p>M. CARTON WEIGHT (LBS): 5,85</p> <p>M. CARTON SIZE (M): 0,37 X 0,32 X 0,19</p> <p>M. CARTON SIZE (INCH): 14,57 X 12,60 X 7,48</p>	<ul style="list-style-type: none"> <li>ADJUSTABLE SHOE SIZES</li> <li>COMFORTABLE ERGONOMIC FOOT BED</li> <li>SOFT HEEL PADS FOR PROPER FOOT PLACEMENT</li> <li>SOFT AND COMFORTABLE FOAM INNER LINER</li> </ul>



► NITRO WAKEBOARD BINDINGS BLACK

**CONCORD WAKEBOARD 141 & NITRO BINDINGS BLACK SET**

ITEM NUMBER	EAN CODE	HS CODE	FEATURES
278819078	7/8 8718181018647 8/9.5 8718181018654 10/11 8718181018630	95062900	<p><b>BOARD</b></p> <p>FULL WOOD DURABLE CORE. FLEX CONSTRUCTION HYBRID ROCKER HIGH IMPACT BASE MATERIAL</p>
<b>SIZE</b>			
7/8   8/9.5   10/11	<p><b>CARTON INFO BOARD</b></p> <p>QUANTITY PER M. CARTON: 1 M. CARTON WEIGHT (KG): 1 M. CARTON WEIGHT (LBS): 14,3 M. CARTON SIZE (M): 1,5 X 0,51 X 0,1 M. CARTON SIZE (INCH): 59,05 X 20,08 X 3,94</p>	<p><b>CARTON INFO BINDING</b></p> <p>QUANTITY PER M. CARTON: 1 M. CARTON WEIGHT (KG): 2,66 M. CARTON WEIGHT (LBS): 5,85 M. CARTON SIZE (M): 0,37 X 0,32 X 0,19 M. CARTON SIZE (INCH): 14,57 X 12,60 X 7,48</p>	<p><b>BINDINGS</b></p> <p>ADJUSTABLE SHOE SIZES COMFORTABLE ERGONOMIC FOOT BED SOFT HEEL PADS FOR PROPER FOOT PLACEMENT SOFT AND COMFORTABLE FOAM INNER LINER</p>





► NITRO WAKEBOARD BINDINGS BLACK

### CONCORD WAKEBOARD 145 & NITRO BINDINGS BLACK SET

ITEM NUMBER	EAN CODE	HS CODE	FEATURES
278819079	7/8 8718181018678 8/9.5 8718181018692 10/11 8718181018661	95062900	<b>BOARD</b> FULL WOOD DURABLE CORE. FLEX CONSTRUCTION HYBRID ROCKER HIGH IMPACT BASE MATERIAL
<b>SIZE</b>			
7/8   8/9.5   10/11	<b>CARTON INFO BOARD</b> QUANTITY PER M. CARTON: 1 M. CARTON WEIGHT (KG): 1 M. CARTON WEIGHT (LBS): 14,3 M. CARTON SIZE (M): 1,5 X 0,51 X 0,1 M. CARTON SIZE (INCH): 59,05 X 20,08 X 3,94	<b>CARTON INFO BINDING</b> QUANTITY PER M. CARTON: 1 M. CARTON WEIGHT (KG): 2,66 M. CARTON WEIGHT (LBS): 5,85 M. CARTON SIZE (M): 0,37 X 0,32 X 0,19 M. CARTON SIZE (INCH): 14,57 X 12,60 X 7,48	<b>BINDINGS</b> ADJUSTABLE SHOE SIZES COMFORTABLE ERGONOMIC FOOT BED SOFT HEEL PADS FOR PROPER FOOT PLACEMENT SOFT AND COMFORTABLE FOAM INNER LINER



► NITRO WAKEBOARD BINDINGS BLACK

**RELOAD WAKEBOARD 144 & NITRO BINDINGS BLACK SET**

ITEM NUMBER	EAN CODE	HS CODE	FEATURES
278819075	7/8 8718181018555 8/9.5 8718181018562 10/11 8718181018548	95062900	<p><b>BOARD</b></p> <p>FULL WOOD DURABLE CORE   ABS PROTECTING SIDEWALLS HIGH PRESS FIBERGLASS MOLDED FLEX CONSTRUCTION   3 STAGE ROCKER HIGH IMPACT BASE MATERIAL SHALLOW GROOVED CHANNELS FOR TRACTION AND CONTROL TRIAxIAL FIBER LAYUP</p> <p><b>BINDINGS</b></p> <p>ADJUSTABLE SHOE SIZES COMFORTABLE ERGONOMIC FOOTBED SOFT HEEL PADS FOR PROPER FOOT PLACEMENT SOFT AND COMFORTABLE FOAM INNER LINER</p>
<b>SIZE</b>			
7/8   8/9.5   10/11	<p><b>CARTON INFO BOARD</b></p> <p>QUANTITY PER M. CARTON: 1 M. CARTON WEIGHT (KG): 1 M. CARTON WEIGHT (LBS): 14,3 M. CARTON SIZE (M): 1,5 X 0,51 X 0,1 M. CARTON SIZE (INCH): 59,05 X 20,08 X 3,94</p>	<p><b>CARTON INFO BINDING</b></p> <p>QUANTITY PER M. CARTON: 1 M. CARTON WEIGHT (KG): 2,66 M. CARTON WEIGHT (LBS): 5,85 M. CARTON SIZE (M): 0,37 X 0,32 X 0,19 M. CARTON SIZE (INCH): 14,57 X 12,60 X 7,48</p>	



► NITRO WAKEBOARD BINDINGS BLACK

**RELOAD WAKEBOARD 147 & NITRO BINDINGS BLACK SET**

ITEM NUMBER	EAN CODE	HS CODE	FEATURES
278819076	7/8 8718181018586 8/9.5 8718181018593 10/11 8718181018579	95062900	<p><b>BOARD</b></p> <p>FULL WOOD DURABLE CORE   ABS PROTECTING SIDEWALLS HIGH PRESS FIBERGLASS MOLDED FLEX CONSTRUCTION   3 STAGE ROCKER HIGH IMPACT BASE MATERIAL SHALLOW GROOVED CHANNELS FOR TRACTION AND CONTROL TRIAxIAL FIBER LAYUP</p> <p><b>BINDINGS</b></p> <p>ADJUSTABLE SHOE SIZES COMFORTABLE ERGONOMIC FOOTBED SOFT HEEL PADS FOR PROPER FOOT PLACEMENT SOFT AND COMFORTABLE FOAM INNER LINER</p>
<b>SIZE</b>			
7/8   8/9.5   10/11	<p><b>CARTON INFO BOARD</b></p> <p>QUANTITY PER M. CARTON: 1 M. CARTON WEIGHT (KG): 1 M. CARTON WEIGHT (LBS): 14,3 M. CARTON SIZE (M): 1,5 X 0,51 X 0,1 M. CARTON SIZE (INCH): 59,05 X 20,08 X 3,94</p>	<p><b>CARTON INFO BINDING</b></p> <p>QUANTITY PER M. CARTON: 1 M. CARTON WEIGHT (KG): 2,66 M. CARTON WEIGHT (LBS): 5,85 M. CARTON SIZE (M): 0,37 X 0,32 X 0,19 M. CARTON SIZE (INCH): 14,57 X 12,60 X 7,48</p>	



► NITRO WAKEBOARD BINDINGS COOL GREY

**CONFLICT WAKEBOARD 134 & NITRO BINDINGS COOL GREY SET**

ITEM NUMBER	EAN CODE	HS CODE	FEATURES
278819071	7/8 8718181018432 8/9.5 8718181018449	95062900	<p><b>BOARD</b></p> <p>LIGHT WEIGHT WOOD FOAM CORE. FLEX CONSTRUCTION 3-STAGE ROCKER HIGH IMPACT BASE MATERIAL</p>
<b>SIZE</b>			
7/8   8/9.5	<p><b>CARTON INFO BOARD</b></p> <p>QUANTITY PER M. CARTON: 1 M. CARTON WEIGHT (KG): 1 M. CARTON WEIGHT (LBS): 14,3 M. CARTON SIZE (M): 1,5 X 0,51 X 0,1 M. CARTON SIZE (INCH): 59,05 X 20,08 X 3,94</p>	<p><b>CARTON INFO BINDING</b></p> <p>QUANTITY PER M. CARTON: 1 M. CARTON WEIGHT (KG): 2,66 M. CARTON WEIGHT (LBS): 5,85 M. CARTON SIZE (M): 0,37 X 0,32 X 0,19 M. CARTON SIZE (INCH): 14,57 X 12,60 X 7,48</p>	<p><b>BINDINGS</b></p> <p>ADJUSTABLE SHOE SIZES COMFORTABLE ERGONOMIC FOOTBED SOFT HEEL PADS FOR PROPER FOOT PLACEMENT SOFT AND COMFORTABLE FOAM INNER LINER</p>



► NITRO WAKEBOARD BINDINGS COOL GREY

**CONFLICT WAKEBOARD 138 & NITRO BINDINGS COOL GREY SET**

ITEM NUMBER	EAN CODE	HS CODE	FEATURES
278819072	7/8 8718181018463 8/9.5 8718181018470 10/11 8718181018456	95062900	<b>BOARD</b> LIGHT WEIGHT WOOD FOAM CORE. FLEX CONSTRUCTION 3-STAGE ROCKER HIGH IMPACT BASE MATERIAL
<b>SIZE</b>			<b>BINDINGS</b> ADJUSTABLE SHOE SIZES COMFORTABLE ERGONOMIC FOOTBED SOFT HEEL PADS FOR PROPER FOOT PLACEMENT SOFT AND COMFORTABLE FOAM INNER LINER
7/8   8/9.5   10/11	<b>CARTON INFO BOARD</b> QUANTITY PER M. CARTON: 1 M. CARTON WEIGHT (KG): 1 M. CARTON WEIGHT (LBS): 14,3 M. CARTON SIZE (M): 1,5 X 0,51 X 0,1 M. CARTON SIZE (INCH): 59,05 X 20,08 X 3,94	<b>CARTON INFO BINDING</b> QUANTITY PER M. CARTON: 1 M. CARTON WEIGHT (KG): 2,66 M. CARTON WEIGHT (LBS): 5,85 M. CARTON SIZE (M): 0,37 X 0,32 X 0,19 M. CARTON SIZE (INCH): 14,57 X 12,60 X 7,48	



► NITRO WAKEBOARD BINDINGS COOL GREY

**CONFLICT WAKEBOARD 142 & NITRO BINDINGS COOL GREY SET**

ITEM NUMBER	EAN CODE	HS CODE	FEATURES
278819073	7/8 8718181018494 8/9.5 8718181018500 10/11 8718181018487	95062900	<p><b>BOARD</b></p> <p>LIGHT WEIGHT WOOD FOAM CORE. FLEX CONSTRUCTION 3-STAGE ROCKER HIGH IMPACT BASE MATERIAL</p>
<b>SIZE</b>			
7/8   8/9.5   10/11	<p><b>CARTON INFO BOARD</b></p> <p>QUANTITY PER M. CARTON: 1 M. CARTON WEIGHT (KG): 1 M. CARTON WEIGHT (LBS): 14,3 M. CARTON SIZE (M): 1,5 X 0,51 X 0,1 M. CARTON SIZE (INCH): 59,05 X 20,08 X 3,94</p>	<p><b>CARTON INFO BINDING</b></p> <p>QUANTITY PER M. CARTON: 1 M. CARTON WEIGHT (KG): 2,66 M. CARTON WEIGHT (LBS): 5,85 M. CARTON SIZE (M): 0,37 X 0,32 X 0,19 M. CARTON SIZE (INCH): 14,57 X 12,60 X 7,48</p>	<p><b>BINDINGS</b></p> <p>ADJUSTABLE SHOE SIZES COMFORTABLE ERGONOMIC FOOTBED SOFT HEEL PADS FOR PROPER FOOT PLACEMENT SOFT AND COMFORTABLE FOAM INNER LINER</p>



► NITRO WAKEBOARD BINDINGS COOL GREY

**CONFLICT WAKEBOARD 145 & NITRO BINDINGS COOL GREY SET**

ITEM NUMBER	EAN CODE	HS CODE	FEATURES
278819074	7/8 8718181018524 8/9.5 8718181018531 10/11 8718181018517	95062900	<b>BOARD</b> LIGHT WEIGHT WOOD FOAM CORE. FLEX CONSTRUCTION 3-STAGE ROCKER HIGH IMPACT BASE MATERIAL
<b>SIZE</b>			<b>BINDINGS</b> ADJUSTABLE SHOE SIZES COMFORTABLE ERGONOMIC FOOTBED SOFT HEEL PADS FOR PROPER FOOT PLACEMENT SOFT AND COMFORTABLE FOAM INNER LINER
7/8   8/9.5   10/11	<b>CARTON INFO BOARD</b> QUANTITY PER M. CARTON: 1 M. CARTON WEIGHT (KG): 1 M. CARTON WEIGHT (LBS): 14,3 M. CARTON SIZE (M): 1,5 X 0,51 X 0,1 M. CARTON SIZE (INCH): 59,05 X 20,08 X 3,94	<b>CARTON INFO BINDING</b> QUANTITY PER M. CARTON: 1 M. CARTON WEIGHT (KG): 2,66 M. CARTON WEIGHT (LBS): 5,85 M. CARTON SIZE (M): 0,37 X 0,32 X 0,19 M. CARTON SIZE (INCH): 14,57 X 12,60 X 7,48	

**MIX  
AND  
MATCH**







► SNEAKERS



► BINDING



► SKIN

**PITCH WAKEBOARD 136 & DRIFT BINDINGS SET**

**ITEM NUMBER**

278819023

**SIZE**

6 | 7 | 8 | 9 | 10 | 11

**EAN CODE**

6 8718181017039  
 7 8718181017046  
 8 8718181017053  
 9 8718181017060  
 10 8718181017015  
 11 8718181017022

**HS CODE**

95062900

**FEATURES**

**BOARD:**  
 FULL WOOD DURABLE CORE | FLEX CONSTRUCTION | CONTINUOUS ROCKER | HIGH IMPACT BASE MATERIAL

**SKIN:**  
 FLEXIBLE TPU TO CREATE THE PERFECT WRAPPED FIT | COMPRESSED EVA FOAM OPTIMIZE THE INSIDE GRIP

**BINDING:**  
 STIFF NYLON FRAME WITH FIBERGLASS REINFORCED | CENTERED MOUNTING RESULTS IN DIRECT CONTROL | TAPERED FOOT BED TO OPTIMIZE THE TOE CONTROL

**SNEAKER:**  
 EXTRA WATER DRAINS | QUICK-DRYING MATERIALS | STIFF CONSTRUCTION

**CARTON INFO BOARD**

QUANTITY PER M. CARTON: 1  
 M. CARTON WEIGHT (KG): 6,5  
 M. CARTON WEIGHT (LBS): 14,3  
 M. CARTON SIZE (M): 1,5 X 0,51 X 0,1  
 M. CARTON SIZE (INCH): 59,05 X 20,08 X 3,94

**CARTON INFO SNEAKER**

QUANTITY PER M. CARTON: 1  
 M. CARTON WEIGHT (KG): 2,3  
 M. CARTON WEIGHT (LBS): 4,6  
 M. CARTON SIZE (M): 0,38 X 0,35 X 0,13  
 M. CARTON SIZE (INCH): 14,96 X 13,78 X 5,12

**CARTON INFO BINDING**

QUANTITY PER M. CARTON: 1  
 M. CARTON WEIGHT (KG): 1,71  
 M. CARTON WEIGHT (LBS): 3,76  
 M. CARTON SIZE (M): 0,19 X 0,34 X 0,17  
 M. CARTON SIZE (INCH): 7,48 X 13,39 X 6,69

**CARTON INFO SKIN**

QUANTITY PER M. CARTON: 1  
 M. CARTON WEIGHT (KG): 0,59  
 M. CARTON WEIGHT (LBS): 1,3  
 M. CARTON SIZE (M): 0,16 X 0,29 X 0,12  
 M. CARTON SIZE (INCH): 6,3 X 11,42 X 4,72



► SNEAKERS



► BINDING



► SKIN

**PITCH WAKEBOARD 140 & DRIFT BINDINGS SET**

**ITEM NUMBER**

278819024

**SIZE**

6 | 7 | 8 | 9 | 10 | 11

**EAN CODE**

6 8718181017091  
 7 8718181017107  
 8 8718181017114  
 9 8718181017121  
 10 8718181017077  
 11 8718181017084

**HS CODE**

95062900

**FEATURES**

**BOARD:**  
 FULL WOOD DURABLE CORE | FLEX CONSTRUCTION | CONTINUOUS ROCKER HIGH IMPACT BASE MATERIAL

**SKIN:**  
 FLEXIBLE TPU TO CREATE THE PERFECT WRAPPED FIT | COMPRESSED EVA FOAM OPTIMIZE THE INSIDE GRIP

**BINDING:**  
 STIFF NYLON FRAME WITH FIBERGLASS REINFORCED | CENTERED MOUNTING RESULTS IN DIRECT CONTROL | TAPERED FOOT BED TO OPTIMIZE THE TOE CONTROL

**SNEAKER:**  
 EXTRA WATER DRAINS | QUICK-DRYING MATERIALS | STIFF CONSTRUCTION

**CARTON INFO BOARD**

QUANTITY PER M. CARTON: 1  
 M. CARTON WEIGHT (KG): 6,5  
 M. CARTON WEIGHT (LBS): 14,3  
 M. CARTON SIZE (M): 1,5 X 0,51 X 0,1  
 M. CARTON SIZE (INCH): 59,05 X 20,08 X 3,94

**CARTON INFO SNEAKER**

QUANTITY PER M. CARTON: 1  
 M. CARTON WEIGHT (KG): 2,3  
 M. CARTON WEIGHT (LBS): 4,6  
 M. CARTON SIZE (M): 0,38 X 0,35 X 0,13  
 M. CARTON SIZE (INCH): 14,96 X 13,78 X 5,12

**CARTON INFO BINDING**

QUANTITY PER M. CARTON: 1  
 M. CARTON WEIGHT (KG): 1,71  
 M. CARTON WEIGHT (LBS): 3,76  
 M. CARTON SIZE (M): 0,19 X 0,34 X 0,17  
 M. CARTON SIZE (INCH): 7,48 X 13,39 X 6,69

**CARTON INFO SKIN**

QUANTITY PER M. CARTON: 1  
 M. CARTON WEIGHT (KG): 0,59  
 M. CARTON WEIGHT (LBS): 1,3  
 M. CARTON SIZE (M): 0,16 X 0,29 X 0,12  
 M. CARTON SIZE (INCH): 6,3 X 11,42 X 4,72



► SNEAKERS



► BINDING



► SKIN

**PITCH WAKEBOARD 144 & DRIFT BINDINGS SET**

**ITEM NUMBER**

278819025

**SIZE**

6 | 7 | 8 | 9 | 10 | 11

**EAN CODE**

6 8718181017152  
 7 8718181017169  
 8 8718181017176  
 9 8718181017183  
 10 8718181017138  
 11 8718181017145

**HS CODE**

95062900

**FEATURES**

**BOARD:**  
 FULL WOOD DURABLE CORE | FLEX CONSTRUCTION | CONTINUOUS ROCKER | HIGH IMPACT BASE MATERIAL

**SKIN:**  
 FLEXIBLE TPU TO CREATE THE PERFECT WRAPPED FIT | COMPRESSED EVA FOAM OPTIMIZE THE INSIDE GRIP

**BINDING:**  
 STIFF NYLON FRAME WITH FIBERGLASS REINFORCED | CENTERED MOUNTING RESULTS IN DIRECT CONTROL | TAPERED FOOT BED TO OPTIMIZE THE TOE CONTROL

**SNEAKER:**  
 EXTRA WATER DRAINS | QUICK-DRYING MATERIALS | STIFF CONSTRUCTION

**CARTON INFO BOARD**

QUANTITY PER M. CARTON: 1  
 M. CARTON WEIGHT (KG): 6,5  
 M. CARTON WEIGHT (LBS): 14,3  
 M. CARTON SIZE (M): 1,5 X 0,51 X 0,1  
 M. CARTON SIZE (INCH): 59,05 X 20,08 X 3,94

**CARTON INFO SNEAKER**

QUANTITY PER M. CARTON: 1  
 M. CARTON WEIGHT (KG): 2,3  
 M. CARTON WEIGHT (LBS): 4,6  
 M. CARTON SIZE (M): 0,38 X 0,35 X 0,13  
 M. CARTON SIZE (INCH): 14,96 X 13,78 X 5,12

**CARTON INFO BINDING**

QUANTITY PER M. CARTON: 1  
 M. CARTON WEIGHT (KG): 1,71  
 M. CARTON WEIGHT (LBS): 3,76  
 M. CARTON SIZE (M): 0,19 X 0,34 X 0,17  
 M. CARTON SIZE (INCH): 7,48 X 13,39 X 6,69

**CARTON INFO SKIN**

QUANTITY PER M. CARTON: 1  
 M. CARTON WEIGHT (KG): 0,59  
 M. CARTON WEIGHT (LBS): 1,3  
 M. CARTON SIZE (M): 0,16 X 0,29 X 0,12  
 M. CARTON SIZE (INCH): 6,3 X 11,42 X 4,72



► SNEAKERS



► BINDING



► SKIN

**ARMADA CORAL RED WAKEBOARD 137 & DRIFT BINDINGS SET**

**ITEM NUMBER**

278819026

**EAN CODE**

6 8718181017190  
7 8718181017206  
8 8718181017213

**FEATURES**

**BOARD:**  
FULL WOOD DURABLE CORE | FLEX CONSTRUCTION | HIGH IMPACT BASE MATERIAL

**BINDING:**  
STIFF NYLON FRAME WITH FIBERGLASS REINFORCED | CENTERED MOUNTING RESULTS IN DIRECT CONTROL | TAPERED FOOT BED TO OPTIMIZE THE TOE CONTROL

**SIZE**

6 | 7 | 8

**SKIN:**  
FLEXIBLE TPU TO CREATE THE PERFECT WRAPPED FIT | COMPRESSED EVA FOAM OPTIMIZE THE INSIDE GRIP

**SNEAKER:**  
EXTRA WATER DRAINS | QUICK-DRYING MATERIALS | SOFT CONSTRUCTION

**HS CODE**

95062900

**CARTON INFO BOARD**

QUANTITY PER M. CARTON: 1  
M. CARTON WEIGHT (KG): 6,5  
M. CARTON WEIGHT (LBS): 14,3  
M. CARTON SIZE (M): 1,5 X 0,51 X 0,1  
M. CARTON SIZE (INCH): 59,05 X 20,08 X 3,94

**CARTON INFO SNEAKER**

QUANTITY PER M. CARTON: 1  
M. CARTON WEIGHT (KG): 2,3  
M. CARTON WEIGHT (LBS): 4,6  
M. CARTON SIZE (M): 0,38 X 0,35 X 0,13  
M. CARTON SIZE (INCH): 14,96 X 13,78 X 5,12

**CARTON INFO BINDING**

QUANTITY PER M. CARTON: 1  
M. CARTON WEIGHT (KG): 1,71  
M. CARTON WEIGHT (LBS): 3,76  
M. CARTON SIZE (M): 0,19 X 0,34 X 0,17  
M. CARTON SIZE (INCH): 7,48 X 13,39 X 6,69

**CARTON INFO SKIN**

QUANTITY PER M. CARTON: 1  
M. CARTON WEIGHT (KG): 0,59  
M. CARTON WEIGHT (LBS): 1,3  
M. CARTON SIZE (M): 0,16 X 0,29 X 0,12  
M. CARTON SIZE (INCH): 6,3 X 11,42 X 4,72



► SNEAKERS



► BINDING



► SKIN

**CONCORD WAKEBOARD 137 & DRIFT BINDINGS SET**

**ITEM NUMBER**

278819020

**SIZE**

6 | 7 | 8 | 9 | 10 | 11

**EAN CODE**

6 8718181016858  
 7 8718181016865  
 8 8718181016872  
 9 8718181016889  
 10 8718181016834  
 11 8718181016841

**HS CODE**

95062900

**FEATURES**

**BOARD:**  
 FULL WOOD DURABLE CORE | FLEX CONSTRUCTION | HYBRID ROCKER | HIGH IMPACT BASE MATERIAL

**SKIN:**  
 FLEXIBLE TPU TO CREATE THE PERFECT WRAPPED FIT | COMPRESSED EVA FOAM OPTIMIZE THE INSIDE GRIP

**BINDING:**  
 STIFF NYLON FRAME WITH FIBERGLASS REINFORCED | CENTERED MOUNTING RESULTS IN DIRECT CONTROL | TAPERED FOOT BED TO OPTIMIZE THE TOE CONTROL

**SNEAKER:**  
 EXTRA WATER DRAINS | QUICK-DRYING MATERIALS | STIFF CONSTRUCTION

**CARTON INFO BOARD**

QUANTITY PER M. CARTON: 1  
 M. CARTON WEIGHT (KG): 6,5  
 M. CARTON WEIGHT (LBS): 14,3  
 M. CARTON SIZE (M): 1,5 X 0,51 X 0,1  
 M. CARTON SIZE (INCH): 59,05 X 20,08 X 3,94

**CARTON INFO SNEAKER**

QUANTITY PER M. CARTON: 1  
 M. CARTON WEIGHT (KG): 2,3  
 M. CARTON WEIGHT (LBS): 4,6  
 M. CARTON SIZE (M): 0,38 X 0,35 X 0,13  
 M. CARTON SIZE (INCH): 14,96 X 13,78 X 5,12

**CARTON INFO BINDING**

QUANTITY PER M. CARTON: 1  
 M. CARTON WEIGHT (KG): 1,71  
 M. CARTON WEIGHT (LBS): 3,76  
 M. CARTON SIZE (M): 0,19 X 0,34 X 0,17  
 M. CARTON SIZE (INCH): 7,48 X 13,39 X 6,69

**CARTON INFO SKIN**

QUANTITY PER M. CARTON: 1  
 M. CARTON WEIGHT (KG): 0,59  
 M. CARTON WEIGHT (LBS): 1,3  
 M. CARTON SIZE (M): 0,16 X 0,29 X 0,12  
 M. CARTON SIZE (INCH): 6,3 X 11,42 X 4,72



► SNEAKERS



► BINDING



► SKIN

**CONCORD WAKEBOARD 141 & DRIFT BINDINGS SET**

**ITEM NUMBER**

278819021

**SIZE**

6 | 7 | 8 | 9 | 10 | 11

**EAN CODE**

6 8718181016919  
 7 8718181016926  
 8 8718181016933  
 9 8718181016940  
 10 8718181016896  
 11 8718181016902

**HS CODE**

95062900

**FEATURES**

**BOARD:**  
 FULL WOOD DURABLE CORE | FLEX CONSTRUCTION | HYBRID ROCKER | HIGH IMPACT BASE MATERIAL

**SKIN:**  
 FLEXIBLE TPU TO CREATE THE PERFECT WRAPPED FIT | COMPRESSED EVA FOAM OPTIMIZE THE INSIDE GRIP

**BINDING:**  
 STIFF NYLON FRAME WITH FIBERGLASS REINFORCED | CENTERED MOUNTING RESULTS IN DIRECT CONTROL | TAPERED FOOT BED TO OPTIMIZE THE TOE CONTROL

**SNEAKER:**  
 EXTRA WATER DRAINS | QUICK-DRYING MATERIALS | STIFF CONSTRUCTION

**CARTON INFO BOARD**

QUANTITY PER M. CARTON: 1  
 M. CARTON WEIGHT (KG): 6,5  
 M. CARTON WEIGHT (LBS): 14,3  
 M. CARTON SIZE (M): 1,5 X 0,51 X 0,1  
 M. CARTON SIZE (INCH): 59,05 X 20,08 X 3,94

**CARTON INFO SNEAKER**

QUANTITY PER M. CARTON: 1  
 M. CARTON WEIGHT (KG): 2,3  
 M. CARTON WEIGHT (LBS): 4,6  
 M. CARTON SIZE (M): 0,38 X 0,35 X 0,13  
 M. CARTON SIZE (INCH): 14,96 X 13,78 X 5,12

**CARTON INFO BINDING**

QUANTITY PER M. CARTON: 1  
 M. CARTON WEIGHT (KG): 1,71  
 M. CARTON WEIGHT (LBS): 3,76  
 M. CARTON SIZE (M): 0,19 X 0,34 X 0,17  
 M. CARTON SIZE (INCH): 7,48 X 13,39 X 6,69

**CARTON INFO SKIN**

QUANTITY PER M. CARTON: 1  
 M. CARTON WEIGHT (KG): 0,59  
 M. CARTON WEIGHT (LBS): 1,3  
 M. CARTON SIZE (M): 0,16 X 0,29 X 0,12  
 M. CARTON SIZE (INCH): 6,3 X 11,42 X 4,72



► SNEAKERS



► BINDING



► SKIN

**CONCORD WAKEBOARD 145 & DRIFT BINDINGS SET**

**ITEM NUMBER**

278819022

**SIZE**

6 | 7 | 8 | 9 | 10 | 11

**EAN CODE**

6 8718181016971  
 7 8718181016988  
 8 8718181016995  
 9 8718181017008  
 10 8718181016957  
 11 8718181016964

**HS CODE**

95062900

**FEATURES**

**BOARD:**  
 FULL WOOD DURABLE CORE | FLEX CONSTRUCTION | HYBRID ROCKER | HIGH IMPACT BASE MATERIAL

**SKIN:**  
 FLEXIBLE TPU TO CREATE THE PERFECT WRAPPED FIT | COMPRESSED EVA FOAM OPTIMIZE THE INSIDE GRIP

**BINDING:**  
 STIFF NYLON FRAME WITH FIBERGLASS REINFORCED | CENTERED MOUNTING RESULTS IN DIRECT CONTROL | TAPERED FOOT BED TO OPTIMIZE THE TOE CONTROL

**SNEAKER:**  
 EXTRA WATER DRAINS | QUICK-DRYING MATERIALS | STIFF CONSTRUCTION

**CARTON INFO BOARD**

QUANTITY PER M. CARTON: 1  
 M. CARTON WEIGHT (KG): 6,5  
 M. CARTON WEIGHT (LBS): 14,3  
 M. CARTON SIZE (M): 1,5 X 0,51 X 0,1  
 M. CARTON SIZE (INCH): 59,05 X 20,08 X 3,94

**CARTON INFO SNEAKER**

QUANTITY PER M. CARTON: 1  
 M. CARTON WEIGHT (KG): 2,3  
 M. CARTON WEIGHT (LBS): 4,6  
 M. CARTON SIZE (M): 0,38 X 0,35 X 0,13  
 M. CARTON SIZE (INCH): 14,96 X 13,78 X 5,12

**CARTON INFO BINDING**

QUANTITY PER M. CARTON: 1  
 M. CARTON WEIGHT (KG): 1,71  
 M. CARTON WEIGHT (LBS): 3,76  
 M. CARTON SIZE (M): 0,19 X 0,34 X 0,17  
 M. CARTON SIZE (INCH): 7,48 X 13,39 X 6,69

**CARTON INFO SKIN**

QUANTITY PER M. CARTON: 1  
 M. CARTON WEIGHT (KG): 0,59  
 M. CARTON WEIGHT (LBS): 1,3  
 M. CARTON SIZE (M): 0,16 X 0,29 X 0,12  
 M. CARTON SIZE (INCH): 6,3 X 11,42 X 4,72



► SNEAKERS



► BINDING



► SKIN

**RELOAD WAKEBOARD 144 & DRIFT BINDINGS SET**

**ITEM NUMBER**

278819018

**EAN CODE**

6 8718181016735  
 7 8718181016742  
 8 8718181016759  
 9 8718181016766  
 10 8718181016711  
 11 8718181016728

**FEATURES**

**BOARD:**  
 FULL WOOD DURABLE CORE | ABS PROTECTING SIDEWALLS | HIGH PRESS FIBERGLASS MOLDED | FLEX CONSTRUCTION | 3 STAGE ROCKER | HIGH IMPACT BASE MATERIAL

**BINDING:**  
 STIFF NYLON FRAME WITH FIBERGLASS REINFORCED | CENTERED MOUNTING RESULTS IN DIRECT CONTROL | TAPERED FOOT BED TO OPTIMIZE THE TOE CONTROL

**SIZE**

6 | 7 | 8 | 9 | 10 | 11

**HS CODE**

95062900

**SKIN:**  
 FLEXIBLE TPU TO CREATE THE PERFECT WRAPPED FIT | COMPRESSED EVA FOAM OPTIMIZE THE INSIDE GRIP

**SNEAKER:**  
 EXTRA WATER DRAINS | QUICK-DRYING MATERIALS | STIFF CONSTRUCTION

**CARTON INFO BOARD**

QUANTITY PER M. CARTON: 1  
 M. CARTON WEIGHT (KG): 6,5  
 M. CARTON WEIGHT (LBS): 14,3  
 M. CARTON SIZE (M): 1,5 X 0,51 X 0,1  
 M. CARTON SIZE (INCH): 59,05 X 20,08 X 3,94

**CARTON INFO SNEAKER**

QUANTITY PER M. CARTON: 1  
 M. CARTON WEIGHT (KG): 2,3  
 M. CARTON WEIGHT (LBS): 4,6  
 M. CARTON SIZE (M): 0,38 X 0,35 X 0,13  
 M. CARTON SIZE (INCH): 14,96 X 13,78 X 5,12

**CARTON INFO BINDING**

QUANTITY PER M. CARTON: 1  
 M. CARTON WEIGHT (KG): 1,71  
 M. CARTON WEIGHT (LBS): 3,76  
 M. CARTON SIZE (M): 0,19 X 0,34 X 0,17  
 M. CARTON SIZE (INCH): 7,48 X 13,39 X 6,69

**CARTON INFO SKIN**

QUANTITY PER M. CARTON: 1  
 M. CARTON WEIGHT (KG): 0,59  
 M. CARTON WEIGHT (LBS): 1,3  
 M. CARTON SIZE (M): 0,16 X 0,29 X 0,12  
 M. CARTON SIZE (INCH): 6,3 X 11,42 X 4,72





► SNEAKERS



► BINDING



► SKIN

**RELOAD WAKEBOARD 147 & DRIFT BINDINGS SET**

**ITEM NUMBER**

278819019

**EAN CODE**

6 8718181016797  
 7 8718181016803  
 8 8718181016810  
 9 8718181016827  
 10 8718181016773  
 11 8718181016780

**FEATURES**

**BOARD:**  
 FULL WOOD DURABLE CORE | ABS PROTECTING SIDEWALLS | HIGH PRESS FIBERGLASS MOLDED | FLEX CONSTRUCTION | 3 STAGE ROCKER | HIGH IMPACT BASE MATERIAL

**SKIN:**  
 FLEXIBLE TPU TO CREATE THE PERFECT WRAPPED FIT | COMPRESSED EVA FOAM OPTIMIZE THE INSIDE GRIP

**BINDING:**  
 STIFF NYLON FRAME WITH FIBERGLASS REINFORCED | CENTERED MOUNTING RESULTS IN DIRECT CONTROL | TAPERED FOOT BED TO OPTIMIZE THE TOE CONTROL

**SIZE**

6 | 7 | 8 | 9 | 10 | 11

**HS CODE**

95062900

**SNEAKER:**  
 EXTRA WATER DRAINS | QUICK-DRYING MATERIALS | STIFF CONSTRUCTION

**CARTON INFO BOARD**

QUANTITY PER M. CARTON: 1  
 M. CARTON WEIGHT (KG): 6,5  
 M. CARTON WEIGHT (LBS): 14,3  
 M. CARTON SIZE (M): 1,5 X 0,51 X 0,1  
 M. CARTON SIZE (INCH): 59,05 X 20,08 X 3,94

**CARTON INFO SNEAKER**

QUANTITY PER M. CARTON: 1  
 M. CARTON WEIGHT (KG): 2,3  
 M. CARTON WEIGHT (LBS): 4,6  
 M. CARTON SIZE (M): 0,38 X 0,35 X 0,13  
 M. CARTON SIZE (INCH): 14,96 X 13,78 X 5,12

**CARTON INFO BINDING**

QUANTITY PER M. CARTON: 1  
 M. CARTON WEIGHT (KG): 1,71  
 M. CARTON WEIGHT (LBS): 3,76  
 M. CARTON SIZE (M): 0,19 X 0,34 X 0,17  
 M. CARTON SIZE (INCH): 7,48 X 13,39 X 6,69

**CARTON INFO SKIN**

QUANTITY PER M. CARTON: 1  
 M. CARTON WEIGHT (KG): 0,59  
 M. CARTON WEIGHT (LBS): 1,3  
 M. CARTON SIZE (M): 0,16 X 0,29 X 0,12  
 M. CARTON SIZE (INCH): 6,3 X 11,42 X 4,72



► SNEAKERS



► BINDING



► SKIN

**CONFLICT WAKEBOARD 127 & DRIFT BINDINGS SET**

ITEM NUMBER	EAN CODE	FEATURES
278819013	6 8718181016469 7 8718181016476 8 8718181016483	<p><b>BOARD:</b> LIGHT WEIGHT WOOD FOAM CORE   FLEX CONSTRUCTION   3-STAGE ROCKER   HIGH IMPACT BASE MATERIAL</p> <p><b>SKIN:</b> FLEXIBLE TPU TO CREATE THE PERFECT WRAPPED FIT   COMPRESSED EVA FOAM OPTIMIZE THE INSIDE GRIP</p> <p><b>BINDING:</b> STIFF NYLON FRAME WITH FIBERGLASS REINFORCED   CENTERED MOUNTING RESULTS IN DIRECT CONTROL   TAPERED FOOT BED TO OPTIMIZE THE TOE CONTROL</p> <p><b>SNEAKER:</b> EXTRA WATER DRAINS   QUICK-DRYING MATERIALS   STIFF CONSTRUCTION</p>
SIZE	HS CODE	
6   7   8	95062900	

CARTON INFO BOARD	CARTON INFO SNEAKER	CARTON INFO BINDING	CARTON INFO SKIN
<p>QUANTITY PER M. CARTON: 1</p> <p>M. CARTON WEIGHT (KG): 6</p> <p>M. CARTON WEIGHT (LBS): 13,2</p> <p>M. CARTON SIZE (M): 1,4 X 0,49 X 0,09</p> <p>M. CARTON SIZE (INCH): 55,12 X 19,29 X 3,54</p>	<p>QUANTITY PER M. CARTON: 1</p> <p>M. CARTON WEIGHT (KG): 2,3</p> <p>M. CARTON WEIGHT (LBS): 4,6</p> <p>M. CARTON SIZE (M): 0,38 X 0,35 X 0,13</p> <p>M. CARTON SIZE (INCH): 14,96 X 13,78 X 5,12</p>	<p>QUANTITY PER M. CARTON: 1</p> <p>M. CARTON WEIGHT (KG): 1,71</p> <p>M. CARTON WEIGHT (LBS): 3,76</p> <p>M. CARTON SIZE (M): 0,19 X 0,34 X 0,17</p> <p>M. CARTON SIZE (INCH): 7,48 X 13,39 X 6,69</p>	<p>QUANTITY PER M. CARTON: 1</p> <p>M. CARTON WEIGHT (KG): 0,59</p> <p>M. CARTON WEIGHT (LBS): 1,3</p> <p>M. CARTON SIZE (M): 0,16 X 0,29 X 0,12</p> <p>M. CARTON SIZE (INCH): 6,3 X 11,42 X 4,72</p>



► SNEAKERS



► BINDING



► SKIN

**CONFLICT WAKEBOARD 134 & DRIFT BINDINGS SET**

**ITEM NUMBER**

278819014

**EAN CODE**

6 8718181016490  
7 8718181016506  
8 8718181016513  
9 8718181016520

**FEATURES**

**BOARD:**  
LIGHT WEIGHT WOOD FOAM CORE | FLEX CONSTRUCTION | 3-STAGE ROCKER | HIGH IMPACT BASE MATERIAL

**BINDING:**  
STIFF NYLON FRAME WITH FIBERGLASS REINFORCED | CENTERED MOUNTING RESULTS IN DIRECT CONTROL | TAPERED FOOT BED TO OPTIMIZE THE TOE CONTROL

**SIZE**

6 | 7 | 8 | 9

**HS CODE**

95062900

**SKIN:**  
FLEXIBLE TPU TO CREATE THE PERFECT WRAPPED FIT | COMPRESSED EVA FOAM OPTIMIZE THE INSIDE GRIP

**SNEAKER:**  
EXTRA WATER DRAINS | QUICK-DRYING MATERIALS | STIFF CONSTRUCTION

**CARTON INFO BOARD**

QUANTITY PER M. CARTON: 1  
M. CARTON WEIGHT (KG): 6,5  
M. CARTON WEIGHT (LBS): 14,3  
M. CARTON SIZE (M): 1,5 X 0,51 X 0,1  
M. CARTON SIZE (INCH): 59,05 X 20,08 X 3,94

**CARTON INFO SNEAKER**

QUANTITY PER M. CARTON: 1  
M. CARTON WEIGHT (KG): 2,3  
M. CARTON WEIGHT (LBS): 4,6  
M. CARTON SIZE (M): 0,38 X 0,35 X 0,13  
M. CARTON SIZE (INCH): 14,96 X 13,78 X 5,12

**CARTON INFO BINDING**

QUANTITY PER M. CARTON: 1  
M. CARTON WEIGHT (KG): 1,71  
M. CARTON WEIGHT (LBS): 3,76  
M. CARTON SIZE (M): 0,19 X 0,34 X 0,17  
M. CARTON SIZE (INCH): 7,48 X 13,39 X 6,69

**CARTON INFO SKIN**

QUANTITY PER M. CARTON: 1  
M. CARTON WEIGHT (KG): 0,59  
M. CARTON WEIGHT (LBS): 1,3  
M. CARTON SIZE (M): 0,16 X 0,29 X 0,12  
M. CARTON SIZE (INCH): 6,3 X 11,42 X 4,72



► SNEAKERS



► BINDING



► SKIN

**CONFLICT WAKEBOARD 138 & DRIFT BINDINGS SET**

**ITEM NUMBER**

278819015

**EAN CODE**

6 8718181016551  
 7 8718181016568  
 8 8718181016575  
 9 8718181016582  
 10 8718181016537  
 11 8718181016544

**FEATURES**

**BOARD:**  
 LIGHT WEIGHT WOOD FOAM CORE | FLEX CONSTRUCTION | 3-STAGE ROCKER | HIGH IMPACT BASE MATERIAL

**BINDING:**  
 STIFF NYLON FRAME WITH FIBERGLASS REINFORCED | CENTERED MOUNTING RESULTS IN DIRECT CONTROL | TAPERED FOOT BED TO OPTIMIZE THE TOE CONTROL

**SIZE**

6 | 7 | 8 | 9 | 10 | 11

**SKIN:**  
 FLEXIBLE TPU TO CREATE THE PERFECT WRAPPED FIT | COMPRESSED EVA FOAM OPTIMIZE THE INSIDE GRIP

**SNEAKER:**  
 EXTRA WATER DRAINS | QUICK-DRYING MATERIALS | STIFF CONSTRUCTION

**HS CODE**

95062900

**CARTON INFO BOARD**

QUANTITY PER M. CARTON: 1  
 M. CARTON WEIGHT (KG): 6,5  
 M. CARTON WEIGHT (LBS): 14,3  
 M. CARTON SIZE (M): 1,5 X 0,51 X 0,1  
 M. CARTON SIZE (INCH): 59,05 X 20,08 X 3,94

**CARTON INFO SNEAKER**

QUANTITY PER M. CARTON: 1  
 M. CARTON WEIGHT (KG): 2,3  
 M. CARTON WEIGHT (LBS): 4,6  
 M. CARTON SIZE (M): 0,38 X 0,35 X 0,13  
 M. CARTON SIZE (INCH): 14,96 X 13,78 X 5,12

**CARTON INFO BINDING**

QUANTITY PER M. CARTON: 1  
 M. CARTON WEIGHT (KG): 1,71  
 M. CARTON WEIGHT (LBS): 3,76  
 M. CARTON SIZE (M): 0,19 X 0,34 X 0,17  
 M. CARTON SIZE (INCH): 7,48 X 13,39 X 6,69

**CARTON INFO SKIN**

QUANTITY PER M. CARTON: 1  
 M. CARTON WEIGHT (KG): 0,59  
 M. CARTON WEIGHT (LBS): 1,3  
 M. CARTON SIZE (M): 0,16 X 0,29 X 0,12  
 M. CARTON SIZE (INCH): 6,3 X 11,42 X 4,72



► SNEAKERS



► BINDING



► SKIN

**CONFLICT WAKEBOARD 142 & DRIFT BINDINGS SET**

**ITEM NUMBER**

278819016

**EAN CODE**

6 8718181016612  
 7 8718181016629  
 8 8718181016636  
 9 8718181016643  
 10 8718181016599  
 11 8718181016605

**FEATURES**

**BOARD:**  
 LIGHT WEIGHT WOOD FOAM CORE | FLEX CONSTRUCTION | 3-STAGE ROCKER | HIGH IMPACT BASE MATERIAL

**BINDING:**  
 STIFF NYLON FRAME WITH FIBERGLASS REINFORCED | CENTERED MOUNTING RESULTS IN DIRECT CONTROL | TAPERED FOOT BED TO OPTIMIZE THE TOE CONTROL

**SIZE**

6 | 7 | 8 | 9 | 10 | 11

**HS CODE**

95062900

**SKIN:**  
 FLEXIBLE TPU TO CREATE THE PERFECT WRAPPED FIT | COMPRESSED EVA FOAM OPTIMIZE THE INSIDE GRIP

**SNEAKER:**  
 EXTRA WATER DRAINS | QUICK-DRYING MATERIALS | STIFF CONSTRUCTION

**CARTON INFO BOARD**

QUANTITY PER M. CARTON: 1  
 M. CARTON WEIGHT (KG): 6,5  
 M. CARTON WEIGHT (LBS): 14,3  
 M. CARTON SIZE (M): 1,5 X 0,51 X 0,1  
 M. CARTON SIZE (INCH): 59,05 X 20,08 X 3,94

**CARTON INFO SNEAKER**

QUANTITY PER M. CARTON: 1  
 M. CARTON WEIGHT (KG): 2,3  
 M. CARTON WEIGHT (LBS): 4,6  
 M. CARTON SIZE (M): 0,38 X 0,35 X 0,13  
 M. CARTON SIZE (INCH): 14,96 X 13,78 X 5,12

**CARTON INFO BINDING**

QUANTITY PER M. CARTON: 1  
 M. CARTON WEIGHT (KG): 1,71  
 M. CARTON WEIGHT (LBS): 3,76  
 M. CARTON SIZE (M): 0,19 X 0,34 X 0,17  
 M. CARTON SIZE (INCH): 7,48 X 13,39 X 6,69

**CARTON INFO SKIN**

QUANTITY PER M. CARTON: 1  
 M. CARTON WEIGHT (KG): 0,59  
 M. CARTON WEIGHT (LBS): 1,3  
 M. CARTON SIZE (M): 0,16 X 0,29 X 0,12  
 M. CARTON SIZE (INCH): 6,3 X 11,42 X 4,72



► SNEAKERS



► BINDING



► SKIN

**CONFLICT WAKEBOARD 145 & DRIFT BINDINGS SET**

**ITEM NUMBER**

278819017

**EAN CODE**

6 8718181016674  
 7 8718181016681  
 8 8718181016698  
 9 8718181016704  
 10 8718181016650  
 11 8718181016667

**FEATURES**

**BOARD:**  
 LIGHT WEIGHT WOOD FOAM CORE | FLEX CONSTRUCTION | 3-STAGE ROCKER | HIGH IMPACT BASE MATERIAL

**BINDING:**  
 STIFF NYLON FRAME WITH FIBERGLASS REINFORCED | CENTERED MOUNTING RESULTS IN DIRECT CONTROL | TAPERED FOOT BED TO OPTIMIZE THE TOE CONTROL

**SIZE**

6 | 7 | 8 | 9 | 10 | 11

**SKIN:**  
 FLEXIBLE TPU TO CREATE THE PERFECT WRAPPED FIT | COMPRESSED EVA FOAM OPTIMIZE THE INSIDE GRIP

**SNEAKER:**  
 EXTRA WATER DRAINS | QUICK-DRYING MATERIALS | STIFF CONSTRUCTION

**HS CODE**

95062900

**CARTON INFO BOARD**

QUANTITY PER M. CARTON: 1  
 M. CARTON WEIGHT (KG): 6,5  
 M. CARTON WEIGHT (LBS): 14,3  
 M. CARTON SIZE (M): 1,5 X 0,51 X 0,1  
 M. CARTON SIZE (INCH): 59,05 X 20,08 X 3,94

**CARTON INFO SNEAKER**

QUANTITY PER M. CARTON: 1  
 M. CARTON WEIGHT (KG): 2,3  
 M. CARTON WEIGHT (LBS): 4,6  
 M. CARTON SIZE (M): 0,38 X 0,35 X 0,13  
 M. CARTON SIZE (INCH): 14,96 X 13,78 X 5,12

**CARTON INFO BINDING**

QUANTITY PER M. CARTON: 1  
 M. CARTON WEIGHT (KG): 1,71  
 M. CARTON WEIGHT (LBS): 3,76  
 M. CARTON SIZE (M): 0,19 X 0,34 X 0,17  
 M. CARTON SIZE (INCH): 7,48 X 13,39 X 6,69

**CARTON INFO SKIN**

QUANTITY PER M. CARTON: 1  
 M. CARTON WEIGHT (KG): 0,59  
 M. CARTON WEIGHT (LBS): 1,3  
 M. CARTON SIZE (M): 0,16 X 0,29 X 0,12  
 M. CARTON SIZE (INCH): 6,3 X 11,42 X 4,72



**PITCH WAKEBOARD SERIES**

ITEM NUMBER	EAN CODE	HS CODE	FEATURES
272519004	136 8718181015288 140 8718181001052 144 8718181015295	95062900	FULL WOOD DURABLE CORE. ABS PROTECTING SIDEWALLS HIGH PRESS FIBERGLASS MOLDED FLEX CONSTRUCTION CONTINUOUS ROCKER HIGH IMPACT BASE MATERIAL SHALLOW GROOVED CHANNELS FOR TRACTION AND CONTROL TRIAXIAL FIBER LAYUP. TIP AND TAIL CHANNELS FOR TRACTION DURING THE RIDE
<b>SIZE</b>		<b>MASTER CARTON INFO</b>	
136   140   144		QUANTITY PER M. CARTON: 1 M. CARTON WEIGHT (KG): 6,71 M. CARTON WEIGHT (LBS): 14,762 M. CARTON SIZE (M): 1,5 X 0,5 X 0,09 M. CARTON SIZE (INCH): 59,06 X 19,69 X 3,35	



**ARMADA WAKEBOARD SERIES**

ITEM NUMBER	EAN CODE	HS CODE	FEATURES
272519001	137 8718181015233	95062900	FULL WOOD DURABLE CORE. ABS PROTECTING SIDEWALLS HIGH PRESS FIBERGLASS MOLDED FLEX CONSTRUCTION HYBRID ROCKER HIGH IMPACT BASE MATERIAL SHALLOW GROOVED CHANNELS FOR TRACTION AND CONTROL TRIAxIAL FIBER LAYUP
<b>SIZE</b>		<b>MASTER CARTON INFO</b>	
137		QUANTITY PER M. CARTON: 1 M. CARTON WEIGHT (KG): 6,25 M. CARTON WEIGHT (LBS): 13,75 M. CARTON SIZE (M): 1,5X0,5X0,09 M. CARTON SIZE (INCH): 59,06X19,69X3,35	





**CONCORD WAKEBOARD SERIES**

ITEM NUMBER	EAN CODE	HS CODE	FEATURES
272519003	137 8718181015271 141 8718181001038 145 8718181001045	95062900	FULL WOOD DURABLE CORE. ABS PROTECTING SIDEWALLS HIGH PRESS FIBERGLASS MOLDED FLEX CONSTRUCTION HYBRID ROCKER HIGH IMPACT BASE MATERIAL SHALLOW GROOVED CHANNELS FOR TRACTION AND CONTROL TRIAIXIAL FIBER LAYUP.
<b>SIZE</b>		<b>MASTER CARTON INFO</b>	
137   141   145		QUANTITY PER M. CARTON: 1 M. CARTON WEIGHT (KG): 6,71 M. CARTON WEIGHT (LBS): 14,762 M. CARTON SIZE (M): 1,5X0,5X0,09 M. CARTON SIZE (INCH): 59,06X19,69X3,35	



**RELOAD WAKEBOARD SERIES**

ITEM NUMBER	EAN CODE	HS CODE	FEATURES
272519009	144 8718181015301 147 8718181015318	95062900	FULL WOOD DURABLE CORE. ABS PROTECTING SIDEWALLS HIGH PRESS FIBERGLASS MOLDED FLEX CONSTRUCTION 3 STAGE ROCKER HIGH IMPACT BASE MATERIAL SHALLOW GROOVED CHANNELS FOR TRACTION AND CONTROL TRIAxIAL FIBER LAYUP.
<b>SIZE</b>		<b>MASTER CARTON INFO</b>	
144   147		QUANTITY PER M. CARTON: 1 M. CARTON WEIGHT (KG): 6,71 M. CARTON WEIGHT (LBS): 14,762 M. CARTON SIZE (M): 1,5X0,5X0,09 M. CARTON SIZE (INCH): 59,06X19,69X3,35	



**CONFLICT WAKEBOARD SERIES**

ITEM NUMBER	EAN CODE	HS CODE	FEATURES
272519002	127 8718181015240	95062900	LIGHT WEIGHT WOOD FOAM CORE. ABS PROTECTING SIDEWALLS HIGH PRESS FIBERGLASS MOLDED FLEX CONSTRUCTION 3-STAGE ROCKER HIGH IMPACT BASE MATERIAL SMOOTH GROOVED CHANNELS FOR TRACTION AND CONTROL TRIAXIAL FIBER LAYUP. WOOD VENEER TOP LAYER FOR DURABILITY.
	134 8718181015257		
	138 8718181015264		
<b>SIZE</b>	142 8718181000994	<b>MASTER CARTON INFO</b>	
	145 8718181001021		
127   134   138   142   145		QUANTITY PER M. CARTON: 1 M. CARTON WEIGHT (KG): 6,16 M. CARTON WEIGHT (LBS): 13,552 M. CARTON SIZE (M): 1,36 X 0,5 X 0,09 M. CARTON SIZE (INCH): 53,54 X 19,69 X 3,35	





**WAKEBOARD REPAIR KIT**

ITEM NUMBER	EAN CODE	HS CODE	FEATURES
420005004	PCS. 7283927710174	35061000	FIBERGLASS REPAIR KIT UV CURE
<b>SIZE</b>	<b>MASTER CARTON INFO</b>		
PCS.	QUANTITY PER M. CARTON: 300 M. CARTON WEIGHT (KG): 33 M. CARTON WEIGHT (LBS): 72,6 M. CARTON SIZE (M): 0,51 X 0,41 X 0,23 M. CARTON SIZE (INCH): 20 X 16 X 9		



**MAZE WAKEBOARD BINDINGS**

ITEM NUMBER	EAN CODE	HS CODE	FEATURES
393119001	STAND 8718181006958	95062900	ADJUSTABLE SHOE SIZES STRETCHY FLEX PANELS TO CONTROL YOUR RIDE SINGLE LACE PERFECT WRAPPED FIT CUSTOM JOBE LACE LOCK TO SECURE YOUR RIDE.
SIZE	MASTER CARTON INFO		
STAND	QUANTITY PER M. CARTON: 8 M. CARTON WEIGHT (KG): 13,6 M. CARTON WEIGHT (LBS): 29,92 M. CARTON SIZE (M): 0,77 X 0,65 X 0,31 M. CARTON SIZE (INCH): 30,31 X 25,99 X 12,2		



### UNIT WAKEBOARD BINDINGS

ITEM NUMBER	EAN CODE	HS CODE	FEATURES
393119101	3/6 8718181007030 7/10 8718181007047 10/12 8718181007023	95062900	ADJUSTABLE SHOE SIZES STRETCHY FLEX PANELS TO CONTROL YOUR RIDE SINGLE LACE PERFECT WRAPPED FIT CUSTOM JOBE LACE LOCK TO SECURE YOUR RIDE.
SIZE	MASTER CARTON INFO		
3/6   7/10   10/12	QUANTITY PER M. CARTON: 6 M. CARTON WEIGHT (KG): 14,04 M. CARTON WEIGHT (LBS): 30,888 M. CARTON SIZE (M): 0,56 X 0,4 X 0,7 M. CARTON SIZE (INCH): 21,85 X 15,75 X 27,56		



**REPUBLIC WAKEBOARD BINDINGS**

ITEM NUMBER	EAN CODE	HS CODE	FEATURES
393119102	3/6 8718181007061 7/10 8718181007078 10/12 8718181007054	95062900	ADJUSTABLE SHOE SIZES COMFORTABLE ERGONOMIC FOOT BED SOFT HEEL PADS FOR PROPER FOOT PLACEMENT SOFT AND COMFORTABLE FOAM INNER LINER STRETCHY FLEX PANELS TO CONTROL YOUR RIDE SINGLE LACE PERFECT WRAPPED FIT CUSTOM JOBE LACE LOCK TO SECURE YOUR RIDE.
<b>SIZE</b>		<b>MASTER CARTON INFO</b>	
3/6   7/10   10/12		QUANTITY PER M. CARTON: 6 M. CARTON WEIGHT (KG): 15,42 M. CARTON WEIGHT (LBS): 33,924 M. CARTON SIZE (M): 0,56 X 0,4 X 0,7 M. CARTON SIZE (INCH): 21,85 X 15,75 X 27,56	





### HOST WAKEBOARD BINDINGS BLUE

ITEM NUMBER	EAN CODE	HS CODE	FEATURES
393119002	3/6 8718181006972 7/10 8718181006989 10/12 8718181006965	95062900	ADJUSTABLE SHOE SIZES COMFORTABLE ERGONOMIC FOOT BED SOFT HEEL PADS FOR PROPER FOOT PLACEMENT SOFT AND COMFORTABLE FOAM INNER LINER STRETCHY FLEX PANELS TO CONTROL YOUR RIDE USER FRIENDLY VELCRO STRAPS FOR A FAST ENTRY
<b>SIZE</b>		<b>MASTER CARTON INFO</b>	
3/6   7/10   10/12		QUANTITY PER M. CARTON: 6 M. CARTON WEIGHT (KG): 16,56 M. CARTON WEIGHT (LBS): 36,432 M. CARTON SIZE (M): 0,56X0,4X0,7 M. CARTON SIZE (INCH): 21,85X15,75X27,56	



**HOST WAKEBOARD BINDINGS PINK**

ITEM NUMBER	EAN CODE	HS CODE	FEATURES
393119003	3/6 8718181007009 7/10 8718181007016 10/12 8718181006996	95062900	ADJUSTABLE SHOE SIZES COMFORTABLE ERGONOMIC FOOT BED SOFT HEEL PADS FOR PROPER FOOT PLACEMENT SOFT AND COMFORTABLE FOAM INNER LINER STRETCHY FLEX PANELS TO CONTROL YOUR RIDE USER FRIENDLY VELCRO STRAPS FOR A FAST ENTRY
<b>SIZE</b>		<b>MASTER CARTON INFO</b>	
3/6   7/10   10/12		QUANTITY PER M. CARTON: 6 M. CARTON WEIGHT (KG): 16,56 M. CARTON WEIGHT (LBS): 36,432 M. CARTON SIZE (M): 0,56 X 0,4 X 0,7 M. CARTON SIZE (INCH): 21,85 X 15,75 X 27,56	



### HOST WAKEBOARD BINDINGS BLACK

ITEM NUMBER	EAN CODE	HS CODE	FEATURES
393118002	3/6 8718181260114 7/10 8718181260121 10/12 8718181260138	95062900	ADJUSTABLE SHOE SIZES COMFORTABLE ERGONOMIC FOOT BED SOFT HEEL PADS FOR PROPER FOOT PLACEMENT SOFT AND COMFORTABLE FOAM INNER LINER STRETCHY FLEX PANELS TO CONTROL YOUR RIDE USER FRIENDLY VELCRO STRAPS FOR A FAST ENTRY
<b>SIZE</b>		<b>MASTER CARTON INFO</b>	
3/6   7/10   10/12		QUANTITY PER M. CARTON: 6 M. CARTON WEIGHT (KG): 16,56 M. CARTON WEIGHT (LBS): 36,432 M. CARTON SIZE (M): 0,56X0,4X0,7 M. CARTON SIZE (INCH): 21,85X15,75X27,56	



**NITRO WAKEBOARD BINDINGS BLACK**

ITEM NUMBER	EAN CODE	HS CODE	FEATURES
393018004	7/8 8718181259996 8/9.5 8718181260008 10/11 8718181260015	95062900	ADJUSTABLE SHOE SIZES COMFORTABLE ERGONOMIC FOOTBED SOFT HEEL PADS FOR PROPER FOOT PLACEMENT SOFT AND COMFORTABLE FOAM INNER LINER STRETCH ' FLEX PANELS TO CONTROL YOUR RIDE DOUBLE LACE CONSTRUCTION PERFECT WRAPPED FIT CUSTOM JOBE LACELOCK TO SECURE YOUR RIDE LACE POCKETS TO PLACE THE LACE HANDLE DURING THE YOUR RIDE.
<b>SIZE</b>		<b>MASTER CARTON INFO</b>	
7/8   8/9.5   10/11		QUANTITY PER M. CARTON: 6 M. CARTON WEIGHT (KG): 18,06 M. CARTON WEIGHT (LBS): 39,732 M. CARTON SIZE (M): 0,56X0,4X0,7 M. CARTON SIZE (INCH): 21,85X15,75X27,56	



**NITRO WAKEBOARD BINDINGS COOL GREY**

ITEM NUMBER	EAN CODE	HS CODE	FEATURES
393019001	S 8718181006941 M 8718181006934 L 8718181006927	95062900	ADJUSTABLE SHOE SIZES COMFORTABLE ERGONOMIC FOOTBED SOFT HEEL PADS FOR PROPER FOOT PLACEMENT SOFT AND COMFORTABLE FOAM INNER LINER STRETCH ' FLEX PANELS TO CONTROL YOUR RIDE DOUBLE LACE CONSTRUCTION PERFECT WRAPPED FIT CUSTOM JOBE LACELOCK TO SECURE YOUR RIDE LACE POCKETS TO PLACE THE LACE HANDLE DURING THE YOUR RIDE
<b>SIZE</b>		<b>MASTER CARTON INFO</b>	
S   M   L		QUANTITY PER M. CARTON: 6 M. CARTON WEIGHT (KG): 18,06 M. CARTON WEIGHT (LBS): 39,732 M. CARTON SIZE (M): 0,56 X 0,4 X 0,7 M. CARTON SIZE (INCH): 21,85 X 15,75 X 27,56	



**DRIFT WAKEBOARD SNEAKERS**

ITEM NUMBER	EAN CODE	HS CODE	FEATURES
396817002	6 8718181228886	64039113	REINFORCED HEEL FOR EXTRA SUPPORT
	7 8718181228893		RUBBER OUTSOLE FOR A MAXIMUM GRIP
	8 8718181228909		EXTRA WATER DRAINS
<b>SIZE</b>	9 8718181228916	<b>MASTER CARTON INFO</b>	QUICK-DRYING MATERIALS
	10 8718181228862		STIFF CONSTRUCTION
6   7   8   9   10   11	11 8718181228879	QUANTITY PER M. CARTON:	SUPPORTIVE INSOLE
		M. CARTON WEIGHT (KG):	5
		M. CARTON WEIGHT (LBS):	12,25
		M. CARTON SIZE (M):	0,33X0,24X0,65
		M. CARTON SIZE (INCH):	12,99 X 9,45 X 25,59



### EVO ADAPTER SET

ITEM NUMBER	EAN CODE	HS CODE	FEATURES
397017005	S/M 8718181247351 L 8718181247344	95062900	REINFORCED NYLON ADAPTER TO ATTACH AN EVO BINDING TO ALL 6-INSERTS SETUPS WAKEBOARDS SIZE S/M FITS ALL M BINDINGS SIZE L FITS SIZE L BINDINGS.
SIZE		MASTER CARTON INFO	
S/M   L		QUANTITY PER M. CARTON: 20 M. CARTON WEIGHT (KG): 18,7 M. CARTON WEIGHT (LBS): 41,14 M. CARTON SIZE (M): 0,42X0,29X0,34 M. CARTON SIZE (INCH): 16,54X11,42X13,19	<b>ADAPTER CONTENTS:</b> 8 SCREWS TO SECURE THE EVO BINDING WITH THE ADAPTER. 4 SCREWS WITH WASHERS. TO SECURE THE ADAPTER WITH YOUR BOARD.



**DRIFT WAKEBOARD BINDINGS**

ITEM NUMBER	EAN CODE	HS CODE	FEATURES
397017001	M 8718181229555 L 8718181229548	95062900	STIFF NYLON FRAME WITH FIBERGLASS REINFORCED. CENTERED MOUNTING RESULTS IN DIRECT CONTROL. MINIMIZED HEEL LIFT. SOFT AIRBAG TO ABSORB LANDINGS. TAPERED FOOT BED TO OPTIMIZE THE TOE CONTROL
<b>SIZE</b>		<b>MASTER CARTON INFO</b>	
M   L		QUANTITY PER M. CARTON: 9 M. CARTON WEIGHT (KG): 15,39 M. CARTON WEIGHT (LBS): 33,858 M. CARTON SIZE (M): 0,55 X 0,35 X 0,52 M. CARTON SIZE (INCH): 21,5 X 13,94 X 20,63	





### DRIFT WAKEBOARD BINDING SKIN

ITEM NUMBER	EAN CODE	HS CODE	FEATURES
396917001	S 8718181238724 M 8718181238717 L 8718181238700	95062900	FLEXIBLE TPU TO CREATE THE PERFECT WRAPPED FIT. COMPRESSED EVA FOAM OPTIMIZE THE INSIDE GRIP DURABLE AND EASY TO REPLACE NYLON LACES CUSTOM JOBE LACE LOCK TO SECURE.
<b>SIZE</b>		<b>MASTER CARTON INFO</b>	
S   M   L		QUANTITY PER M. CARTON: 20 M. CARTON WEIGHT (KG): 11,8 M. CARTON WEIGHT (LBS): 25,96 M. CARTON SIZE (M): 0,61X0,29X0,59 M. CARTON SIZE (INCH): 24,09X11,3X23,23	

**WAKEBOARD FIN**

<b>ITEM NUMBER</b>	<b>EAN CODE</b>	<b>HS CODE</b>	<b>FEATURES</b>
279918001	PCS. 8718181255929	95062900	
<b>SIZE</b>		<b>MASTER CARTON INFO</b>	
PCS.		QUANTITY PER M. CARTON: 1	
		M. CARTON WEIGHT (KG): 0,11	
		M. CARTON WEIGHT (LBS): 0,24	
		M. CARTON SIZE (M): 0,20 X 0,05 X 0,01	
		M. CARTON SIZE (INCH): 7,87 X 1,97 X 0,39	





**PRIME WAKE COMBO RED**

ITEM NUMBER	EAN CODE	HS CODE	FEATURES
211317014	PCS. 8718181209373	95062900	EVA FOAM GRIP PENCIL FLOATS 15 INCH/38.1 CM MAINLINE HANDLE
<b>SIZE</b>	<b>MASTER CARTON INFO</b>		
PCS.	QUANTITY PER M. CARTON: 12 M. CARTON WEIGHT (KG): 8,52 M. CARTON WEIGHT (LBS): 18,744 M. CARTON SIZE (M): 0,5X0,39X0,34 M. CARTON SIZE (INCH): 19,69 X 15,35 X 13,39		
55 FT./16.76 M MAINLINE			1 SECTIONED ROPE WAKEBOARD HANDLE AND ROPE



**PRIME WAKE COMBO BLUE**

ITEM NUMBER	EAN CODE	HS CODE	FEATURES
211317012	PCS. 8718181209298	95062900	EVA FOAM GRIP PENCIL FLOATS 15 INCH/38.1 CM MAINLINE HANDLE
<b>SIZE</b>	<b>MASTER CARTON INFO</b>		
PCS.	QUANTITY PER M. CARTON: 12 M. CARTON WEIGHT (KG): 7,92 M. CARTON WEIGHT (LBS): 17,424 M. CARTON SIZE (M): 0,5X0,4X0,34 M. CARTON SIZE (INCH): 19,69 X 15,55 X 13,39		



**PRIME WAKE COMBO YELLOW**

ITEM NUMBER	EAN CODE	HS CODE	FEATURES
211317015	PCS. 8718181236690	95062900	EVA FOAM GRIP PENCIL FLOATS 15 INCH/38.1 CM MAINLINE HANDLE 27.5 DIAMETER GRIP 55 FT./16.76 M MAINLINE 1 SECTIONED ROPE WAKEBOARD HANDLE AND ROPE
<b>SIZE</b>		<b>MASTER CARTON INFO</b>	
PCS.		QUANTITY PER M. CARTON: 12 M. CARTON WEIGHT (KG): 8,4 M. CARTON WEIGHT (LBS): 18,48 M. CARTON SIZE (M): 0,5X0,4X0,34 M. CARTON SIZE (INCH): 19,69 X 15,55 X 13,39	



**ELITE WAKE COMBO**

ITEM NUMBER	EAN CODE	HS CODE	FEATURES
211317013	PCS. 8718181230551	95062900	15 INCH/38.1 CM WIDE HANDLE 28MM THICK ROUND GRIP NYLON SUBLIMATED HANDLE
<b>SIZE</b>	<b>MASTER CARTON INFO</b>		
PCS.	QUANTITY PER M. CARTON: 16 M. CARTON WEIGHT (KG): 14,72 M. CARTON WEIGHT (LBS): 32,384 M. CARTON SIZE (M): 0,79 X 0,59 X 0,31 M. CARTON SIZE (INCH): 31,1 X 23,23 X 12,2		65FT/19.81 M MAIN LINE PENCIL FLOATS TO SUPPORT FLOATATION WAKEBOARD HANDLE AND ROPE



**FRONTIER WAKE HANDLE**

ITEM NUMBER	EAN CODE	HS CODE	FEATURES
211317016	PCS. 8718181214643	95062900	15 INCH/38.1 CM WIDE HANDLE 27,4MM THICK ROUND GRIP SOFT LEATHER PATTERN FOR A TACKY GRIP NYLON MOLDED END CAPS WAKEBOARD HANDLE
<b>SIZE</b>	<b>MASTER CARTON INFO</b>		
PCS.	QUANTITY PER M. CARTON: 24 M. CARTON WEIGHT (KG): 16,8 M. CARTON WEIGHT (LBS): 36,96 M. CARTON SIZE (M): 0,59X0,41X0,25 M. CARTON SIZE (INCH): 23,23X16,14X9,84		





**SPECTRA WAKE ROPE PVC COATED**

ITEM NUMBER	EAN CODE	HS CODE	FEATURES
211313007	PCS. 8718181122047	56090000	SHAPED PVC-COATED COVER. TOTAL LENGTH 80 FT./24.38 M WITH 5 SECTIONS. WEAR-FREE SNAG RESISTANT COVER WAKEBOARD ROPE
SIZE	MASTER CARTON INFO		
PCS.	QUANTITY PER M. CARTON: 30	M. CARTON WEIGHT (KG): 20,7	
	M. CARTON WEIGHT (LBS): 45,54	M. CARTON SIZE (M): 0,72X0,26X0,43	
	M. CARTON SIZE (INCH): 28,35X10,24X16,93		

**BASIC WAKEBOARD BAG**

<b>ITEM NUMBER</b>	<b>EAN CODE</b>	<b>HS CODE</b>	<b>FEATURES</b>
221319001	PCS. 8718181013789	42029291	SUPER STRONG 600D NYLON 145X50X7 CM EXTRA LONG ZIPPER WATER DRAINS
<b>SIZE</b>	<b>MASTER CARTON INFO</b>		
PCS.	<b>QUANTITY PER M. CARTON:</b> 10 <b>M. CARTON WEIGHT (KG):</b> 0,1 <b>M. CARTON WEIGHT (LBS):</b> 0,22 <b>M. CARTON SIZE (M):</b> 0,57X0,39X0,42 <b>M. CARTON SIZE (INCH):</b> 22,44X15,35X16,54		



### **PADDED WAKEBOARD BAG**

<b>ITEM NUMBER</b>	<b>EAN CODE</b>	<b>HS CODE</b>	<b>FEATURES</b>
221319002	PCS. 8718181013796	42029291	SUPER STRONG 600D NYLON 145X45X8 CM FULLY PADDED FOR MAX PROTECTION EASY-TO-CARRY COMFORTABLE SHOULDER STRAPS
<b>SIZE</b>	<b>MASTER CARTON INFO</b>		
PCS.	QUANTITY PER M. CARTON: 10 M. CARTON WEIGHT (KG): 0,1 M. CARTON WEIGHT (LBS): 0,22 M. CARTON SIZE (M): 0,6 X 0,52 X 0,6 M. CARTON SIZE (INCH): 23,62 X 20,47 X 23,62		



**WAKEBOARD TRAILER BAG**

ITEM NUMBER	EAN CODE	HS CODE	FEATURES
221319003	PCS. 8718181013802	42029291	SUPER STRONG 600D NYLON 155X47X2 CM FULLY PADDED
<b>SIZE</b>	<b>MASTER CARTON INFO</b>		
PCS.	QUANTITY PER M. CARTON: 2 M. CARTON WEIGHT (KG): 0,02 M. CARTON WEIGHT (LBS): 0,044 M. CARTON SIZE (M): 0,72X0,7X0,37 M. CARTON SIZE (INCH): 28,35X27,56X14,57		LOW RESISTANCE WHEELS WITH BEARINGS REINFORCED HANDLES CONVENIENT INNER POCKETS



**WAKESURF & WAKESKATE**

# SIZING WAKESURF & WAKESKATE

## WAKESKATES

	EXCEED 43"	EXCEED 45"	SAVAGE 43"	SAVAGE 45"
LENGTH (CM)	109	114	109	114
TIP / TAIL WIDTH	29,5 CM   11,6"	31 CM   12,2"	26 CM   10,2"	27,5 CM   10,8"
CENTER WIDTH	37,8 CM   14,9"	39 CM   15,4"	39,5 CM   15,6"	40,5   15,9"
WEIGHT (KG)	4,44	5	3,3	4,5
WEIGHT (LBS)	9,8	11	7,3	9,9
ROCKER	CONTINUOUS	CONTINUOUS	CONTINUOUS	CONTINUOUS
RIDER WEIGHT (KG)	60 AND UP	75 AND UP	60 AND UP	75 AND UP
RIDER WEIGHT (LBS)	132,3 AND UP	165,3 AND UP	132,3 AND UP	165,3 AND UP

## WAKESURFERS

	SHADE	ACCELERATE	EPEX
LENGTH	161,5 CM   63,3"	125 CM   49,2"	142 CM   55,9"
CENTER WIDTH	52 CM   20,5"	52 CM   20,5"	53,3 CM   21"
WEIGHT (KG)	>85	>80	>110
WEIGHT (LBS)	>187,4	>176,4	>242,5
ROCKER	2,5"	1,78"	1,5"

WE ARE CONSTANTLY WORKING ON THE SIZING OF OUR PRODUCTS. CHECK OUT [JOBESPORTS.COM](https://www.jobesports.com) FOR THE MOST UP TO DATE, IMPROVED SIZING! ALL MEASUREMENTS ARE FOR REFERENCE ONLY.





**SAVAGE WAKESKATE**

ITEM NUMBER	EAN CODE	HS CODE	FEATURES
572316001	109 8718181190268 114 8718181204163	95062900	PLYWOOD CONSTRUCTION. FULLY PADDED EVA DECK CONTINUOUS ROCKER 2 NYLON FINES
SIZE	MASTER CARTON INFO		
109   114	QUANTITY PER M. CARTON: 1 M. CARTON WEIGHT (KG): 5,39 M. CARTON WEIGHT (LBS): 11,858 M. CARTON SIZE (M): 1,13X0,43X0,11 M. CARTON SIZE (INCH): 44,5X17X4,25		



**EXCEED WAKESKATE**

ITEM NUMBER	EAN CODE	HS CODE	FEATURES
572516001	109 8718181190299 114 8718181204156	95062900	PLYWOOD CONSTRUCTION. FULLY PADDED CONCAVE EVA DECK CONTINUOUS ROCKER 2 NYLON FINS
SIZE	MASTER CARTON INFO		
109   114	QUANTITY PER M. CARTON: 1 M. CARTON WEIGHT (KG): 5,34 M. CARTON WEIGHT (LBS): 11,748 M. CARTON SIZE (M): 1,13X0,43X0,11 M. CARTON SIZE (INCH): 44,5X17X4,25		



# FOAM CORE TECHNOLOGY

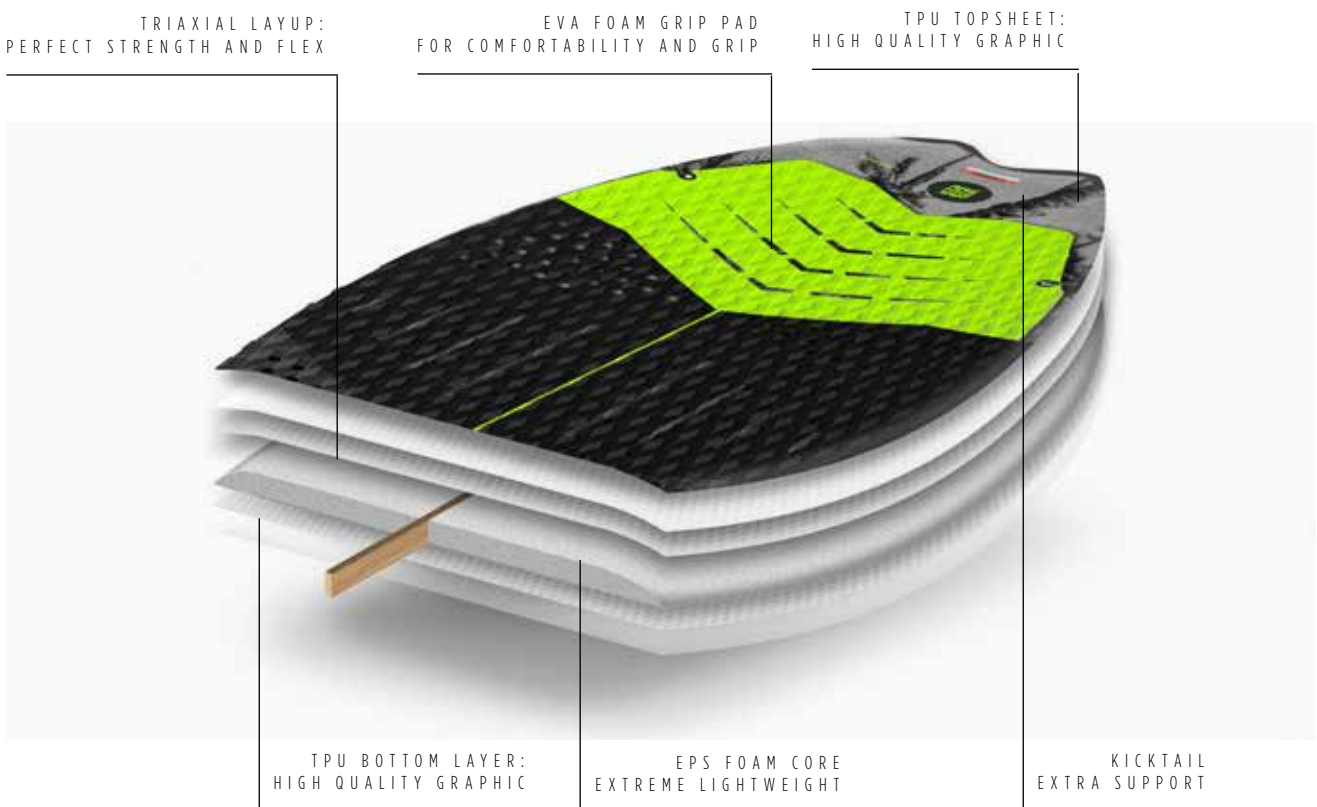
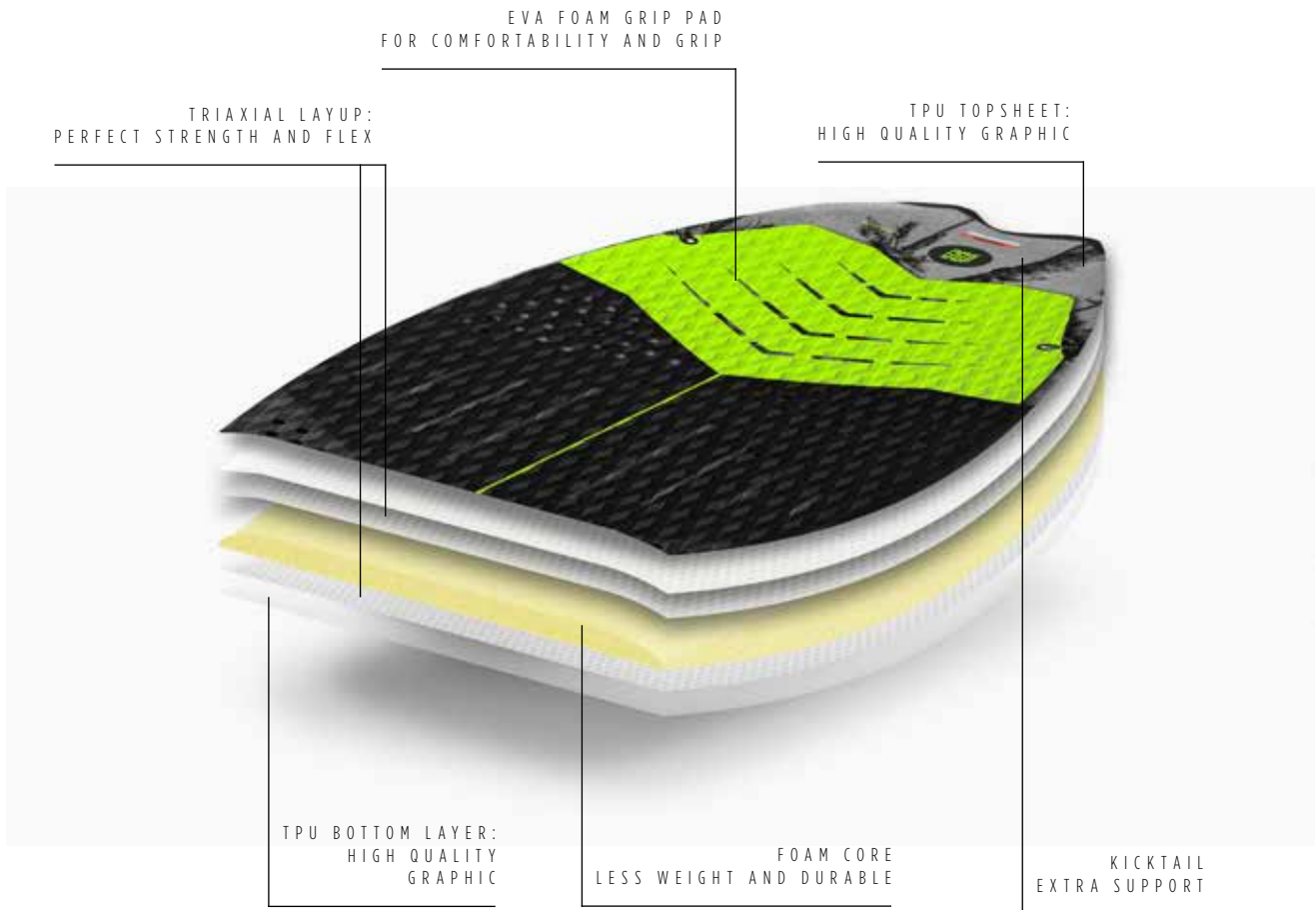



**ACCELERATE WAKESURFER**

ITEM NUMBER	EAN CODE	HS CODE	FEATURES
582519003	PCS. 8718181009935	95062900	TRADITIONAL FOAM CORE MACHINED GROOVED EVA DECK WITH EXTRA TALL TAIL KICK HIGH PRESS FIBERGLASS MOLDED WAKESURF/SKIM STYLE 2 NYLON FINS BEGINNERS AND INTERMEDIATE BOARD
<b>SIZE</b>		<b>MASTER CARTON INFO</b>	
PCS.		QUANTITY PER M. CARTON: 1 M. CARTON WEIGHT (KG): 5,09 M. CARTON WEIGHT (LBS): 11,2 M. CARTON SIZE (M): 1,28X0,56X0,07 M. CARTON SIZE (INCH): 50,39X22,05X2,76	PRODUCT SIZE 125*52CM PRODUCT SIZE: 49INCH X 21INCH X 7/8INCH RIDERS WEIGHT UP TO 80KG - 180LBS



**SHADE WAKESURFER**

ITEM NUMBER	EAN CODE	HS CODE	FEATURES
582519002	PCS. 8718181009928	95062900	TRADITIONAL FOAM CORE MACHINED GROOVED EVA DECK WITH EXTRA TALL TAIL KICK HIGH PRESS FIBERGLASS MOLDED TWO SIDE CHANNELS FOR A BETTER TRACTION INTO THE WAKE. WAKESURF STYLE
<b>SIZE</b>		<b>MASTER CARTON INFO</b>	
PCS.		QUANTITY PER M. CARTON: 1	3 NYLON FINS
		M. CARTON WEIGHT (KG): 4,53	BEGINNERS AND INTERMEDIATE BOARD
		M. CARTON WEIGHT (LBS): 9,97	PRODUCT SIZE: 161,5*52CM
		M. CARTON SIZE (M): 1,64X0,57X0,13	PRODUCT SIZE: 63" *20,5" INCH
		M. CARTON SIZE (INCH): 64,57X22,44X5,12	ROCKER: 2.5" UP TO 80KG - 180LBS



**EPEX WAKESURFER**

ITEM NUMBER	EAN CODE	HS CODE	FEATURES
582519001	PCS. 8718181009911	95062900	LIGHT WEIGHT MACHINED EPS FOAM CORE MACHINED GROOVED EVA DECK WITH EXTRA TALL TAIL KICK HAND MADE VACUUM MOLDED WAKESURF STYLE 3 NYLON FINES BEGINNERS AND INTERMEDIATE BOARD
<b>SIZE</b>		<b>MASTER CARTON INFO</b>	
PCS.		QUANTITY PER M. CARTON: 1	PRODUCT SIZE: 142,2CM*52,6CM
		M. CARTON WEIGHT (KG): 4,53	PRODUCT SIZE: 56" *20,5" INCH
		M. CARTON WEIGHT (LBS): 9,966	ROCKER: 2.5"
		M. CARTON SIZE (M): 1,45X0,55X0,05	UP TO 80KG - 180LBS
		M. CARTON SIZE (INCH): 57,09X21,65X1,97	



**WAKESURF ROPE**

ITEM NUMBER	EAN CODE	HS CODE	FEATURES
211519001	PCS. 8718181001304	95062900	10 INCH/25.4 CM WIDE HANDLE EVA PROFILED HANDLE GRIP 24FT/7.31 M MAIN LINE WITH 3 EXTENSIONS PENCIL FLOATS TO SUPPORT FLOATATION WAKESURF ROPE
<b>SIZE</b>	<b>MASTER CARTON INFO</b>		
PCS.	QUANTITY PER M. CARTON: 10 M. CARTON WEIGHT (KG): 9,8 M. CARTON WEIGHT (LBS): 21,56 M. CARTON SIZE (M): 0,54X0,29X0,48 M. CARTON SIZE (INCH): 21,06X11,22X18,7		

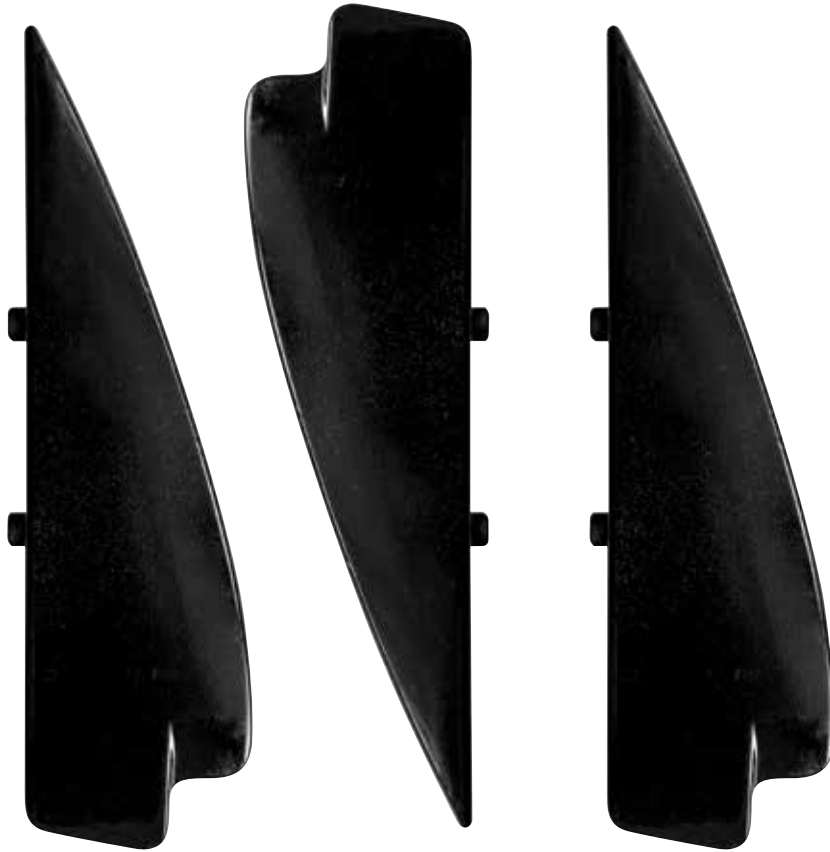

**WAKESURF FIN SET**

<i>ITEM NUMBER</i>	<i>EAN CODE</i>	<i>HS CODE</i>	<i>FEATURES</i>
589918001	PCS. 8718181256094	95062900	NYLON SET OF 3
<b>SIZE</b>		<b>MASTER CARTON INFO</b>	
PCS.		QUANTITY PER M. CARTON: M. CARTON WEIGHT (KG): M. CARTON WEIGHT (LBS): M. CARTON SIZE (M): M. CARTON SIZE (INCH):	



**HELMETS**

# SIZING HELMETS

## HELMETS

	VICTOR (CM)	VICTOR (INCH)	BASE (CM)	BASE (INCH)
XSMALL	-	-	52 - 53 CM	20,5-20,9
SMALL	53 - 54 CM	20,9-21,3	54 - 55 CM	21,3-21,7
MEDIUM	55 - 56 CM	21,7-22	56 - 57 CM	22-22,4
LARGE	57 - 58 CM	22,4-22,8	58 - 59 CM	22,8-23,2
XLARGE	59 - 60 CM	23,2-23,6	60 - 61 CM	23,6-24

WE ARE CONSTANTLY WORKING ON THE SIZING OF OUR PRODUCTS. CHECK OUT [JOBESPORTS.COM](https://www.jobesports.com) FOR THE MOST UP TO DATE, IMPROVED SIZING! ALL MEASUREMENTS ARE FOR REFERENCE ONLY.

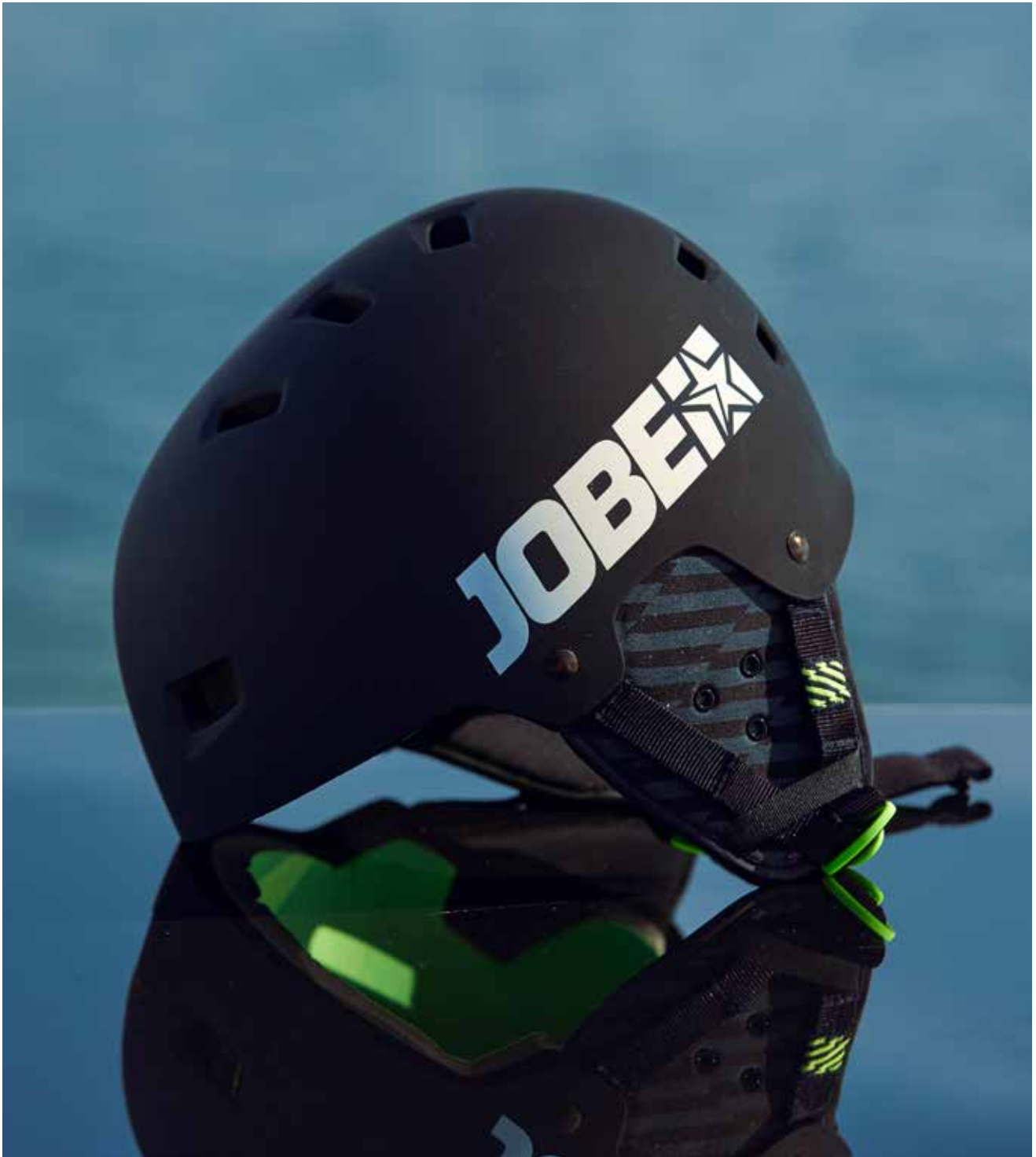





**VICTOR HELMET BLACK**

ITEM NUMBER	EAN CODE	HS CODE	FEATURES
370018001	S 8718181256308 M 8718181256292 L 8718181256285	65061010	ADJUSTABLE CHIN STRAP REMOVABLE FIT PADS PROTECTIVE EAR PADS
<b>SIZE</b>	XL 8718181256315	<b>MASTER CARTON INFO</b>	
S   M   L   XL		QUANTITY PER M. CARTON: 5 M. CARTON WEIGHT (KG): 4,3 M. CARTON WEIGHT (LBS): 9,46 M. CARTON SIZE (M): 0,92X0,29X0,24 M. CARTON SIZE (INCH): 36,02X11,22X9,25	



**BASE HELMET TEAL BLUE**

ITEM NUMBER	EAN CODE	HS CODE	FEATURES
370017002	S 8718181243445 M 8718181243438 L 8718181243421 XL 8718181243452	65061010	ADJUSTABLE CHIN STRAP PROTECTIVE EAR PADS LIGHTWEIGHT HELMET DUAL DENSITY RING LINER. SOFT AND COMFORTABLE FIT.
<b>SIZE</b>		<b>MASTER CARTON INFO</b>	
S   M   L   XL		QUANTITY PER M. CARTON: 5 M. CARTON WEIGHT (KG): 3,2 M. CARTON WEIGHT (LBS): 7,04 M. CARTON SIZE (M): 0,92X0,29X0,24 M. CARTON SIZE (INCH): 36,02X11,22X9,25	



**BASE HELMET DARK TEAL**

ITEM NUMBER	EAN CODE	HS CODE	FEATURES
370018002	XS 8718181000604 S 8718181000581 M 8718181000574	65061010	ADJUSTABLE CHIN STRAP PROTECTIVE EAR PADS LIGHTWEIGHT HELMET DUAL DENSITY RING LINER. SOFT AND COMFORTABLE FIT.
<b>SIZE</b>	L 8718181000543 XL 8718181000536	<b>MASTER CARTON INFO</b>	
XS   S   M   L   XL		QUANTITY PER M. CARTON: 5 M. CARTON WEIGHT (KG): 4,62 M. CARTON WEIGHT (LBS): 10,164 M. CARTON SIZE (M): 0,92X0,29X0,24 M. CARTON SIZE (INCH): 36,02X11,22X9,25	



**BASE HELMET BORDEAUX RED**

ITEM NUMBER	EAN CODE	HS CODE	FEATURES
370019002	XS 8718181006910 S 8718181006903 M 8718181006897	65061010	ADJUSTABLE CHIN STRAP PROTECTIVE EAR PADS LIGHTWEIGHT HELMET DUAL DENSITY RING LINER. SOFT AND COMFORTABLE FIT.
<b>SIZE</b>		<b>MASTER CARTON INFO</b>	
XS   S   M		QUANTITY PER M. CARTON: 5 M. CARTON WEIGHT (KG): 3,15 M. CARTON WEIGHT (LBS): 6,93 M. CARTON SIZE (M): 0,92X0,29X0,24 M. CARTON SIZE (INCH): 36,02X11,22X9,25	



**BASE HELMET BLACK**

ITEM NUMBER	EAN CODE	HS CODE	FEATURES
370017001	XS 8718181243414 S 8718181243407 M 8718181243391	65061010	ADJUSTABLE CHIN STRAP PROTECTIVE EAR PADS LIGHTWEIGHT HELMET DUAL DENSITY RING LINER. SOFT AND COMFORTABLE FIT.
<b>SIZE</b>	L 8718181243377 XL 8718181243384	<b>MASTER CARTON INFO</b>	
XS   S   M   L   XL		QUANTITY PER M. CARTON: 5 M. CARTON WEIGHT (KG): 3,85 M. CARTON WEIGHT (LBS): 8,47 M. CARTON SIZE (M): 0,92X0,29X0,24 M. CARTON SIZE (INCH): 36,02X11,22X9,25	





**MULTIPOSITION - & KNEEBOARDS**

# SIZING MULTI POSITION- & KNEEBOARDS

## MULTI POSITION BOARDS

	CHIPPER	STIMMEL	OMNIA
LENGTH	100 CM   39,4"	135 CM   53,1"	147 CM   57,9"
WIDTH	100 CM   39,4"	57 CM   22,4"	59 CM   23,2"
WEIGHT (KG)	7	7	5,8
WEIGHT (LBS)	15,4	15,4	12,8
BINDINGS	NO	NO	YES
FINS	NO	YES	NO
PLASTIC HANDLE	NO	YES	YES
HANDLE + ROPE	YES	NO	NO

## KNEEBOARDS

	STAGE	PROPHECY	SENTRY	STREAK
LENGTH	132 CM   52"	138 CM   54,3"	132 CM   52"	133 CM   52,4"
WIDTH	53 CM   20,9"	51 CM   20,1"	51,56 CM   20,3"	50 CM   19,7"
WEIGHT (KG)	4,5	8,75	7,26	6
WEIGHT (LBS)	9,9	19,3	16	13,2
STRAP	DOUBLE LOCK	DOUBLE LOCK	SINGLE LOCK	SINGLE LOCK
FINS	NONE	INMOLDED	MOLDED	MOLDED
HYDROHOOK	NO	NO	YES	YES

WE ARE CONSTANTLY WORKING ON THE SIZING OF OUR PRODUCTS. CHECK OUT [JOBESPORTS.COM](https://www.jobesports.com) FOR THE MOST UP TO DATE, IMPROVED SIZING! ALL MEASUREMENTS ARE FOR REFERENCE ONLY.







► TRANSPARENT KNEEBOARD BAG

► UNIVERSAL VEST BLUE

► TOW HOOK HANDLE

**STREAK KNEEBOARD BLUE PACKAGE**

ITEM NUMBER	EAN CODE	HS CODE	FEATURES
258819002	PCS. 8718181003421	95062900	<p><b>BOARD</b> FULLY PADDED SINGLE KNEEBOARD STRAP   COMFORTABLE FOAM KNEE PAD   MOLDED FINS FOR EXTRA TRACTION   EASY START HANDLE HOOK   RIDERS WEIGHT &gt;100KG</p> <p><b>VEST</b> 50N ISO-CERTIFIED (BUOYANCY AID)   LIGHTWEIGHT PE-FOAM   STRONG &amp; LIGHTWEIGHT NYLON FABRIC ADJUSTABLE SIZING DUE TO OPEN SIDES</p> <p><b>HANDLE</b> EVA PROFILED HANDLE GRIP   65FT MAIN LINE WITH 2 EXTENSIONS 5FT   SUPER-DURABLE RUBBER TOW HOOK HANDLE FOR EASY STARTS</p>
SIZE	MASTER CARTON INFO		
PCS.	QUANTITY PER M. CARTON:	1	
	M. CARTON WEIGHT (KG):	9,46	
	M. CARTON WEIGHT (LBS):	20,812	
	M. CARTON SIZE (M):	0X0X0	
	M. CARTON SIZE (INCH):	0X0X0	



▶ TRANSPARENT KNEEBOARD BAG



▶ UNIVERSAL VEST RED



▶ TOW HOOK HANDLE

**STREAK KNEEBOARD RED PACKAGE**

ITEM NUMBER	EAN CODE	HS CODE	FEATURES
258819001	PCS. 8718181003414	95062900	<p><b>BOARD</b> FULLY PADDED SINGLE KNEEBOARD STRAP   COMFORTABLE FOAM KNEE PAD   MOLDED FINS FOR EXTRA TRACTION   EASY START HANDLE HOOK   RIDERS WEIGHT &gt;100KG</p> <p><b>VEST</b> 50N ISO-CERTIFIED (BUOYANCY AID)   LIGHTWEIGHT PE-FOAM   STRONG &amp; LIGHTWEIGHT NYLON FABRIC   ADJUSTABLE SIZING DUE TO OPEN SIDES</p> <p><b>HANDLE</b> EVA PROFILED HANDLE GRIP   65FT MAIN LINE WITH 2 EXTENSIONS 5FT   SUPER-DURABLE RUBBER TOW HOOK HANDLE FOR EASY STARTS</p>
SIZE	MASTER CARTON INFO		
PCS.	<p>QUANTITY PER M. CARTON: 1</p> <p>M. CARTON WEIGHT (KG): 9,46</p> <p>M. CARTON WEIGHT (LBS): 20,812</p> <p>M. CARTON SIZE (M): 0X0X0</p> <p>M. CARTON SIZE (INCH): 0X0X0</p>		



▶ TRANSPARENT KNEEBOARD BAG

▶ UNIVERSAL VEST LIME GREEN

▶ TOW HOOK HANDLE

**SENTRY KNEEBOARD PACKAGE**

ITEM NUMBER	EAN CODE	HS CODE	FEATURES
258819003	PCS. 8718181003438	95062900	<p><b>BOARD</b> FULLY PADDED SINGLE KNEEBOARD STRAP   COMFORTABLE FOAM KNEE PAD   MOLDED FINS FOR EXTRA TRACTION   EASY START HANDLE HOOK   MAX RIDERS WEIGHT 120KG</p> <p><b>VEST</b> 50N ISO-CERTIFIED (BUOYANCY AID) LIGHTWEIGHT PE-FOAM   STRONG &amp; LIGHTWEIGHT NYLON FABRIC   ADJUSTABLE SIZING DUE TO OPEN SIDES</p> <p><b>HANDLE</b> EVA PROFILED HANDLE GRIP   65FT MAIN LINE WITH 2 EXTENSIONS 5FT   SUPER-DURABLE RUBBER TOW HOOK HANDLE FOR EASY STARTS</p>
SIZE	MASTER CARTON INFO		
PCS.	<p>QUANTITY PER M. CARTON: 1</p> <p>M. CARTON WEIGHT (KG): 9,46</p> <p>M. CARTON WEIGHT (LBS): 20,812</p> <p>M. CARTON SIZE (M): 0X0X0</p> <p>M. CARTON SIZE (INCH): 0X0X0</p>		



**STREAK KNEEBOARD BLUE**

ITEM NUMBER	EAN CODE	HS CODE	FEATURES
252519002	PCS. 8718181003384	95062900	PLASTIC ROTOMOLDED FULLY PADDED SINGLE KNEEBOARD STRAP COMFORTABLE FOAM KNEE PAD MOLDED FINS FOR EXTRA TRACTION EASY START HANDLE HOOK TWIN TIP RIDERS WEIGHT > 100KG LENGTH 133CM
SIZE	MASTER CARTON INFO		
PCS.	QUANTITY PER M. CARTON:	1	
	M. CARTON WEIGHT (KG):	5,69	
	M. CARTON WEIGHT (LBS):	12,52	
	M. CARTON SIZE (M):	1,3X0,52X0,13	
	M. CARTON SIZE (INCH):	51,18X20,47X4,92	



**STREAK KNEEBOARD RED**

ITEM NUMBER	EAN CODE	HS CODE	FEATURES
252519001	PCS. 8718181003377	95062900	PLASTIC ROTOMOLDED FULLY PADDED SINGLE KNEEBOARD STRAP COMFORTABLE FOAM KNEE PAD MOLDED FINS FOR EXTRA TRACTION EASY START HANDLE HOOK TWIN TIP RIDERS WEIGHT >100KG LENGTH 133CM
SIZE	MASTER CARTON INFO		
PCS.	QUANTITY PER M. CARTON: 1 M. CARTON WEIGHT (KG): 5,69 M. CARTON WEIGHT (LBS): 12,518 M. CARTON SIZE (M): 1,3X0,52X0,13 M. CARTON SIZE (INCH): 51,18X20,47X4,92		



**SENTRY KNEEBOARD**

ITEM NUMBER	EAN CODE	HS CODE	FEATURES
252719001	PCS. 8718181003407	95062900	PLASTIC ROTOMOLDED FULLY PADDED SINGLE KNEEBOARD STRAP COMFORTABLE FOAM KNEE PAD MOLDED FINN FOR EXTRA TRACTION EASY START HANDLE HOOK TWIN TIP MAX RIDERS WEIGHT 120KG LENGTH 132CM
SIZE	<b>MASTER CARTON INFO</b>		
PCS.	QUANTITY PER M. CARTON: 1 M. CARTON WEIGHT (KG): 7,16 M. CARTON WEIGHT (LBS): 15,75 M. CARTON SIZE (M): 1,38X0,55X0,15 M. CARTON SIZE (INCH): 54,13X21,65X5,71		



**PROPHECY KNEEBOARD**

ITEM NUMBER	EAN CODE	HS CODE	FEATURES
252319001	PCS. 8718181003353	95062900	TRADITIONAL FOAM CORE. FULLY PADDED SINGLE KNEEBOARD STRAP HIGH PRESS FIBERGLASS MOLDED COMFORTABLE FOAM KNEE PAD IN MOLDED FINS FOR EXTRA TRACTION
<b>SIZE</b>	<b>MASTER CARTON INFO</b>		
PCS.	QUANTITY PER M. CARTON: 1 M. CARTON WEIGHT (KG): 8,18 M. CARTON WEIGHT (LBS): 18 M. CARTON SIZE (M): 1,5X0,62X0,1 M. CARTON SIZE (INCH): 59,06X24,41X3,94		



**STAGE KNEEBOARD**

ITEM NUMBER	EAN CODE	HS CODE	FEATURES
252319002	PCS. 8718181003360	95062900	LIGHTWEIGHT WOOD FOAM CORE FULLY PADDED SINGLE KNEEBOARD STRAP ABS PROTECTING SIDEWALLS HIGH PRESS FIBERGLASS MOLDED FLEX CONSTRUCTION COMFORTABLE FOAM KNEE PAD
SIZE	MASTER CARTON INFO		
PCS.	QUANTITY PER M. CARTON: 1 M. CARTON WEIGHT (KG): 7,41 M. CARTON WEIGHT (LBS): 16,302 M. CARTON SIZE (M): 1,5X0,62X0,1 M. CARTON SIZE (INCH): 59,06X24,41X3,94		





► BOTTOM DESIGN



► INCL. CHIPPER HANDLE

**CHIPPER MULTI POSITION BOARD WITH CHIPPER HANDLE**

ITEM NUMBER	EAN CODE	HS CODE	FEATURES
252518001	PCS. 8718181247863	95062900	BOARD INCLUDES ROPE AND HANDLE PLASTIC ROTOMOLDED TOW POINT FOR EASY STARTS AND TOWING. NYLON WEBBING SIDE HANDLE COMFORTABLE EVA TRACTION PAD PROVIDES A GREAT FOOTHOLD
SIZE	MASTER CARTON INFO		CHANNEL BOTTOM DESIGN ALL-IN-ONE PRODUCT SIZE: 100CM
PCS.	QUANTITY PER M. CARTON:	1	
	M. CARTON WEIGHT (KG):	7,7	
	M. CARTON WEIGHT (LBS):	16,94	
	M. CARTON SIZE (M):	1,03X1,03X0,14	
	M. CARTON SIZE (INCH):	40,55X40,55X5,31	



**CHIPPER HANDLE**

ITEM NUMBER	EAN CODE	HS CODE	FEATURES
211218001	PCS. 8718181247870	95062900	
<b>SIZE</b>	<b>MASTER CARTON INFO</b>		
PCS.	QUANTITY PER M. CARTON: 16 M. CARTON WEIGHT (KG): 7,04 M. CARTON WEIGHT (LBS): 15,488 M. CARTON SIZE (M): 0,51X0,32X0,41 M. CARTON SIZE (INCH): 20,08X12,6X16,06		



► REMOVABLE SURF FINs

**STIMMEL MULTI POSITION BOARD**

ITEM NUMBER	EAN CODE	HS CODE	FEATURES
252517208	PCS. 8718181214674	95062900	PLASTIC ROTOMOLDED REMOVABLE SURF FINs INJECTION MOLDED SIDE HANDLE WITH INTEGRATED TOW HOOK COMFORTABLE ANTI SLIP EVA DECK. MANEUVERABLE SHAPE ALL-IN-ONE PRODUCT
<b>SIZE</b>		<b>MASTER CARTON INFO</b>	WEIGHT: 7KG DIMENSIONS: 1,35MX0,57MX0,05M
PCS.		QUANTITY PER M. CARTON: 1 M. CARTON WEIGHT (KG): 9,17 M. CARTON WEIGHT (LBS): 20,17 M. CARTON SIZE (M): 1,53X0,64X0,13 M. CARTON SIZE (INCH): 60,24X25X5,12	



**OMNIA MULTI POSITION BOARD**

ITEM NUMBER	EAN CODE	HS CODE	FEATURES
252317107	PCS. 8718181214667	95062900	TRADITIONAL FOAM CORE HIGH PRESS FIBERGLASS MOLDED THIN PROFILE MANEUVERABLE SHAPE INJECTION MOLDED SIDE HANDLE WITH INTEGRATED TOW HOOK EASY SLIP-IN FOOT STRAPS COMFORTABLE ANTI-SLIP EVA DECK. ALL-IN-ONE PRODUCT WEIGHT 12,8LBS 5,8KG DIMENSIONS: 58INL X 23.25INW X 3.5INH
SIZE	MASTER CARTON INFO		
PCS.	QUANTITY PER M. CARTON:	1	
	M. CARTON WEIGHT (KG):	7,7	
	M. CARTON WEIGHT (LBS):	16,94	
	M. CARTON SIZE (M):	1,50 X 0,62 X 0,10	
	M. CARTON SIZE (INCH):	59,06 X 24,41 X 3,94	



**TOW HOOK HANDLE**

ITEM NUMBER	EAN CODE	HS CODE	FEATURES
211217010	PCS. 8718181209465	95062900	15 INCH/38.1 CM WIDE HANDLE 27,4MM THICK ROUND GRIP EVA PROFILED HANDLE GRIP
<b>SIZE</b>	<b>MASTER CARTON INFO</b>		
PCS.	QUANTITY PER M. CARTON: 16 M. CARTON WEIGHT (KG): 12,32 M. CARTON WEIGHT (LBS): 27,104 M. CARTON SIZE (M): 0,79X0,49X0,28 M. CARTON SIZE (INCH): 3,1X19,29X10,83		12 STRAND MAIN LINE 65FT/19.81 M MAIN LINE WITH 2 EXTENSIONS 5FT/1.5 M SUPER-DURABLE RUBBER TOW HOOK HANDLE FOR EASY STARTS FITS THE JOBE OMNIA AND STIMMEL





### MULTI POSITION BOARD BAG

ITEM NUMBER	EAN CODE	HS CODE	FEATURES
220019004	PCS. 8718181013734	42029291	SUPER STRONG 600D NYLON 150CM X 60CM X 14CM PADDED SIDES PROTECTION VENTILATION MESH FITS MOST TYPE OF KNEEBOARDS
SIZE	MASTER CARTON INFO		
PCS.	QUANTITY PER M. CARTON:	15	
	M. CARTON WEIGHT (KG):	13,2	
	M. CARTON WEIGHT (LBS):	29,04	
	M. CARTON SIZE (M):	0,69 X 0,42 X 0,53	
	M. CARTON SIZE (INCH):	27,17 X 16,54 X 20,87	

























**TOWABLES**

# TOWABLE OVERVIEW

	YOUTH	DONUTS				SOFAS
1 PERSON	 PARROT TRAINER	 HOTSEAT	 RUMBLE	 CRUSHER	 THUNDER	 ANURA
2 PERSONS				 DOUBLE TROUBLE	 ANURA	 BINAR
3 PERSONS		 GIANT		 TRIPLET	 ANURA	 LUNAR
4 PERSONS						 SONAR
5+ PERSONS						



DECKS	EXTREME			WATERSLEDS		
 <i>BREEZE</i>  <i>REVOLVE</i>	 <i>HYDRA</i>  <i>SUNRAY</i>  <i>WINGMAN</i>					
 <i>STORM</i>  <i>AIRSTREAM</i>  <i>REVOLVE</i>  <i>SCOUT</i>		 <i>KICKFLIP</i>  <i>TRIBAL</i>		 <i>CHASER</i>		
 <i>TORNADO</i>  <i>AIRSTREAM</i>  <i>REVOLVE</i>  <i>SCOUT</i>  <i>SEA-ESTA</i>			 <i>TRIBAL</i>		 <i>CHASER</i>	
 <i>AIRSTREAM</i>					 <i>CHASER</i>	
		 <i>SCOUT</i>				

# TOWABLE TECHNOLOGY

NEOPRENE PADS  
FOR A COMFORTABLE RIDE  
GLUED AND STITCHED TO  
THE COVER

BOSTON VALVE FOR  
QUICK INFLATION  
AND DEFLATION

DENIERS VARY FROM 420D  
FOR A 1/2 PERSON TUBE,  
840D FOR A 2/3 PERSON  
TUBE AND 1680D FOR  
COMMERCIAL USED PRODUCTS.

GAUGES VARY FROM 16G  
(KIDS TUBES), 24G (1/2  
PERSON TUBE), 30G (2/3  
PERSON TUBE) AND 34G FOR  
COMMERCIAL PRODUCTS.



FOAM FILLED  
HANDLES WITH  
NEOPRENE  
KNUCKLEGUARDS  
FOR MAXIMUM  
GRIP AND COMFORT

NYLON REINFORCEMENT  
PATCHES BEHIND THE  
HANDLES:  
EXTRA DURABLE DUE  
TO THE REINFORCEMENT

NYLON REINFORCEMENT PATCHES  
BEHIND THE TOWPOINT:  
A DURABLE AND STRONG  
TOWPOINT

EASY ENTRY  
WEBBING HANDLES  
GET BACK ON THE  
TOWABLE WITHOUT  
ANY PROBLEM

QUICK CONNECTOR BUCKLE  
TO CONNECT THE  
TOWROPE IN A FEW SECONDS



### PARROT TRAINER TOWABLE 1P

ITEM NUMBER	EAN CODE	HS CODE	FEATURES
230116003	PCS. 8718181180511	95062900	420 DENIER NYLON COVER 24 GAUGE PVC MAX 1 PERSON TOWABLE ONE WAY BOSTON VALVE QUICK ROPE CONNECTOR 2 WEBBING HANDLES DETACHABLE HANDLE MULTI-POSITION TOWABLE EASY BOARDING DOUBLE-STITCHED NYLON DEFLATED SIZE : 60" X 49", 153 X 126CM 3 YEAR WARRANTY AFTER REGISTRATION
SIZE	MASTER CARTON INFO		
PCS.	QUANTITY PER M. CARTON:	3	
	M. CARTON WEIGHT (KG):	15,45	
	M. CARTON WEIGHT (LBS):	33,99	
	M. CARTON SIZE (M):	0,47 X 0,35 X 0,4	
	M. CARTON SIZE (INCH):	18,5 X 13,78 X 15,75	



► FOOTPUMP



► 1P TOWROPE



► SKI FLAG



► QUICK RELEASE

**RUMBLE TOWABLE PACKAGE 1P**

ITEM NUMBER	EAN CODE	HS CODE	FEATURES
238817001	PCS. 8718181209854	95062900	420 DENIER NYLON COVER 24 GAUGE PVC BOSTON VALVE MULTI-POSITION TOWABLE 1 PERSON TOWABLE PARTIALLY COVERED QUICK CONNECTOR 4 HANDLES WITH NEOPRENE KNUCKLE GUARDS SAFETY CHAMBER 1 WATER DRAIN DEFLATED SIZE - 54"   137CM INCLUDING PUMP, LEASH, SKI FLAG AND QUICK RELEASE WRIST SEAL
SIZE	MASTER CARTON INFO		
PCS.	QUANTITY PER M. CARTON:	4	
	M. CARTON WEIGHT (KG):	19,68	
	M. CARTON WEIGHT (LBS):	43,296	
	M. CARTON SIZE (M):	0,47 X 0,32 X 0,53	
	M. CARTON SIZE (INCH):	18,5 X 12,6 X 20,87	



► FOOTPUMP



► 1P TOWROPE



► SKI FLAG



► QUICK RELEASE

### THUNDER TOWABLE PACKAGE 1P

ITEM NUMBER	EAN CODE	HS CODE	FEATURES
238817004	PCS. 8718181209878	95062900	420 DENIER NYLON COVER   24 GAUGE PVC 4 HANDLES WITH NEOPRENE KNUCKLE GUARDS BOSTON VALVE MULTI-POSITION TOWABLE 1 PERSON TOWABLE PARTIALLY COVERED QUICK CONNECTOR SAFETY CHAMBER 1 WATER DRAIN DEFLATED SIZE : 53.5" X 55.5"   136 X 141 CM INCLUDING PUMP, LEASH, SKI FLAG AND QUICK RELEASE WRIST SEAL
SIZE	MASTER CARTON INFO		
PCS.	QUANTITY PER M. CARTON:	4	
	M. CARTON WEIGHT (KG):	20,12	
	M. CARTON WEIGHT (LBS):	44,264	
	M. CARTON SIZE (M):	0,47 X 0,32 X 0,53	
	M. CARTON SIZE (INCH):	18,5 X 12,6 X 20,87	



► FOOTPUMP



► 1P TOWROPE



► SKI FLAG



► QUICK RELEASE

**HYDRA TOWABLE PACKAGE 1P**

ITEM NUMBER	EAN CODE	HS CODE	FEATURES
238819001	PCS. 8718181013840	95062900	420 DENIER NYLON COVER 20 GAUGE PVC 2 HANDLES WITH NEOPRENE KNUCKLE GUARDS MAX 1 PERSONS TOWABLE QUICK ROPE CONNECTOR DEFLATED SIZE : 54" X 35", 137 X 89CM FOOT PUMP 1 PERSON TOWROPE ORANGE SKI FLAG QUICK RELEASE WITH WRIST SEAL
SIZE	MASTER CARTON INFO		
PCS.	QUANTITY PER M. CARTON:	4	
	M. CARTON WEIGHT (KG):	0,04	
	M. CARTON WEIGHT (LBS):	0,088	
	M. CARTON SIZE (M):	0,55 X 0,32 X 0,53	
	M. CARTON SIZE (INCH):	21,65 X 12,6 X 20,87	



**3 YEARS  
WARRANTY**





**RUMBLE TOWABLE 1P**

ITEM NUMBER	EAN CODE	HS CODE	FEATURES
230117001	PCS. 8718181209694	95062900	420 DENIER NYLON COVER 24 GAUGE PVC MAX 1 PERSON TOWABLE ONE WAY BOSTON VALVE QUICK ROPE CONNECTOR 4 HANDLES WITH NEOPRENE KNUCKLE GUARDS DOUBLE-STITCHED NYLON DEFLATED SIZE : Ø 54", 137CM 3 YEAR WARRANTY AFTER REGISTRATION
SIZE	MASTER CARTON INFO		
PCS.	QUANTITY PER M. CARTON:	6	
	M. CARTON WEIGHT (KG):	21,6	
	M. CARTON WEIGHT (LBS):	47,52	
	M. CARTON SIZE (M):	0,32X0,41X0,64	
	M. CARTON SIZE (INCH):	12,6X16,14X25,2	



**THUNDER TOWABLE 1P**

<i>ITEM NUMBER</i>	<i>EAN CODE</i>	<i>HS CODE</i>	<i>FEATURES</i>
230117004	PCS. 8718181209717	95062900	420 DENIER NYLON COVER 24 GAUGE PVC MAX 1 PERSON TOWABLE ONE WAY BOSTON VALVE QUICK ROPE CONNECTOR
<b>SIZE</b>		<b>MASTER CARTON INFO</b>	
PCS.		QUANTITY PER M. CARTON: 4 M. CARTON WEIGHT (KG): 15,96 M. CARTON WEIGHT (LBS): 35,11 M. CARTON SIZE (M): 0,66 X 0,34 X 0,31 M. CARTON SIZE (INCH): 26 X 13,25 X 12,25	4 HANDLES WITH NEOPRENE KNUCKLE GUARDS SAFETY CHAMBER DOUBLE-STITCHED NYLON DEFLATED SIZE : 53.5" X 55.5", 136 X 141CM 3 YEAR WARRANTY AFTER REGISTRATION



**CRUSHER TOWABLE 1P**

ITEM NUMBER	EAN CODE	HS CODE	FEATURES
230118001	PCS. 8718181247702	95062900	420 DENIER NYLON COVER 24 GAUGE PVC MAX 1 PERSON TOWABLE ONE WAY BOSTON VALVE QUICK ROPE CONNECTOR 4 HANDLES WITH NEOPRENE KNUCKLE GUARDS COMFORTABLE CUSHION SAFETY CHAMBER DOUBLE-STITCHED NYLON DEFLATED SIZE : Ø56", 142CM 3 YEAR WARRANTY AFTER REGISTRATION
<b>SIZE</b>		<b>MASTER CARTON INFO</b>	
PCS.		QUANTITY PER M. CARTON: 4 M. CARTON WEIGHT (KG): 17,32 M. CARTON WEIGHT (LBS): 38,1 M. CARTON SIZE (M): 0,41X0,48X0,33 M. CARTON SIZE (INCH): 16,14X18,9X12,99	



### HYDRA TOWABLE 1P

ITEM NUMBER	EAN CODE	HS CODE	FEATURES
230119004	PCS. 8718181013833	95062900	420 DENIER NYLON COVER 20 GAUGE PVC MAX 1 PERSON TOWABLE QUICK ROPE CONNECTOR 2 HANDLES WITH NEOPRENE KNUCKLE GUARDS DOUBLE-STITCHED NYLON DEFLATED SIZE : 54" X 35", 137 X 89CM 3 YEAR WARRANTY AFTER REGISTRATION
<b>SIZE</b>		<b>MASTER CARTON INFO</b>	
PCS.		QUANTITY PER M. CARTON: 6 M. CARTON WEIGHT (KG): 0,06 M. CARTON WEIGHT (LBS): 0,13 M. CARTON SIZE (M): 0,32X0,41X0,64 M. CARTON SIZE (INCH): 12,6X16,14X25,2	



**BREEZE TOWABLE 1P**

ITEM NUMBER	EAN CODE	HS CODE	FEATURES
230117005	PCS. 8718181209670	95062900	420 DENIER NYLON COVER 24 GAUGE PVC MAX 1 PERSON TOWABLE ONE WAY BOSTON VALVE QUICK ROPE CONNECTOR 4 HANDLES WITH NEOPRENE KNUCKLE GUARDS 2 NEOPRENE HANDLES NEOPRENE SEAT PADS DOUBLE-STITCHED NYLON DEFLATED SIZE : Ø 54" , 137CM 3 YEAR WARRANTY AFTER REGISTRATION
SIZE	MASTER CARTON INFO		
PCS.	QUANTITY PER M. CARTON:	4	
	M. CARTON WEIGHT (KG):	20	
	M. CARTON WEIGHT (LBS):	44	
	M. CARTON SIZE (M):	0,47X0,46 X0,37	
	M. CARTON SIZE (INCH):	18,5X18,11X14,57	



### HOTSEAT TOWABLE 1P

ITEM NUMBER	EAN CODE	HS CODE	FEATURES
230118002	PCS. 8718181247719	95062900	840 DENIER NYLON COVER 26 GAUGE PVC MAX 1 PERSON TOWABLE ONE WAY BOSTON VALVE QUICK ROPE CONNECTOR 4 HANDLES WITH NEOPRENE KNUCKLE GUARDS SAFETY CHAMBER DOUBLE-STITCHED NYLON DEFLATED SIZE : Ø58   147CM 3 YEAR WARRANTY AFTER REGISTRATION
SIZE	MASTER CARTON INFO		
PCS.	QUANTITY PER M. CARTON:	3	
	M. CARTON WEIGHT (KG):	13,26	
	M. CARTON WEIGHT (LBS):	29,17	
	M. CARTON SIZE (M):	0,47X0,43X0,37	
	M. CARTON SIZE (INCH):	18,5X16,93X14,57	



**SUNRAY TOWABLE 1P**

ITEM NUMBER	EAN CODE	HS CODE	FEATURES
230119002	PCS. 8718181001335	95062900	420 DENIER NYLON COVER   24 GAUGE PVC MAX 1 PERSON TOWABLE ONE WAY BOSTON VALVE QUICK ROPE CONNECTOR 2 WEBBING HANDLES 4 HANDLES WITH NEOPRENE KNUCKLE GUARDS 2 WAY TOWABLE MULTI-POSITION TOWABLE NEOPRENE SEAT PADS DOUBLE-STITCHED NYLON DEFLATED SIZE : 64" X 60", 162 X 153CM 3 YEAR WARRANTY AFTER REGISTRATION
SIZE	MASTER CARTON INFO		
PCS.		QUANTITY PER M. CARTON: 3 M. CARTON WEIGHT (KG): 19,86 M. CARTON WEIGHT (LBS): 43,69 M. CARTON SIZE (M): 0,66 X 0,53 X 0,39 M. CARTON SIZE (INCH): 26 X 20,75 X 15,25	

**ANURA TOWABLE 1P**

<b>ITEM NUMBER</b>	<b>EAN CODE</b>	<b>HS CODE</b>	<b>FEATURES</b>
230116004	PCS. 8718181196871	95062900	420 DENIER NYLON COVER 26 GAUGE PVC MAX 1 PERSON TOWABLE ONE WAY BOSTON VALVE QUICK ROPE CONNECTOR
<b>SIZE</b>	<b>MASTER CARTON INFO</b>		
PCS.	<b>QUANTITY PER M. CARTON:</b>	3	2 HANDLES WITH NEOPRENE KNUCKLE GUARDS
	<b>M. CARTON WEIGHT (KG):</b>	20,64	USABLE AS LOUNGE CHAIR
	<b>M. CARTON WEIGHT (LBS):</b>	45,41	1 CUP HOLDER
	<b>M. CARTON SIZE (M):</b>	0,53 X 0,51 X 0,39	DOUBLE-STITCHED NYLON
	<b>M. CARTON SIZE (INCH):</b>	20,75 X 20 X 15,25	DEFLATED SIZE : 55" X 47", 140 X 120CM
			3 YEAR WARRANTY AFTER REGISTRATION



**REVOLVE TOWABLE 1P**

ITEM NUMBER	EAN CODE	HS CODE	FEATURES
230119001	PCS. 8718181001328	95062900	420 DENIER NYLON COVER 24 GAUGE PVC MAX 1 PERSONS TOWABLE ONE WAY BOSTON VALVE QUICK CONNECTOR
<b>SIZE</b>		<b>MASTER CARTON INFO</b>	
PCS.		QUANTITY PER M. CARTON: 3 M. CARTON WEIGHT (KG): 12,24 M. CARTON WEIGHT (LBS): 26,93 M. CARTON SIZE (M): 0,62X0,36X0,38 M. CARTON SIZE (INCH): 24,41X14,17X14,96	2 HANDLES WITH NEOPRENE KNUCKLE GUARDS NEOPRENE PADS DOUBLE-STITCHED NYLON DEFLATED SIZE : 51" X 70", 130 X 180CM 3 YEAR WARRANTY AFTER REGISTRATION



**WINGMAN TOWABLE 1P**

<b>ITEM NUMBER</b>	<b>EAN CODE</b>	<b>HS CODE</b>	<b>FEATURES</b>
230118004	PCS. 8718181000147	95062900	840 DENIER 28 GAUGE PVC MAX 1 PERSON TOWABLE ONE WAY BOSTON VALVE QUICK ROPE CONNECTOR NYLON COVER EQUIPPED WITH FINS: CONTROLABLE TUBE 4 HANDLES WITH NEOPRENE KNUCKLE GUARDS BIG NEOPRENE PAD DOUBLE STITCHED NYLON DEFLATED SIZE: 51.2 X 63" / 130 X 160CM
<b>SIZE</b>		<b>MASTER CARTON INFO</b>	
PCS.		QUANTITY PER M. CARTON: 1 M. CARTON WEIGHT (KG): 4,906 M. CARTON WEIGHT (LBS): 10,7952 M. CARTON SIZE (M): 0,45 X 0,27 X 0,5 M. CARTON SIZE (INCH): 11,72 X 10,63 X 19,69	



**DOUBLE TROUBLE TOWABLE 2P**

<b>ITEM NUMBER</b>	<b>EAN CODE</b>	<b>HS CODE</b>	<b>FEATURES</b>
230217004	PCS. 8718181209779	95062900	840 DENIER NYLON COVER 24 GAUGE PVC MAX 2 PERSONS TOWABLE ONE WAY BOSTON VALVE QUICK ROPE CONNECTOR
<b>SIZE</b>		<b>MASTER CARTON INFO</b>	
PCS.		QUANTITY PER M. CARTON: 3 M. CARTON WEIGHT (KG): 18,12 M. CARTON WEIGHT (LBS): 39,86 M. CARTON SIZE (M): 0,55X0,44X0,39 M. CARTON SIZE (INCH): 21,75X17,25X15,25	4 HANDLES WITH NEOPRENE KNUCKLE GUARDS SAFETY CHAMBER DOUBLE-STITCHED NYLON DEFLATED SIZE : 57" X 76", 145 X 193 CM 3 YEAR WARRANTY AFTER REGISTRATION



**TRIBAL II TOWABLE 2P**

ITEM NUMBER	EAN CODE	HS CODE	FEATURES
230218005	PCS. 8718181247771	95062900	840 DENIER NYLON COVER 28 GAUGE PVC MAX 2 PERSONS TOWABLE ONE WAY VALVE QUICK CONNECTOR 4 HANDLES WITH KNUCKLE PROTECTING NEOPRENE EASY ENTRY AIR FLOOR NEOPRENE SEAT PADS DOUBLE-STITCHED NYLON DEFLATED SIZE : 66" X 55", 168 X 140CM 3 YEAR WARRANTY AFTER REGISTRATION
<b>SIZE</b>		<b>MASTER CARTON INFO</b>	
PCS.		QUANTITY PER M. CARTON: 2 M. CARTON WEIGHT (KG): 15,14 M. CARTON WEIGHT (LBS): 33,31 M. CARTON SIZE (M): 0,52X0,33X0,42 M. CARTON SIZE (INCH): 20,47X12,99X16,54	

**STORM TOWABLE 2P**

<b>ITEM NUMBER</b>	<b>EAN CODE</b>	<b>HS CODE</b>	<b>FEATURES</b>
230217005	PCS. 8718181209755	95062900	420 DENIER NYLON COVER 24 GAUGE PVC MAX 2 PERSONS TOWABLE ONE WAY BOSTON VALVE QUICK ROPE CONNECTOR 6 HANDLES WITH NEOPRENE KNUCKLE GUARDS 2 NEOPRENE HANDLES NEOPRENE SEAT PADS DOUBLE-STITCHED NYLON DEFLATED SIZE : Ø 70", 178CM 3 YEAR WARRANTY AFTER REGISTRATION
<b>SIZE</b>		<b>MASTER CARTON INFO</b>	
PCS.		QUANTITY PER M. CARTON: 2 M. CARTON WEIGHT (KG): 15,02 M. CARTON WEIGHT (LBS): 33,04 M. CARTON SIZE (M): 0,52X0,33X0,45 M. CARTON SIZE (INCH): 20,47X12,99X1,72	



**CHASER TOWABLE 2P**

ITEM NUMBER	EAN CODE	HS CODE	FEATURES
230218003	PCS. 8718181247672	95062900	840 DENIER NYLON COVER 28 GAUGE PVC MAX 2 PERSONS TOWABLE ONE WAY BOSTON VALVE QUICK ROPE CONNECTOR 2 FOAM FILLED HANDLES NEOPRENE SEAT PADS DOUBLE-STITCHED NYLON DEFLATED SIZE : 100"   254CM 3 YEAR WARRANTY AFTER REGISTRATION
SIZE	MASTER CARTON INFO		
PCS.	QUANTITY PER M. CARTON:	2	
	M. CARTON WEIGHT (KG):	17,52	
	M. CARTON WEIGHT (LBS):	38,54	
	M. CARTON SIZE (M):	0,5 X 0,41 X 0,42	
	M. CARTON SIZE (INCH):	19,69 X 16,14 X 16,54	

**SCOUT TOWABLE 2P**

<b>ITEM NUMBER</b>	<b>EAN CODE</b>	<b>HS CODE</b>	<b>FEATURES</b>
230218004	PCS. 8718181247740	95062900	420 DENIER NYLON COVER 24 GAUGE PVC MAX 2 PERSONS TOWABLE ONE WAY BOSTON VALVE QUICK ROPE CONNECTOR
<b>SIZE</b>		<b>MASTER CARTON INFO</b>	
PCS.		QUANTITY PER M. CARTON: 3 M. CARTON WEIGHT (KG): 21,84 M. CARTON WEIGHT (LBS): 48,05 M. CARTON SIZE (M): 0,42X0,6X0,42 M. CARTON SIZE (INCH): 16,54X23,62X16,54	4 HANDLES WITH NEOPRENE KNUCKLE GUARDS 2 NEOPRENE HANDLES TAPERED SHAPE FOR EASY ENTRY NEOPRENE SEAT PADS DOUBLE-STITCHED NYLON DEFLATED SIZE : 61" X 70", 155 X 178CM 3 YEAR WARRANTY AFTER REGISTRATION



**KICK FLIP TOWABLE 2P**

ITEM NUMBER	EAN CODE	HS CODE	FEATURES
230217001	PCS. 8718181209731	95062900	840 DENIER NYLON COVER 28 GAUGE PVC MAX 2 PERSONS TOWABLE ONE WAY BOSTON VALVE QUICK ROPE CONNECTOR 8 HANDLES WITH NEOPRENE KNUCKLE GUARDS MULTI-POSITION TOWABLE 2 WAY TOWABLE NEOPRENE SEAT PADS DOUBLE-STITCHED NYLON DEFLATED SIZE : 62" X 50", 158 X 129CM 3 YEAR WARRANTY AFTER REGISTRATION
<b>SIZE</b>		<b>MASTER CARTON INFO</b>	
PCS.		QUANTITY PER M. CARTON: 2 M. CARTON WEIGHT (KG): 19,06 M. CARTON WEIGHT (LBS): 41,93 M. CARTON SIZE (M): 0,4X0,35X0,5 M. CARTON SIZE (INCH): 15,75X13,78X19,69	



**AIRSTREAM TOWABLE 2P**

<b>ITEM NUMBER</b>	<b>EAN CODE</b>	<b>HS CODE</b>	<b>FEATURES</b>
230218002	PCS. 8718181247634	95062900	840 DENIER NYLON COVER 28 GAUGE PVC MAX 2 PERSONS TOWABLE ONE WAY BOSTON VALVE QUICK ROPE CONNECTOR
<b>SIZE</b>		<b>MASTER CARTON INFO</b>	
PCS.		QUANTITY PER M. CARTON: 2 M. CARTON WEIGHT (KG): 16,22 M. CARTON WEIGHT (LBS): 35,68 M. CARTON SIZE (M): 0,45X0,42X0,43 M. CARTON SIZE (INCH): 11,72X16,54X16,95	4 HANDLES WITH NEOPRENE KNUCKLE GUARDS 2 WEBBING HANDLES NEOPRENE SEAT PADS DOUBLE-STITCHED NYLON DEFLATED SIZE : 66" X 44", 168 X 112CM 3 YEAR WARRANTY AFTER REGISTRATION



**ANURA TOWABLE 2P**

ITEM NUMBER	EAN CODE	HS CODE	FEATURES
230216001	PCS. 8718181178341	95062900	840 DENIER NYLON COVER 28 GAUGE PVC MAX 2 PERSONS TOWABLE ONE WAY BOSTON VALVE QUICK ROPE CONNECTOR 4 HANDLES WITH NEOPRENE KNUCKLE GUARDS USABLE AS LOUNGE CHAIR 2 CUP HOLDERS DOUBLE-STITCHED NYLON DEFLATED SIZE : 55" X 47", 165 X 160CM 3 YEAR WARRANTY AFTER REGISTRATION
SIZE	MASTER CARTON INFO		
PCS.	QUANTITY PER M. CARTON:	2	
	M. CARTON WEIGHT (KG):	22,4	
	M. CARTON WEIGHT (LBS):	49,28	
	M. CARTON SIZE (M):	0,55 X 0,41 X 0,45	
	M. CARTON SIZE (INCH):	21,75 X 16 X 17,72	

**REVOLVE TOWABLE 2P**

<b>ITEM NUMBER</b>	<b>EAN CODE</b>	<b>HS CODE</b>	<b>FEATURES</b>
230219001	PCS. 8718181001359	95062900	420 DENIER NYLON COVER 24 GAUGE PVC MAX 2 PERSONS TOWABLE ONE WAY BOSTON VALVE QUICK CONNECTOR 4 HANDLES WITH NEOPRENE KNUCKLE GUARDS NEOPRENE PADS DOUBLE-STITCHED NYLON DEFLATED SIZE : 70" X 70", 180 X 180CM 3 YEAR WARRANTY AFTER REGISTRATION
<b>SIZE</b>		<b>MASTER CARTON INFO</b>	
PCS.		QUANTITY PER M. CARTON: 2 M. CARTON WEIGHT (KG): 8,16 M. CARTON WEIGHT (LBS): 17,95 M. CARTON SIZE (M): 0,43X0,42X0,43 M. CARTON SIZE (INCH): 16,93X16,54X16,93	



**BINAR TOWABLE 2P**

ITEM NUMBER	EAN CODE	HS CODE	FEATURES
230218001	PCS. 8718181247665	95062900	840 DENIER NYLON COVER   28 GAUGE PVC MAX 2 PERSONS TOWABLE ONE WAY BOSTON VALVE QUICK CONNECTOR 7 HANDLES WITH NEOPRENE KNUCKLE GUARDS 2 NEOPRENE HANDLES MULTI-POSITION TOWABLE 2 WAY TOWABLE NEOPRENE SEAT PADS DOUBLE-STITCHED NYLON DEFLATED SIZE : 81" X 78", 206 X 198CM 3 YEAR WARRANTY AFTER REGISTRATION
SIZE	MASTER CARTON INFO		
PCS.		QUANTITY PER M. CARTON: 1 M. CARTON WEIGHT (KG): 15,53 M. CARTON WEIGHT (LBS): 34,17 M. CARTON SIZE (M): 0,47 X 0,42 X 0,27 M. CARTON SIZE (INCH): 18,5 X 16,54 X 10,63	



**3 YEARS  
WARRANTY**



**GIANT TOWABLE 3P**

<b>ITEM NUMBER</b>	<b>EAN CODE</b>	<b>HS CODE</b>	<b>FEATURES</b>
230317001	PCS. 8718181209793	95062900	840 DENIER NYLON COVER 28 GAUGE PVC MAX 3 PERSONS TOWABLE ONE WAY BOSTON VALVE QUICK ROPE CONNECTOR 6 HANDLES WITH NEOPRENE KNUCKLE GUARDS SAFETY CHAMBER DOUBLE-STITCHED NYLON DEFLATED SIZE : Ø71", 181 CM 3 YEAR WARRANTY AFTER REGISTRATION
<b>SIZE</b>		<b>MASTER CARTON INFO</b>	
PCS.		QUANTITY PER M. CARTON: 2 M. CARTON WEIGHT (KG): 14,7 M. CARTON WEIGHT (LBS): 32,34 M. CARTON SIZE (M): 0,47X0,34X0,47 M. CARTON SIZE (INCH): 18,5X13,39X18,5	

**TRIPLET TOWABLE 3P**

ITEM NUMBER	EAN CODE	HS CODE	FEATURES
230317004	PCS. 8718181209830	95062900	840 DENIER NYLON COVER 26 GAUGE PVC MAX 3 PERSONS TOWABLE ONE WAY BOSTON VALVE QUICK ROPE CONNECTOR SAFETY CHAMBER DOUBLE-STITCHED NYLON DEFLATED SIZE : 57" X 94.5", 145 X 240 CM 3 YEAR WARRANTY AFTER REGISTRATION
SIZE	MASTER CARTON INFO		
PCS.	QUANTITY PER M. CARTON:	2	
	M. CARTON WEIGHT (KG):	19,36	
	M. CARTON WEIGHT (LBS):	42,59	
	M. CARTON SIZE (M):	0,54X0,4X0,47	
	M. CARTON SIZE (INCH):	21,25X15,75X18,5	



**CHASER TOWABLE 3P**

ITEM NUMBER	EAN CODE	HS CODE	FEATURES
230318001	PCS. 8718181247689	95062900	840 DENIER NYLON COVER 28 GAUGE PVC MAX 3 PERSONS TOWABLE ONE WAY BOSTON VALVE QUICK ROPE CONNECTOR 3 FOAM FILLED HANDLES NEOPRENE SEAT PADS DOUBLE-STITCHED NYLON DEFLATED SIZE : 119"   302CM 3 YEAR WARRANTY AFTER REGISTRATION
SIZE	MASTER CARTON INFO		
PCS.	QUANTITY PER M. CARTON:	1	
	M. CARTON WEIGHT (KG):	11,26	
	M. CARTON WEIGHT (LBS):	24,77	
	M. CARTON SIZE (M):	0,57X0,46X0,22	
	M. CARTON SIZE (INCH):	22,44X18,11X8,66	



**TORNADO TOWABLE 3P**

<b>ITEM NUMBER</b>	<b>EAN CODE</b>	<b>HS CODE</b>	<b>FEATURES</b>
230317005	PCS. 8718181209816	95062900	840 DENIER NYLON COVER 28 GAUGE PVC MAX 3 PERSONS TOWABLE ONE WAY BOSTON VALVE QUICK ROPE CONNECTOR 6 HANDLES WITH NEOPRENE KNUCKLE GUARDS 4 NEOPRENE HANDLES NEOPRENE SEAT PADS DOUBLE-STITCHED NYLON DEFLATED SIZE :Ø 80", 203CM 3 YEAR WARRANTY AFTER REGISTRATION
<b>SIZE</b>		<b>MASTER CARTON INFO</b>	
PCS.		QUANTITY PER M. CARTON: 2 M. CARTON WEIGHT (KG): 22,34 M. CARTON WEIGHT (LBS): 49,15 M. CARTON SIZE (M): 0,52X0,38X0,45 M. CARTON SIZE (INCH): 20,47X14,96X17,72	



**SCOUT TOWABLE 3P**

<i>ITEM NUMBER</i>	<i>EAN CODE</i>	<i>HS CODE</i>	<i>FEATURES</i>
230318004	PCS. 8718181247757	95062900	420 DENIER NYLON COVER 24 GAUGE PVC MAX 3 PERSONS TOWABLE ONE WAY BOSTON VALVE QUICK ROPE CONNECTOR 6 HANDLES WITH NEOPRENE KNUCKLE GUARDS 2 NEOPRENE HANDLES TAPERED SHAPE FOR EASY ENTRY NEOPRENE SEAT PADS DOUBLE-STITCHED NYLON DEFLATED SIZE : 70" X 76", 178 X 193CM 3 YEAR WARRANTY AFTER REGISTRATION
<i>SIZE</i>	<i>MASTER CARTON INFO</i>		
PCS.	QUANTITY PER M. CARTON: 2 M. CARTON WEIGHT (KG): 20,08 M. CARTON WEIGHT (LBS): 44,18 M. CARTON SIZE (M): 0,45X0,43X0,42 M. CARTON SIZE (INCH): 17,72X16,93X16,54		

**TRIBAL TOWABLE 3P**

<b>ITEM NUMBER</b>	<b>EAN CODE</b>	<b>HS CODE</b>	<b>FEATURES</b>
230319003	PCS. 8718181001397	95062900	840 DENIER NYLON COVER 28 GAUGE PVC MAX 3 PERSONS TOWABLE ONE WAY BOSTON VALVE QUICK ROPE CONNECTOR 8 HANDLES WITH NEOPRENE KNUCKLE GUARDS EASY TO ENTER AIR FLOOR DOUBLE-STITCHED NYLON DEFLATED SIZE: 59" X 78,7"   150 X 200 CM 3 YEAR WARRANTY AFTER REGISTRATION
<b>SIZE</b>		<b>MASTER CARTON INFO</b>	
PCS.		QUANTITY PER M. CARTON: 2 M. CARTON WEIGHT (KG): 41,76 M. CARTON WEIGHT (LBS): 91,87 M. CARTON SIZE (M): 0,43X0,42X0,43 M. CARTON SIZE (INCH): 16,93X16,54X16,93	



**AIRSTREAM TOWABLE 3P**

ITEM NUMBER	EAN CODE	HS CODE	FEATURES
230318002	PCS. 8718181247641	95062900	840 DENIER NYLON COVER 30 GAUGE PVC MAX 3 PERSONS TOWABLE ONE WAY BOSTON VALVE QUICK ROPE CONNECTOR 6 HANDLES WITH NEOPRENE KNUCKLE GUARDS 2 WEBBING HANDLES NEOPRENE SEAT PADS DOUBLE-STITCHED NYLON DEFLATED SIZE : 76" X 60", 193 X 153CM 3 YEAR WARRANTY AFTER REGISTRATION
SIZE	MASTER CARTON INFO		
PCS.	QUANTITY PER M. CARTON:	1	
	M. CARTON WEIGHT (KG):	14,83	
	M. CARTON WEIGHT (LBS):	32,63	
	M. CARTON SIZE (M):	0,45 X 0,42 X 0,24	
	M. CARTON SIZE (INCH):	11,72 X 16,54 X 9,45	



### ANURA TOWABLE 3P

ITEM NUMBER	EAN CODE	HS CODE	FEATURES
230316001	PCS. 8718181178372	95062900	840 DENIER NYLON COVER 30 GAUGE PVC MAX 3 PERSONS TOWABLE ONE WAY BOSTON VALVE QUICK ROPE CONNECTOR 6 HANDLES WITH NEOPRENE KNUCKLE GUARDS USABLE AS LOUNGE CHAIR 2 CUP HOLDERS DOUBLE-STITCHED NYLON DEFLATED SIZE : 71" X 79", 180 X 200CM 3 YEAR WARRANTY AFTER REGISTRATION
SIZE	MASTER CARTON INFO		
PCS.	QUANTITY PER M. CARTON:	1	
	M. CARTON WEIGHT (KG):	16,84	
	M. CARTON WEIGHT (LBS):	37,05	
	M. CARTON SIZE (M):	0,5X0,23X0,76	
	M. CARTON SIZE (INCH):	19,75X9X29,75	



**REVOLVE TOWABLE 3P**

ITEM NUMBER	EAN CODE	HS CODE	FEATURES
230319001	PCS. 8718181001373	95062900	840 DENIER NYLON COVER 28 GAUGE PVC MAX 3 PERSONS TOWABLE ONE WAY BOSTON VALVE QUICK CONNECTOR 6 HANDLES WITH NEOPRENE KNUCKLE GUARDS NEOPRENE PADS DOUBLE-STITCHED NYLON DEFLATED SIZE : 70" X 90", 180 X 230CM 3 YEAR WARRANTY AFTER REGISTRATION
SIZE	MASTER CARTON INFO		
PCS.	QUANTITY PER M. CARTON:	2	
	M. CARTON WEIGHT (KG):	41,76	
	M. CARTON WEIGHT (LBS):	91,87	
	M. CARTON SIZE (M):	0,52X0,45X0,42	
	M. CARTON SIZE (INCH):	20,47X1,72X16,54	



### LUNAR TOWABLE 3P

ITEM NUMBER	EAN CODE	HS CODE	FEATURES
230318003	PCS. 8718181247733	95062900	840 DENIER NYLON COVER   28 GAUGE PVC MAX 3 PERSONS TOWABLE ONE WAY BOSTON VALVE QUICK ROPE CONNECTOR 10 HANDLES WITH NEOPRENE KNUCKLE GUARDS 2 NEOPRENE HANDLES MULTI-POSITION TOWABLE 2 WAY TOWABLE NEOPRENE SEAT PADS DOUBLE-STITCHED NYLON DEFLATED SIZE : 100" X 78", 254 X 198CM 3 YEAR WARRANTY AFTER REGISTRATION
SIZE	MASTER CARTON INFO		
PCS.		QUANTITY PER M. CARTON: 1 M. CARTON WEIGHT (KG): 20,88 M. CARTON WEIGHT (LBS): 45,94 M. CARTON SIZE (M): 0,53 X 0,47 X 0,28 M. CARTON SIZE (INCH): 20,87 X 18,5 X 11,02	



**SEA-ESTA TOWABLE 3P**

ITEM NUMBER	EAN CODE	HS CODE	FEATURES
230318005	PCS. 8718181247788	95062900	840 DENIER NYLON COVER   28 GAUGE PVC MAX 3 PERSONS TOWABLE ONE WAY BOSTON VALVE 12 HANDLES WITH NEOPRENE KNUCKLE GUARDS MULTI-POSITION TOWABLE   MULTI-FUNCTIONAL TOWABLE FOLDABLE SUNROOF 4 CUP HOLDERS INFLATABLE BACKREST NEOPRENE SEAT PAD DOUBLE-STITCHED NYLON DEFLATED SIZE : 112" X 98", 285 X 250 CM 3 YEAR WARRANTY AFTER REGISTRATION
SIZE	MASTER CARTON INFO		
PCS.	QUANTITY PER M. CARTON:	1	
	M. CARTON WEIGHT (KG):	28,91	
	M. CARTON WEIGHT (LBS):	63,6	
	M. CARTON SIZE (M):	0,46 X 0,27 X 0,75	
	M. CARTON SIZE (INCH):	18,11 X 10,63 X 29,53	



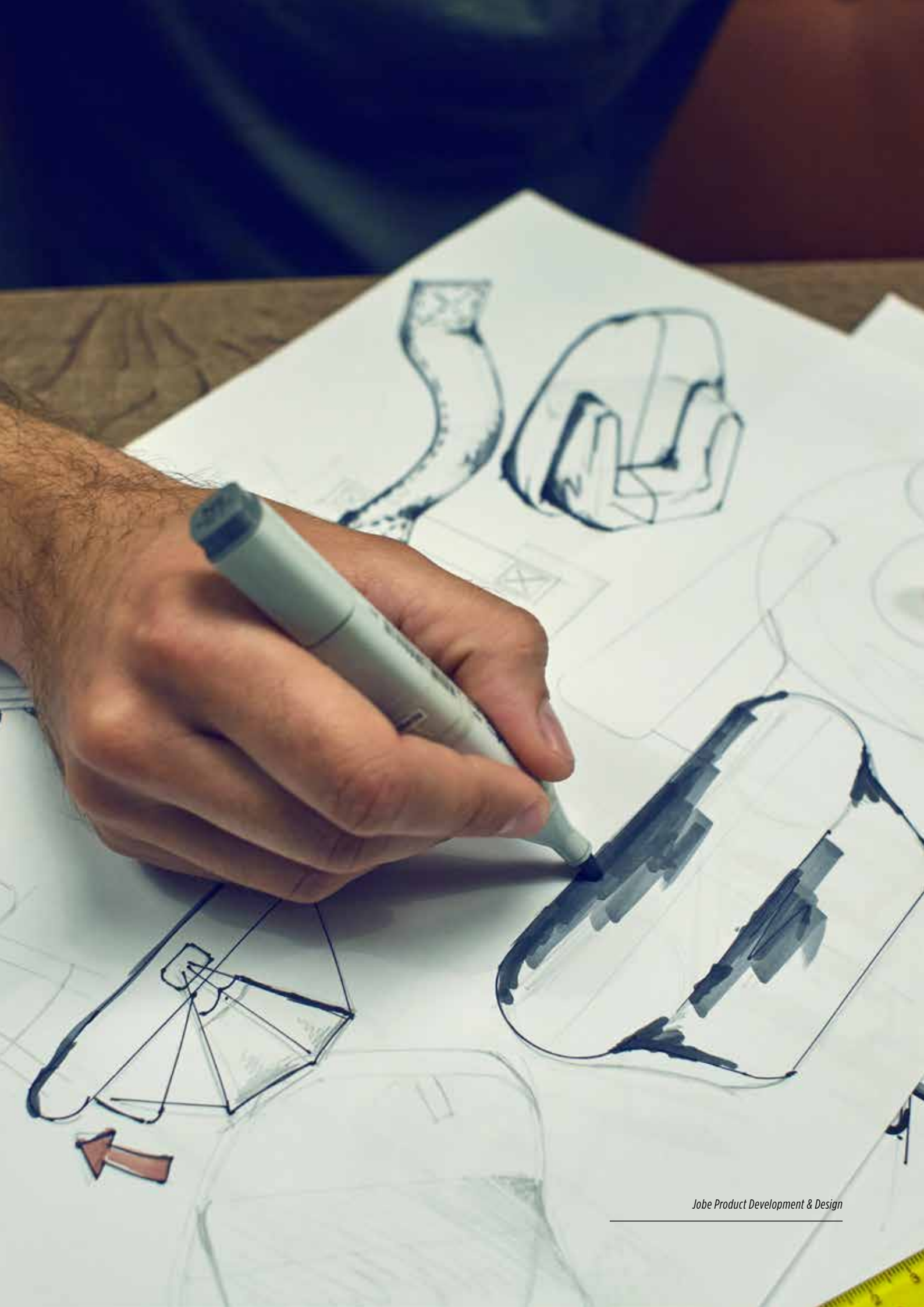



**CHASER TOWABLE 4P**

ITEM NUMBER	EAN CODE	HS CODE	FEATURES
230418001	PCS. 8718181247696	95062900	840 DENIER NYLON COVER 28 GAUGE PVC MAX 4 PERSONS TOWABLE ONE WAY BOSTON VALVE QUICK ROPE CONNECTOR 4 FOAM FILLED HANDLES NEOPRENE SEAT PADS DOUBLE-STITCHED NYLON DEFLATED SIZE : 135"   343CM 3 YEAR WARRANTY AFTER REGISTRATION
SIZE	MASTER CARTON INFO		
PCS.	QUANTITY PER M. CARTON:	1	
	M. CARTON WEIGHT (KG):	13,2	
	M. CARTON WEIGHT (LBS):	29,04	
	M. CARTON SIZE (M):	0,57X0,46X0,24	
	M. CARTON SIZE (INCH):	22,44X18,11X9,45	

**AIRSTREAM TOWABLE 4P**

<b>ITEM NUMBER</b>	<b>EAN CODE</b>	<b>HS CODE</b>	<b>FEATURES</b>
230418003	PCS. 8718181247658	95062900	840 DENIER NYLON COVER 30 GAUGE PVC MAX 4 PERSONS TOWABLE ONE WAY VALVE QUICK CONNECTOR 8 HANDLES WITH NEOPRENE KNUCKLE GUARDS 2 WEBBING HANDLES NEOPRENE SEAT PADS DOUBLE-STITCHED NYLON DEFLATED SIZE : 85" X 75", 193 X 153CM 3 YEAR WARRANTY AFTER REGISTRATION
<b>SIZE</b>		<b>MASTER CARTON INFO</b>	
PCS.		QUANTITY PER M. CARTON: 1 M. CARTON WEIGHT (KG): 20 M. CARTON WEIGHT (LBS): 44 M. CARTON SIZE (M): 0,55X0,47X0,29 M. CARTON SIZE (INCH): 21,65X18,5X11,42	



**SONAR TOWABLE 4P**

ITEM NUMBER	EAN CODE	HS CODE	FEATURES
230418002	PCS. 8718181247764	95062900	840 DENIER NYLON COVER   30 GAUGE PVC MAX 4 PERSONS TOWABLE ONE WAY BOSTON VALVE QUICK ROPE CONNECTOR 13 HANDLES WITH NEOPRENE KNUCKLE GUARDS 2 NEOPRENE HANDLES MULTI-POSITION TOWABLE 2 WAY TOWABLE NEOPRENE SEAT PADS DOUBLE-STITCHED NYLON DEFLATED SIZE : 120" X 78", 305 X 198CM 3 YEAR WARRANTY AFTER REGISTRATION
SIZE	MASTER CARTON INFO		
PCS.	QUANTITY PER M. CARTON: 1 M. CARTON WEIGHT (KG): 26,97 M. CARTON WEIGHT (LBS): 59,33 M. CARTON SIZE (M): 0,6 X 0,51 X 0,28 M. CARTON SIZE (INCH): 23,62 X 20,08 X 11,02		





## FOOT PUMP

ITEM NUMBER	EAN CODE	HS CODE	FEATURES
410017101	PCS. 8718181208703	84142080	CAPACITY: 2000 CM <sup>3</sup> HALKEY ROBERTS NOZZLE FOR INFLATABLE BOATS. 4 DIFFERENT NOZZLES TO FIT MOST VALVES
SIZE	MASTER CARTON INFO		
PCS.	QUANTITY PER M. CARTON:	6	
	M. CARTON WEIGHT (KG):	4,92	
	M. CARTON WEIGHT (LBS):	10,824	
	M. CARTON SIZE (M):	0,48X0,34X0,23	
	M. CARTON SIZE (INCH):	19 X 13,5 X 9	



## HAND PUMP DOUBLE ACTION

ITEM NUMBER	EAN CODE	HS CODE	FEATURES
410017102	PCS. 8718181208628	84142080	PLASTIC 19" PUMP PRESSURE: UP TO 1 BAR (14,5PSI). CAPACITY: 2X2000 CM3. ACCORDION STYLE HOSE 5 DIFFERENT NOZZLES TO FIT MOST VALVES
<b>SIZE</b>		<b>MASTER CARTON INFO</b>	
PCS.		QUANTITY PER M. CARTON: 3 M. CARTON WEIGHT (KG): 2,97 M. CARTON WEIGHT (LBS): 6,534 M. CARTON SIZE (M): 0,49X0,24X0,36 M. CARTON SIZE (INCH): 19,37X9,37X14,25	



**AIR PUMP 12V**

ITEM NUMBER	EAN CODE	HS CODE	FEATURES
410019003	PCS. 8718181007238	84148080	DIMENSIONS: 12X11.5X12.5 CM 12V PUMP 3 DIFFERENT NOZZLES CIGARETTE LIGHTER CONNECTOR
SIZE	MASTER CARTON INFO		
PCS.	QUANTITY PER M. CARTON:	6	
	M. CARTON WEIGHT (KG):	3,84	
	M. CARTON WEIGHT (LBS):	8,448	
	M. CARTON SIZE (M):	0,36X0,17X0,28	
	M. CARTON SIZE (INCH):	14X6,5X11	





**AIR PUMP WITH UK PLUG 230V**

ITEM NUMBER	EAN CODE	HS CODE	FEATURES
410019002	PCS. 8718181007221	84148080	DIMENSIONS: 12X11.5X12.5 CM 230V AIR PUMP UK PLUG 3 DIFFERENT NOZZLES INFLATES AND DEFLATES
SIZE	MASTER CARTON INFO		
PCS.	QUANTITY PER M. CARTON:	6	
	M. CARTON WEIGHT (KG):	5,28	
	M. CARTON WEIGHT (LBS):	11,616	
	M. CARTON SIZE (M):	0,36X0,17X0,28	
	M. CARTON SIZE (INCH):	14X6,5X11	



**AIR PUMP 230V**

ITEM NUMBER	EAN CODE	HS CODE	FEATURES
410019001	PCS. 8718181007214	84148080	DIMENSIONS: 12X11.5X12.5 CM 230V AIR PUMP 3 DIFFERENT NOZZLES INFLATES AND DEFLATES
SIZE	MASTER CARTON INFO		
PCS.	QUANTITY PER M. CARTON:	6	
	M. CARTON WEIGHT (KG):	4,74	
	M. CARTON WEIGHT (LBS):	10,428	
	M. CARTON SIZE (M):	0,36X0,17X0,28	
	M. CARTON SIZE (INCH):	14X6,5X11	

**TURBO PUMP 12V**

<b>ITEM NUMBER</b>	<b>EAN CODE</b>	<b>HS CODE</b>	<b>FEATURES</b>
410017201	PCS. 8718181208581	84148080	DIMENSIONS: 16X12.5X12.5 CM 12V PUMP 4 DIFFERENT NOZZLES INCLUDING HALKEY ROBERTS NOZZLE CRUSH RESISTANT HOSE UP TO 2.5 PSI/0.17 BAR
<b>SIZE</b>		<b>MASTER CARTON INFO</b>	
PCS.		QUANTITY PER M. CARTON: 4 M. CARTON WEIGHT (KG): 4,8 M. CARTON WEIGHT (LBS): 10,56 M. CARTON SIZE (M): 0,4X0,36X0,18 M. CARTON SIZE (INCH): 15,75X14X7	



**HEAVY DUTY PUMP**

ITEM NUMBER	EAN CODE	HS CODE	FEATURES
410017301	PCS. 8718181208604	84148080	DIMENSIONS: 21.5X18X16 CM STRONG 230V PUMP INCLUDES A HALKEY ROBERTS NOZZLE INFLATES AND DEFLATES
<b>SIZE</b>	<b>MASTER CARTON INFO</b>		
PCS.	QUANTITY PER M. CARTON: 2		
	M. CARTON WEIGHT (KG): 5,26		
	M. CARTON WEIGHT (LBS): 11,572		
	M. CARTON SIZE (M): 0,58X0,32X0,22		
	M. CARTON SIZE (INCH): 23X12,5X8,5		



**MAGNUM BRIDLE 8FT 4P**

ITEM NUMBER	EAN CODE	HS CODE	FEATURES
410102005	PCS. 8718181023849	95062900	MAXIMUM PULL 4 PERSON TOWABLES. TOTAL LENGTH 8FT./2.43 M 2 STAINLESS STEEL HOOKS TO CONNECT WITH YOUR BOAT. FLOAT TO KEEP THE ROPE AWAY FROM PROPELLOR
<b>SIZE</b>	<b>MASTER CARTON INFO</b>		
PCS.	QUANTITY PER M. CARTON: 12 M. CARTON WEIGHT (KG): 6,6 M. CARTON WEIGHT (LBS): 14,52 M. CARTON SIZE (M): 0,34X0,23X0,32 M. CARTON SIZE (INCH): 13,39X9,06X12,6		



**BUCKLE CONNECTOR**

ITEM NUMBER	EAN CODE	HS CODE	FEATURES
230812001	PCS. 8718181089296	95062900	FITS ALL TOWABLES WITHOUT A BUCKLE 3 FT UNIVERSAL CONNECTOR
SIZE	MASTER CARTON INFO		
PCS.	QUANTITY PER M. CARTON: 50	M. CARTON WEIGHT (KG): 14,5	M. CARTON WEIGHT (LBS): 31,9
	M. CARTON SIZE (M): 0,47X0,32X0,53	M. CARTON SIZE (INCH): 18,5X12,6X20,87	





**TOWROPE 2P**

ITEM NUMBER	EAN CODE	HS CODE	FEATURES
211917018	PCS. 8718181208789	56090000	MAXIMUM PULL 2 PERSONS LENGTH 50FT./15.24 M 1 SECTION STAINLESS STEEL HOOK CONNECTION. FLOAT TO KEEP THE ROPE AWAY FROM PROPELLOR BREAK STRENGTH ROPES: 2375LBS (1077KG) TOWABLE ROPE
<b>SIZE</b>	<b>MASTER CARTON INFO</b>		
PCS.	QUANTITY PER M. CARTON: 12 M. CARTON WEIGHT (KG): 6,6 M. CARTON WEIGHT (LBS): 14,52 M. CARTON SIZE (M): 0,51X0,27 X0,34 M. CARTON SIZE (INCH): 20,08X10,43X13,39		





**TOWROPE 4P**

ITEM NUMBER	EAN CODE	HS CODE	FEATURES
211917019	PCS. 8718181208802	56090000	MAXIMUM PULL 4 PERSONS LENGTH 55FT./16.76 M 1 SECTION FLOAT TO KEEP THE ROPE AWAY FROM PROPELLOR BREAK STRENGTH ROPES: 4150LBS (1882KG). TOWABLE ROPE
<b>SIZE</b>	<b>MASTER CARTON INFO</b>		
PCS.	QUANTITY PER M. CARTON: 12	M. CARTON WEIGHT (KG): 13,2	
	M. CARTON WEIGHT (LBS): 29,04	M. CARTON SIZE (M): 0,52X0,3X0,53	
	M. CARTON SIZE (INCH): 20,47X11,81X20,87		



**TOWROPE 6P**

ITEM NUMBER	EAN CODE	HS CODE	FEATURES
211917020	PCS. 8718181208918	56090000	MAXIMUM PULL 6 PERSONS LENGTH 55FT./16.76 M 1 SECTION FLOAT TO KEEP THE ROPE AWAY FROM PROPELLOR BREAK STRENGTH ROPES: 6100LBS (2767KG). TOWABLE ROPE
SIZE	MASTER CARTON INFO		
PCS.	QUANTITY PER M. CARTON: 10	M. CARTON WEIGHT (KG): 12,2	
	M. CARTON WEIGHT (LBS): 26,84	M. CARTON SIZE (M): 0,57X0,32X0,48	
	M. CARTON SIZE (INCH): 22,44X12,6X18,9		



**TOWROPE 10P**

ITEM NUMBER	EAN CODE	HS CODE	FEATURES
211917021	PCS. 8718181208970	56090000	MAXIMUM PULL 10 PERSONS LENGTH 63FT./19.20 M 1 SECTION FLOAT TO KEEP THE ROPE AWAY FROM PROPELLOR BREAK STRENGTH ROPES: 6100LBS (2767KG). TOWABLE ROPE
<b>SIZE</b>	<b>MASTER CARTON INFO</b>		
PCS.	QUANTITY PER M. CARTON: 6		
	M. CARTON WEIGHT (KG): 11,7		
	M. CARTON WEIGHT (LBS): 25,74		
	M. CARTON SIZE (M): 0,62X0,32X0,35		
	M. CARTON SIZE (INCH): 24,21X12,4X13,78		



**BUNGEE EXTENSION**

ITEM NUMBER	EAN CODE	HS CODE	FEATURES
211917022	PCS. 8718181209076	56090000	MAXIMUM PULL 4 PERSONS LENGTH 3FT/91.44 CM MAX BREAK STRENGTH 4100LBS -1860KG
<b>SIZE</b>	<b>MASTER CARTON INFO</b>		1 SECTION CREATES A TOTALLY NEW DIMENSION TO TOWABLE-RIDING REDUCES THE STRESS ON THE TOW POINT TOWABLE EXTENSION ROPE
PCS.	QUANTITY PER M. CARTON: 20 M. CARTON WEIGHT (KG): 7,8 M. CARTON WEIGHT (LBS): 17,16 M. CARTON SIZE (M): 0,51X0,3X0,32 M. CARTON SIZE (INCH): 19,88 X11,61 X12,6		



**BUNGEE ROPE**

ITEM NUMBER	EAN CODE	HS CODE	FEATURES
211917023	PCS. 8718181209090	56090000	MAXIMUM PULL 4 PERSONS LENGTH 49FT/14.93 M CARRY UP TO 3235LBS (1467KG). 1 SECTION. CREATES A TOTALLY NEW DIMENSION TO TOWABLE-RIDING REDUCES THE STRESS ON THE TOW POINT ITS ELASTIC FEELING PROVIDES MORE FUN TOWABLE ROPE
SIZE	MASTER CARTON INFO		
PCS.	QUANTITY PER M. CARTON: 8	M. CARTON WEIGHT (KG): 13,12	
	M. CARTON WEIGHT (LBS): 28,864	M. CARTON SIZE (M): 0,55X0,3X0,4	
	M. CARTON SIZE (INCH): 21,65X11,81X15,75		



**QUICK RELEASE WITH WRIST SEAL**

ITEM NUMBER	EAN CODE	HS CODE	FEATURES
210017033	PCS. 8718181208888	95062900	STAINLESS STEEL RELEASE SYSTEM COMFORTABLE WRIST SEAL
SIZE		MASTER CARTON INFO	
PCS.		QUANTITY PER M. CARTON: 100 M. CARTON WEIGHT (KG): 23 M. CARTON WEIGHT (LBS): 50,6 M. CARTON SIZE (M): 0,32X0,32X0,53 M. CARTON SIZE (INCH): 12,6X12,6X20,87	

**TUBE BAG 1-2P**

<b>ITEM NUMBER</b>	<b>EAN CODE</b>	<b>HS CODE</b>	<b>FEATURES</b>
220816001	PCS. 8718181180450	42029291	SUITABLE FOR 1-2 PERSON TOWABLES. EASY AND CLEAN STORAGE
<b>SIZE</b>	<b>MASTER CARTON INFO</b>		
PCS.	QUANTITY PER M. CARTON: 50 M. CARTON WEIGHT (KG): 11 M. CARTON WEIGHT (LBS): 24,2 M. CARTON SIZE (M): 0,64X0,35X0,26 M. CARTON SIZE (INCH): 25,2X13,78X10,24		



**TUBE BAG 3-5P**

ITEM NUMBER	EAN CODE	HS CODE	FEATURES
220816002	PCS. 8718181180474	42029291	SUITABLE FOR 3-5 PERSON TOWABLES. EASY AND CLEAN STORAGE
SIZE	MASTER CARTON INFO		
PCS.	QUANTITY PER M. CARTON: 25	M. CARTON WEIGHT (KG): 11	M. CARTON WEIGHT (LBS): 24,2
	M. CARTON SIZE (M): 0,64 X 0,28 X 0,3	M. CARTON SIZE (INCH): 25,2 X 11,02 X 11,81	



**TOWABLE REPAIR KIT**

▶ 41001001

**MULTI PURPOSE REPAIR KIT**

▶ 42000501

**BOSTON VALVE**

▶ 410800024

**COMPRESSOR ADAPTOR**

▶ 410200023



**WATERSLED 3P**

ITEM NUMBER	EAN CODE	HS CODE	FEATURES
320312001	PCS. 8718181122511	95062900	THICKEST PVC IN THE INDUSTRY HALKEY ROBERTS VALVE THERMO BONDED SEAMS REPAIR KIT AND PUMP INCLUDED DEFLATED SIZE - 134"   340CM
SIZE	MASTER CARTON INFO		
PCS.	QUANTITY PER M. CARTON: 1	M. CARTON WEIGHT (KG): 14,73	M. CARTON WEIGHT (LBS): 32,406
	M. CARTON SIZE (M): 0,6X0,49X0,24	M. CARTON SIZE (INCH): 23,62X19,29X9,45	



**WATERSLED 5P**

ITEM NUMBER	EAN CODE	HS CODE	FEATURES
320512001	PCS. 8718181122535	95062900	THICKEST PVC IN THE INDUSTRY HALKEY ROBERTS VALVE THERMO BONDED SEAMS REPAIR KIT AND PUMP INCLUDED DEFLATED SIZE - 201"   510CM
<b>SIZE</b>	<b>MASTER CARTON INFO</b>		
PCS.	QUANTITY PER M. CARTON: 1 M. CARTON WEIGHT (KG): 24,44 M. CARTON WEIGHT (LBS): 53,768 M. CARTON SIZE (M): 0,83X0,53X0,24 M. CARTON SIZE (INCH): 32,68X20,87X9,45		



**WATERSLED 6P**

ITEM NUMBER	EAN CODE	HS CODE	FEATURES
320612001	PCS. 8718181122542	95062900	THICKEST PVC IN THE INDUSTRY HALKEY ROBERTS VALVE THERMO BONDED SEAMS REPAIR KIT AND PUMP INCLUDED DEFLATED SIZE - 220,5"   560CM
<b>SIZE</b>		<b>MASTER CARTON INFO</b>	
PCS.		QUANTITY PER M. CARTON: 1 M. CARTON WEIGHT (KG): 27,11 M. CARTON WEIGHT (LBS): 59,642 M. CARTON SIZE (M): 0,86X0,53X0,25 M. CARTON SIZE (INCH): 33,86X20,87X9,84	



**WATERSLED 8P**

ITEM NUMBER	EAN CODE	HS CODE	FEATURES
320812001	PCS. 8718181122559	95062900	THICKEST PVC IN THE INDUSTRY HALKEY ROBERTS VALVE THERMO BONDED SEAMS REPAIR KIT AND PUMP INCLUDED DEFLATED SIZE - 248"   630CM
<b>SIZE</b>	<b>MASTER CARTON INFO</b>		
PCS.	QUANTITY PER M. CARTON: 1 M. CARTON WEIGHT (KG): 30,98 M. CARTON WEIGHT (LBS): 68,156 M. CARTON SIZE (M): 0,91X0,55X0,25 M. CARTON SIZE (INCH): 35,83X21,65X9,84		



**MULTI RIDER REPAIR KIT**

ITEM NUMBER	EAN CODE	HS CODE	FEATURES
320005002	PCS. 8718181017640	35061000	REPAIRS ALL MULTI-RIDERS INCLUDING 1 TUBE OF GLUE AND 1 PVC PATCH
<b>SIZE</b>	<b>MASTER CARTON INFO</b>		
PCS.	QUANTITY PER M. CARTON: 80 M. CARTON WEIGHT (KG): 17,6 M. CARTON WEIGHT (LBS): 38,72 M. CARTON SIZE (M): 1,35X0,4X0,24 M. CARTON SIZE (INCH): 53,15X15,75X9,45		



**LEISURE MUSTHAVES**



**WATER CARPET**

ITEM NUMBER	EAN CODE	HS CODE	FEATURES
280018001	PCS. 8718181263610	95062900	3 SOFT LAYERS OF FOAM DENSITY: FIRM/SOFT/FIRM SIZE 12' X 6'
<b>SIZE</b>		<b>MASTER CARTON INFO</b>	4 ANCHOR POINTS FOR MOORING OPTIONS (NOT INTENDED TO BE USED AS A TOW POINT)
PCS.		QUANTITY PER M. CARTON: 1	2 WEBBING STRAPS.
		M. CARTON WEIGHT (KG): 2,2	6 KIDS - 4 ADULTS.
		M. CARTON WEIGHT (LBS): 4,84	EASY TO STORE ON YOUR BOAT
		M. CARTON SIZE (M): 1,83X0,48X0,48	MULTIPLE FUNCTIONS
		M. CARTON SIZE (INCH): 72,05X18,9X18,9	





**DIPPER BODYBOARD**

ITEM NUMBER	EAN CODE	HS CODE	FEATURES
286219001	36 INCH 8718181003780 39 INCH 8718181003797 42 INCH 8718181003803	95062900	STRAIGHT 42/107 CM LEASH
SIZE	MASTER CARTON INFO		
36 INCH   39 INCH   42 INCH	QUANTITY PER M. CARTON: 1 M. CARTON WEIGHT (KG): 1,53 M. CARTON WEIGHT (LBS): 3,366 M. CARTON SIZE (M): 0,53X0,08X0,97 M. CARTON SIZE (INCH): 20,67 X 2,95 X 37,99		



**CLAPPER BODYBOARD**

ITEM NUMBER	EAN CODE	HS CODE	FEATURES
286219002	39 INCH 8718181003810 42 INCH 8718181003827	95062900	COILED SWIVEL 42/107 CM LEASH COMFORTABLE ARM WELLS
SIZE	MASTER CARTON INFO		
39 INCH   42 INCH	QUANTITY PER M. CARTON: 1 M. CARTON WEIGHT (KG): 2,27 M. CARTON WEIGHT (LBS): 4,994 M. CARTON SIZE (M): 0,55 X 0,08 X 1,01 M. CARTON SIZE (INCH): 21,65 X 3,15 X 39,76		





**SHOV IT SKIMBOARD**

ITEM NUMBER	EAN CODE	HS CODE	FEATURES
286319001	32 INCH 8718181003841 36 INCH 8718181003865 41 INCH 8718181003872	95062900	9- LAYER MAPLE PLYWOOD LAMINATE CONSTRUCTION
<b>SIZE</b>		<b>MASTER CARTON INFO</b>	
32 INCH   36 INCH   41 INCH		QUANTITY PER M. CARTON: 1 M. CARTON WEIGHT (KG): 2,09 M. CARTON WEIGHT (LBS): 4,598 M. CARTON SIZE (M): 0,5X0,04X0,78 M. CARTON SIZE (INCH): 19,69X1,57X30,71	

**BODYBOARD LEASH COIL**

<i>ITEM NUMBER</i>	<i>EAN CODE</i>	<i>HS CODE</i>	<i>FEATURES</i>
289919001	PCS. 8718181003889	95062900	
<b>SIZE</b>		<b>MASTER CARTON INFO</b>	
PCS.		QUANTITY PER M. CARTON: 12 M. CARTON WEIGHT (KG): 2,76 M. CARTON WEIGHT (LBS): 6,072 M. CARTON SIZE (M): 0,55X0,18X0,21 M. CARTON SIZE (INCH): 21,65X7,09X8,27	



**BODYBOARD LEASH STRAIGHT**

<i>ITEM NUMBER</i>	<i>EAN CODE</i>	<i>HS CODE</i>	<i>FEATURES</i>
289919002	PCS. 8718181003896	95062900	
<b>SIZE</b>		<b>MASTER CARTON INFO</b>	
PCS.		QUANTITY PER M. CARTON: 12	
		M. CARTON WEIGHT (KG): 1,32	
		M. CARTON WEIGHT (LBS): 2,904	
		M. CARTON SIZE (M): 0,55X0,18X0,21	
		M. CARTON SIZE (INCH): 21,65X7,09X8,27	



**BOATING ACCESSORIES**



► ADDICT TOWER 1.1



► SWIVEL BOARD RACK



► SWIVEL WATERSKI RACK

**1.1 TOWER PACKAGE (SET)**

**ITEM NUMBER**

408818001

**EAN CODE**

PCS. 8718181256537

**HS CODE**

76169990

**FEATURES**

**TOWER:** 3 INCH DIAMETER POLISHED ALUMINIUM TUBES | FITS BOAT DECKS FROM 71 INCH / 193 CM TO 100 INCH / 254 CM IN WIDTH | CAN BE FOLDED DOWN FOR WINTER STORAGE

**SIZE**

PCS.

**MASTER CARTON INFO**

QUANTITY PER M. CARTON: 1  
 M. CARTON WEIGHT (KG): 23,1  
 M. CARTON WEIGHT (LBS): 50,82  
 M. CARTON SIZE (M): 1,99X0,77X0,2  
 M. CARTON SIZE (INCH): 78,35X30,31X7,87

**RACK:** RUBBER LAYER IN BETWEEN THE FORKS PROTECTS YOUR BOARDS OR SKIS | FINISHED WITH A HIGH-POLISHED ALUMINIUM





► ADDICT TOWER 1.3



► SWIVEL BOARD RACK



► SWIVEL WATERSKI RACK

### 1.3 TOWER PACKAGE (SET)

ITEM NUMBER	EAN CODE	HS CODE	FEATURES
408818002	PCS. 8718181256544	76169990	<b>TOWER:</b> 2INCH ANODIZED ALUMINIUM   2 TUBES CONNECT TO ITS HORIZONTAL BAR   FITS BOAT DECKS FROM 76/ 193 CM TO 100/ 254 CM IN WIDTH   ANODIZED ALUMINIUM, INCREASING CORROSION RESISTANCE AND SURFACE HARDNESS   CAN BE FOLDED DOWN FOR WINTER STORAGE
<b>SIZE</b>		<b>MASTER CARTON INFO</b>	<b>RACK:</b> RUBBER LAYER IN BETWEEN THE FORKS PROTECTS YOUR BOARDS OR SKIS   FINISHED WITH A HIGH-POLISHED ALUMINIUM   ITS BUNGEE CORD SECURELY HOLDS THE BOARDS
PCS.		QUANTITY PER M. CARTON: 1 M. CARTON WEIGHT (KG): 23,1 M. CARTON WEIGHT (LBS): 50,82 M. CARTON SIZE (M): 1,99X0,77X0,2 M. CARTON SIZE (INCH): 78,35X30,31X7,87	



► ADDICT TOWER 2.0



► SWIVEL BOARD RACK



► SWIVEL WATERSKI RACK

**2.0 TOWER PACKAGE (SET)**

ITEM NUMBER	EAN CODE	HS CODE	FEATURES
408818003	PCS. 8718181256551	76169990	<b>TOWER:</b> 2,5INCH ANODIZED ALUMINIUM   2 TUBES CONNECT TO ITS HORIZONTAL BAR   FITS BOAT DECKS FROM 76/ 193 CM TO 100/ 254 CM IN WIDTH   ANODIZED ALUMINIUM, INCREASING CORROSION RESISTANCE AND SURFACE HARDNESS   CAN BE FOLDED DOWN FOR WINTER STORAGE
<b>SIZE</b>		<b>MASTER CARTON INFO</b>	<b>RACK:</b> RUBBER LAYER IN BETWEEN THE FORKS PROTECTS YOUR BOARDS OR SKIS   FINISHED WITH A HIGH-POLISHED ALUMINIUM   ITS BUNGEE CORD SECURELY HOLDS THE BOARDS
PCS.		QUANTITY PER M. CARTON: 1 M. CARTON WEIGHT (KG): 23,1 M. CARTON WEIGHT (LBS): 50,82 M. CARTON SIZE (M): 1,99X0,77X0,2 M. CARTON SIZE (INCH): 78,35X30,31X7,87	





**ADDICT TOWER 1.1**

ITEM NUMBER	EAN CODE	HS CODE	FEATURES
400708002	PCS. 8718181023337	76169990	2 INCH DIAMETER POLISHED ALUMINIUM TUBES FITS BOAT DECKS FROM 71 INCH / 180CM TO 100 INCH / 254 CM IN WIDTH   CAN BE FOLDED DOWN FOR WINTER STORAGE
SIZE	MASTER CARTON INFO		
PCS.	QUANTITY PER M. CARTON: 1 M. CARTON WEIGHT (KG): 23,1 M. CARTON WEIGHT (LBS): 50,82 M. CARTON SIZE (M): 2X0,75X0,21 M. CARTON SIZE (INCH): 78,74X29,53X8,27		



**ADDICT TOWER 1.3**

ITEM NUMBER	EAN CODE	HS CODE	FEATURES
400709009	PCS. 8718181023405	76169990	2 INCH ANODIZED ALUMINIUM 2 TUBES CONNECT TO ITS HORIZONTAL BAR MORE RIGID AND STABLE   FITS BOAT DECKS FROM 76/ 193 CM TO 100/ 254 CM IN WIDTH ANODIZED ALUMINIUM, INCREASING CORROSION RESISTANCE AND SURFACE HARDNESS CAN BE FOLDED DOWN FOR WINTER STORAGE
SIZE	MASTER CARTON INFO		
PCS.	QUANTITY PER M. CARTON: 1	M. CARTON WEIGHT (KG): 34,65	
	M. CARTON WEIGHT (LBS): 76,23	M. CARTON SIZE (M): 1,9X0,85X0,21	
	M. CARTON SIZE (INCH): 74,8X33,46X8,27		



**ADDICT FORWARD TOWER 2.0**

ITEM NUMBER	EAN CODE	HS CODE	FEATURES
405417001	PCS. 8718181233965	76169990	2.5" DIAMETER POLISHED ALUMINIUM TUBES. FITS BOAT DECKS FROM 198/269CM 78INCH TO 101INCH WIDTH. COMPATIBLE WITH ALL JOBE ACCESSORIES COMBINED WITH OUR 2.5" INCH CLAMPS. CAN BE FOLDED DOWN FOR WINTER STORAGE.
<b>SIZE</b>	<b>MASTER CARTON INFO</b>		
PCS.	QUANTITY PER M. CARTON: 1 M. CARTON WEIGHT (KG): 23,1 M. CARTON WEIGHT (LBS): 50,82 M. CARTON SIZE (M): 1,9 X 0,6 X 0,19 M. CARTON SIZE (INCH): 74,8 X 23,62 X 7,48		



### ADDICT TOWER BIMINI

ITEM NUMBER	EAN CODE	HS CODE	FEATURES
405817001	M 8718181233989 L 8718181233996	63061200	MEDIUM: 1.35M (W) X 1.9M(L) OR 53IN(W) X 75IN (L). LARGE: 1.58M(W) X 1.9M(L) OR 62IN(W) X 75IN(L). CLAMPS: 2.5 INCH, 2.25 INCH AND 2 INCH TOWER LEG OUTSIDE DIAMETERS.
SIZE	MASTER CARTON INFO		
M   L	QUANTITY PER M. CARTON: 1 M. CARTON WEIGHT (KG): 13,86 M. CARTON WEIGHT (LBS): 30,492 M. CARTON SIZE (M): 1,61 X 0,49 X 0,11 M. CARTON SIZE (INCH): 63,39 X 19,29 X 4,33		



**ADDICT BOAT BIMINI**

ITEM NUMBER	EAN CODE	HS CODE	FEATURES
400816001	S 8718181201674 M 8718181201667 L 8718181201650	63061200	S: WIDTH 67INCH TO 72 INCH/ 170CM TO 183CM HEIGHT FRAME 1,45M. M:WIDTH 73INCH TO 78 INCH/ 185CM TO 198CM HEIGHT FRAME 1,45M. L:WIDTH 79INCH TO 84INCH/ 200CM TO 213,5CM HEIGHT FRAME 1,45M.
<b>SIZE</b>		<b>MASTER CARTON INFO</b>	
S   M   L		QUANTITY PER M. CARTON: 1 M. CARTON WEIGHT (KG): 16,5 M. CARTON WEIGHT (LBS): 36,3 M. CARTON SIZE (M): 1,57X0,4X0,11 M. CARTON SIZE (INCH): 61,81X15,75X4,33	UV-COATED NYLON TOP





### ADDICT CURVED MIRROR ARM WITH MIRROR

ITEM NUMBER	EAN CODE	HS CODE	FEATURES
400710004	PCS. 8718181023542	70099200	TOWER WITH 1.875-2 TUBING CURVY FOR A LARGER VIEWING AREA AND MORE SAFETY POLISHED ALUMINIUM
SIZE	MASTER CARTON INFO		
PCS.	QUANTITY PER M. CARTON:	1	
	M. CARTON WEIGHT (KG):	1,84	
	M. CARTON WEIGHT (LBS):	4,05	
	M. CARTON SIZE (M):	0,48X0,21X0,12	
	M. CARTON SIZE (INCH):	18,9X8,27X4,72	



**ADDICT SWIVEL BOARD RACK**

ITEM NUMBER	EAN CODE	HS CODE	FEATURES
405613004	PCS. 8718181121507	76169990	TOWER WITH 1.875-2 TUBING EASY SYSTEM TO CONNECT AND DISCONNECT RUBBER LAYER IN BETWEEN THE FORKS PROTECTS YOUR BOARDS FINISHED WITH A HIGH-POLISHED ALUMINIUM IT'S BUNGEE CORD SECURELY HOLDS THE BOARDS
SIZE	MASTER CARTON INFO		
PCS.	QUANTITY PER M. CARTON:	1	
	M. CARTON WEIGHT (KG):	3,3	
	M. CARTON WEIGHT (LBS):	7,26	
	M. CARTON SIZE (M):	0,4X0,19 X0,09	
	M. CARTON SIZE (INCH):	15,75X7,48 X3,54	

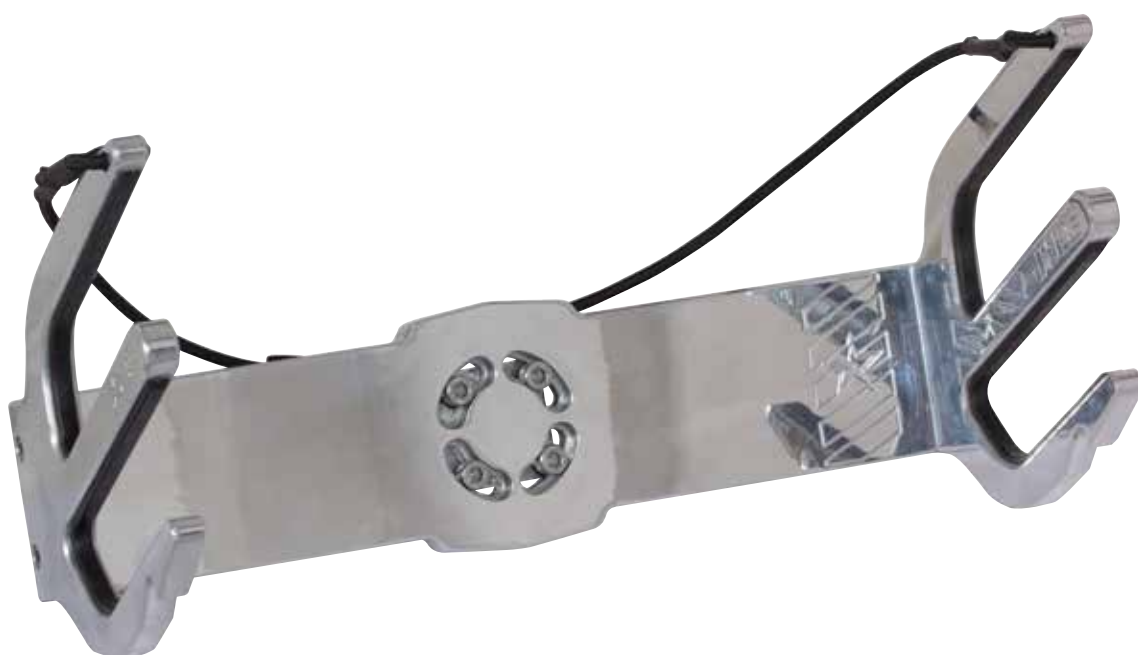

### ADDICT SWIVEL WATERSKI RACK

ITEM NUMBER	EAN CODE	HS CODE	FEATURES
405613006	PCS. 8718181121576	76169990	TOWER WITH 1.875-2 TUBING EASY SYSTEM TO CONNECT AND DISCONNECT RUBBER LAYER IN BETWEEN THE FORKS PROTECTS YOUR SKIS FINISHED WITH A HIGH-POLISHED ALUMINIUM IT'S BUNGEE CORD SECURELY HOLDS THE BOARDS
SIZE	MASTER CARTON INFO		
PCS.	QUANTITY PER M. CARTON:	1	
	M. CARTON WEIGHT (KG):	3,35	
	M. CARTON WEIGHT (LBS):	7,37	
	M. CARTON SIZE (M):	0,52 X 0,17 X 0,09	
	M. CARTON SIZE (INCH):	20,47 X 6,69 X 3,54	



**ADDICT WAKEBOARD|KNEEBOARD RACK**

ITEM NUMBER	EAN CODE	HS CODE	FEATURES
405613007	PCS. 8718181121590	76169990	TOWER WITH 1.875-2 TUBING EASY SYSTEM TO CONNECT AND DISCONNECT RUBBER LAYER IN BETWEEN THE FORKS PROTECTS YOUR BOARDS FINISHED WITH A HIGH-POLISHED ALUMINIUM IT'S BUNGEE CORD SECURELY HOLDS THE BOARDS
SIZE	MASTER CARTON INFO		
PCS.	QUANTITY PER M. CARTON:	1	
	M. CARTON WEIGHT (KG):	3,57	
	M. CARTON WEIGHT (LBS):	7,85	
	M. CARTON SIZE (M):	0,39 X 0,25 X 0,09	
	M. CARTON SIZE (INCH):	15,35 X 9,84 X 3,54	



### ADDICT PIVOTING SWIVEL BOARD RACK

ITEM NUMBER	EAN CODE	HS CODE	FEATURES
405614001	PCS. 8718181121422	76169990	TOWER WITH 1.875-2 TUBING EASY ACCESS TO YOUR BOARD FAST SYSTEM TO CONNECT AND DISCONNECT RUBBER LAYER IN BETWEEN THE FORKS PROTECTS YOUR BOARDS   FINISHED WITH A HIGH-POLISHED ALUMINIUM A BUNGEE CORD SECURELY HOLDS THE BOARDS SWINGS YOUR BOARDS IN A 90-DEGREE ANGLE
<b>SIZE</b>		<b>MASTER CARTON INFO</b>	
PCS.		QUANTITY PER M. CARTON:	1
		M. CARTON WEIGHT (KG):	4,29
		M. CARTON WEIGHT (LBS):	9,44
		M. CARTON SIZE (M):	0,52 X 0,17 X 0,09
		M. CARTON SIZE (INCH):	20,47 X 6,69 X 3,54

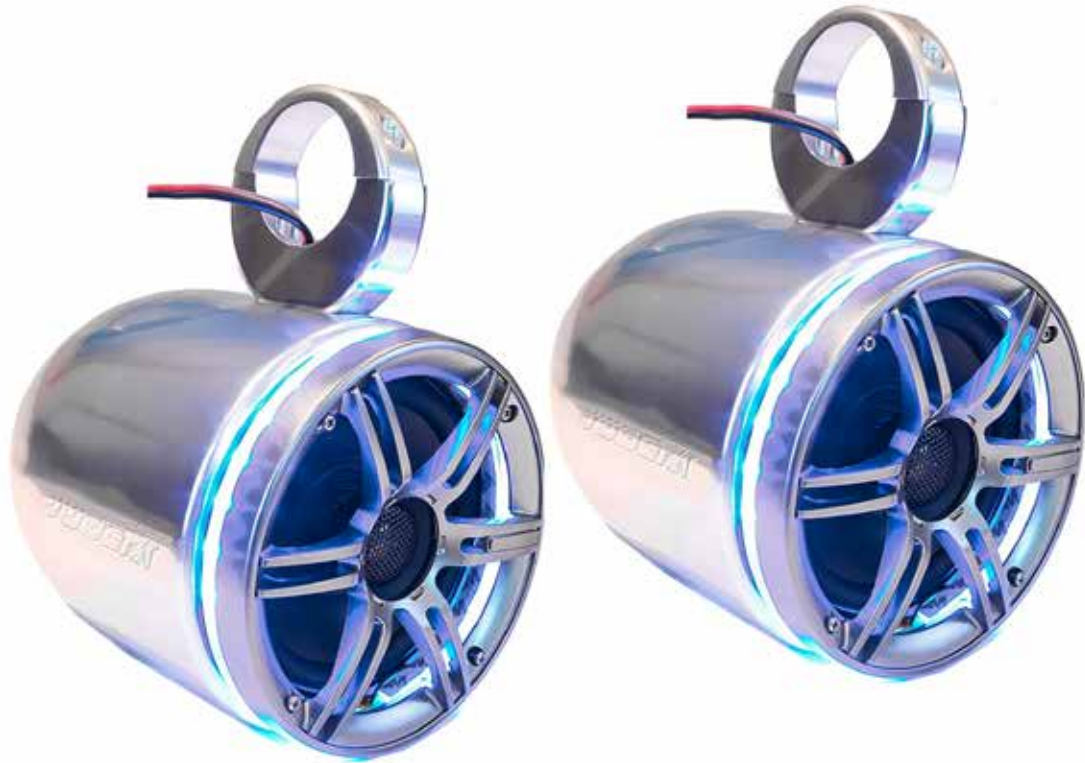

**ADDICT BULLET SPEAKERS**

ITEM NUMBER	EAN CODE	HS CODE	FEATURES
405617001	PCS. 8718181237208	76169990	4 OHM MARINE COAX SPEAKERS WITH LED LIGHTING AND BULLET ALUMINIUM HOUSING SHINING POLISHED CLAMPS FIT 1 3/4", 1 7/8", 2", 2 1/4", 2 3/8", 2 1/2" TUBE RMS: CONTINUOUS NOMINAL POWER HANDLING: 100W (EIA RS-426B 8HOURS) MAX POWER HANDLING: 250W (IEC268-5, 10MINUTES)
SIZE	MASTER CARTON INFO		
PCS.	QUANTITY PER M. CARTON:	1	
	M. CARTON WEIGHT (KG):	6,15	
	M. CARTON WEIGHT (LBS):	13,53	
	M. CARTON SIZE (M):	0,55X0,33X0,26	
	M. CARTON SIZE (INCH):	21,65X12,99X10,24	



### ADDICT LED LIGHT BAR

ITEM NUMBER	EAN CODE	HS CODE	FEATURES
405617002	PCS. 8718181234009	76169990	LED LIGHT COOL WHITE DAYLIGHT (6500K) PATENTED HYBRID TECHNOLOGY HIGH INTENSITY CREELEDS
SIZE	MASTER CARTON INFO		
PCS.	QUANTITY PER M. CARTON:	1	
	M. CARTON WEIGHT (KG):	2,89	
	M. CARTON WEIGHT (LBS):	6,358	
	M. CARTON SIZE (M):	0,6 X 0,13 X 0,12	
	M. CARTON SIZE (INCH):	23,62 X 4,92 X 4,72	



**ADDICT RACK CLAMP POLISHED 1.875"-2"**

ITEM NUMBER	EAN CODE	HS CODE	FEATURES
400709015	PCS. 8718181023450	76169990	CLAMP POLISHED 1.875-2
<b>SIZE</b>	<b>MASTER CARTON INFO</b>		
PCS.	QUANTITY PER M. CARTON: 30 M. CARTON WEIGHT (KG): 19,8 M. CARTON WEIGHT (LBS): 43,56 M. CARTON SIZE (M): 0,33X0,31X0,23 M. CARTON SIZE (INCH): 12,99X12,2X9,06		





### **ADDICT RACK CLAMP POLISHED 2.25"-2.5"**

<b>ITEM NUMBER</b>	<b>EAN CODE</b>	<b>HS CODE</b>	<b>FEATURES</b>
400709016	PCS. 8718181023467	76169990	CLAMP POLISHED 2.25-2.5
<b>SIZE</b>	<b>MASTER CARTON INFO</b>		
PCS.	QUANTITY PER M. CARTON: 30 M. CARTON WEIGHT (KG): 25,2 M. CARTON WEIGHT (LBS): 55,44 M. CARTON SIZE (M): 0,33X0,31X0,23 M. CARTON SIZE (INCH): 12,99X12,2X9,06		



**ADDICT RACK CLAMP ANODIZED 1.875"-2"**

ITEM NUMBER	EAN CODE	HS CODE	FEATURES
400709017	PCS. 8718181023474	76169990	CLAMP POLISHED 1.875-2
<b>SIZE</b>	<b>MASTER CARTON INFO</b>		
PCS.	QUANTITY PER M. CARTON: 30 M. CARTON WEIGHT (KG): 20,1 M. CARTON WEIGHT (LBS): 44,22 M. CARTON SIZE (M): 0,33X0,31X0,23 M. CARTON SIZE (INCH): 12,99X12,2X9,06		



### **ADDICT RACK CLAMP ANODIZED 2.25"-2.5"**

<b>ITEM NUMBER</b>	<b>EAN CODE</b>	<b>HS CODE</b>	<b>FEATURES</b>
400709018	PCS. 8718181023481	76169990	CLAMP POLISHED 2.25-2.5
<b>SIZE</b>	<b>MASTER CARTON INFO</b>		
PCS.	QUANTITY PER M. CARTON: 30 M. CARTON WEIGHT (KG): 25,2 M. CARTON WEIGHT (LBS): 55,44 M. CARTON SIZE (M): 0,33X0,31X0,23 M. CARTON SIZE (INCH): 12,99X12,2X9,06		



**WEBBING BUNGEE DOCK TIE**

ITEM NUMBER	EAN CODE	HS CODE	FEATURES
480018006	PCS. 8718181209137	95062900	7 FT/2.13 M MAINLINE STAINLESS STEEL HOOKS 2 FLOATS TO ATTACH YOUR BOARD TO THE DOCK
SIZE	MASTER CARTON INFO		
PCS.	QUANTITY PER M. CARTON:	20	
	M. CARTON WEIGHT (KG):	4,8	
	M. CARTON WEIGHT (LBS):	10,56	
	M. CARTON SIZE (M):	0,48 X 0,28 X 0,2	
	M. CARTON SIZE (INCH):	18,9 X 11,02 X 7,87	

**CONTOUR FENDER BLACK**

<b>ITEM NUMBER</b>	<b>EAN CODE</b>	<b>HS CODE</b>	<b>FEATURES</b>
400014005	L 8718181143462 XL 8718181143479	95062900	CONSTRUCTED OF A MARINE-GRADE TRI-LAMINATE COVER CLOSED-CELL FOAM POLYCARBONATE DURABLE GROMMETS AT EACH END SIZE L: 24"X6"X2-1/2" - 60CMX15CMX6CM SIZE XL: 30"X6"X4" - 78CMX15CMX9CM
<b>SIZE</b>	<b>MASTER CARTON INFO L</b>	<b>MASTER CARTON INFO XL</b>	
L   XL	QUANTITY PER M. CARTON: 12 M. CARTON WEIGHT (KG): 3,72 M. CARTON WEIGHT (LBS): 8,184 M. CARTON SIZE (M): 0,4 X 0,37 X 0,59 M. CARTON SIZE (INCH): 15,75 X 14,57 X 23,23	QUANTITY PER M. CARTON: 6 M. CARTON WEIGHT (KG): 3,96 M. CARTON WEIGHT (LBS): 8,73 M. CARTON SIZE (M): 0,36 X 0,33 X 0,82 M. CARTON SIZE (INCH): 14,17 X 12,99 X 32,28	



**EMERGENCY CORD**

ITEM NUMBER	EAN CODE	HS CODE	FEATURES
420008003	PCS. 8718181023955	95062900	FITS ALMOST ALL BOATS AND PWC'S COILED CORD DIFFERENT KEYS TO FIT ALMOST ALL BOATS PADDED WRIST SEAL
<b>SIZE</b>		<b>MASTER CARTON INFO</b>	
PCS.		QUANTITY PER M. CARTON: 24 M. CARTON WEIGHT (KG): 2,64 M. CARTON WEIGHT (LBS): 5,808 M. CARTON SIZE (M): 0,35X0,25X0,38 M. CARTON SIZE (INCH): 13,7X9,72X14,96	

**BOAT MIRROR**

<b>ITEM NUMBER</b>	<b>EAN CODE</b>	<b>HS CODE</b>	<b>FEATURES</b>
420805004	PCS. 0047662111194	70099200	UNIVERSAL MODEL MIRROR FULLY ADJUSTABLE CONVEX MIRROR QUICK-MOUNT SYSTEM INSTALLED ABOVE OR BELOW THE WINDSCREEN OR ON THE DASHBOARD
<b>SIZE</b>		<b>MASTER CARTON INFO</b>	
PCS.		QUANTITY PER M. CARTON: 48 M. CARTON WEIGHT (KG): 21,12 M. CARTON WEIGHT (LBS): 46,464 M. CARTON SIZE (M): 0,08X0,25X0,19 M. CARTON SIZE (INCH): 3X9,75X7,5	



**SUCTION CUP MIRROR**

<b>ITEM NUMBER</b>	<b>EAN CODE</b>	<b>HS CODE</b>	<b>FEATURES</b>
420709001	PCS. 0047662110500	70099200	FULLY ADJUSTABLE MIRROR ATTACH TO A CLEAN, NON-POROUS SURFACE 100% SCRATCH FREE
<b>SIZE</b>		<b>MASTER CARTON INFO</b>	
PCS.		QUANTITY PER M. CARTON: 16 M. CARTON WEIGHT (KG): 7,04 M. CARTON WEIGHT (LBS): 15,488 M. CARTON SIZE (M): 0,1X0,26 X0,27 M. CARTON SIZE (INCH): 4X10,25X10,75	



**SAFETY MIRROR**

<b>ITEM NUMBER</b>	<b>EAN CODE</b>	<b>HS CODE</b>	<b>FEATURES</b>
420805003	PCS. 0047662111408	70099200	UNIVERSAL INTERIOR MIRROR MOUNTS JUST ABOVE OR BELOW THE WINDSCREEN IT FITS FRAMES FROM 5 / 8 (1.1 CM) TO 1.0 (2.5 CM) THICK ADJUSTABLE ANTI-SCRATCH QUICK MOUNT BRACKET
<b>SIZE</b>	<b>MASTER CARTON INFO</b>		
PCS.	QUANTITY PER M. CARTON: 24 M. CARTON WEIGHT (KG): 10,56 M. CARTON WEIGHT (LBS): 23,232 M. CARTON SIZE (M): 0,27X0,1X0,3 M. CARTON SIZE (INCH): 10,5X4X11,75		



**SLALOM BUOY ORANGE**

<i>ITEM NUMBER</i>	<i>EAN CODE</i>	<i>HS CODE</i>	<i>FEATURES</i>
420016002	PCS. 8718181207201	95062900	
<b>SIZE</b>		<b>MASTER CARTON INFO</b>	
PCS.		QUANTITY PER M. CARTON: 40	
		M. CARTON WEIGHT (KG): 12,4	
		M. CARTON WEIGHT (LBS): 27,28	
		M. CARTON SIZE (M): 0,42X0,4X0,29	
		M. CARTON SIZE (INCH): 16,54X15,75X11,22	



### SLALOM BUOY YELLOW

ITEM NUMBER	EAN CODE	HS CODE	FEATURES
420016003	PCS. 8718181207225	95062900	
SIZE	MASTER CARTON INFO		
PCS.	QUANTITY PER M. CARTON:	40	
	M. CARTON WEIGHT (KG):	12,4	
	M. CARTON WEIGHT (LBS):	27,28	
	M. CARTON SIZE (M):	0,42X0,4X0,29	
	M. CARTON SIZE (INCH):	16,54X15,75X11,22	



**SLALOM BUOY GREEN**

ITEM NUMBER	EAN CODE	HS CODE	FEATURES
420016004	PCS. 8718181207249	95062900	
<b>SIZE</b>	<b>MASTER CARTON INFO</b>		
PCS.	QUANTITY PER M. CARTON: 40 M. CARTON WEIGHT (KG): 12,4 M. CARTON WEIGHT (LBS): 27,28 M. CARTON SIZE (M): 0,42X0,4X0,29 M. CARTON SIZE (INCH): 16,54X15,75X11,22		



---

#### JOBE HEAVY DUTY

*The name 'Heavy Duty Series', says it all! These products are made out of heavy duty materials, which make it the most sustainable rental water sports gear out there. It guarantees your water sports organization is able to run at full swing all day long without product failure. The Jobe Heavy Duty products are created with a clear concept in mind. The main colour of the collection is yellow to create uniformity in the collection and to make your rental organization stand out and recognizable. The Jobe Heavy Duty Series is the perfect concept for, for example beach clubs and wake parks.*

---

**HEAVY DUTY**

# SIZING HEAVY DUTY

## HEAVY DUTY WETSUITS

SIZE	ADULT								
	CHEST (CM)	CHEST (INCH)	WAIST (CM)	WAIST (INCH)	HIP (CM)	HIP (INCH)	LENGTH (CM)	LENGTH (INCH)	SIZE COLOR
2XS	86-90	33,9-35,4	76-80	29,9-31,5	86-90	33,9-35,4	171-177	67,3-69,7	PURPLE
XS	90-94	35,4-37	80-84	31,5-33,1	90-94	35,4-37	173-179	68,1-70,5	GREEN
S	94-98	37-38,6	84-88	33,1-34,6	94-98	37-38,6	175-181	68,9-71,3	YELLOW
M	98-102	38,6-40,2	88-92	34,6-36,2	98-102	38,6-40,2	177-183	69,7-72	RED
L	102-106	40,2-41,7	92-96	36,2-37,8	102-106	40,2-41,7	179-185	70,5-72,8	BLUE
XL	106-110	41,7-43,3	96-100	37,8-39,4	106-110	41,7-43,3	181-187	71,3-73,6	GREY
2XL	111-117	43,7-46,1	101-107	39,8-42,1	111-117	43,7-46,1	183-189	72-74,4	BLACK
3XL	117-123	46,1-48,4	107-113	42,1-44,5	117-123	46,1-48,4	185-191	72,8-75,2	DARK BLUE

SIZE	YOUTH								
	CHEST (CM)	CHEST (INCH)	WAIST (CM)	WAIST (INCH)	HIP (CM)	HIP (INCH)	LENGTH (CM)	LENGTH (INCH)	SIZE COLOR
2XS	54-58	21,3-22,8	50-53	19,7-20,9	51-55	20,1-21,7	≤104	≤40,9	PURPLE
XS	58-60	22,8-23,6	53-55	20,9-21,7	55-61	21,7-24	≤116	≤45,7	GREEN
S	60-63	23,6-24,8	55-59	21,7-23,2	61-67	24-26,4	≤128	≤50,4	YELLOW
M	62-66	24,4-26	57-61	22,4-24	64-70	25,2-27,6	≤134	≤52,8	RED
L	63-70	24,8-27,6	59-63	23,2-24,8	67-73	26,4-28,7	≤146	≤57,5	BLUE
XL	70-76	27,6-29,9	63-69	24,8-27,2	73-79	28,7-31,1	≤152	≤59,8	GREY
2XL	76-83	29,9-32,7	69-74	27,2-29,1	79-85	31,1-33,5	≤164	≤64,6	BLACK
3XL	83-89	32,7-35	74-78	29,1-30,7	85-91	33,5-35,8	≤176	≤69,3	DARK BLUE

## HEAVY DUTY VESTS

	HEAVY DUTY & HEAVY DUTY MONITEUR (CERTIFIED 50N)				
	CHEST (CM)	CHEST (INCH)	WAIST (CM)	WAIST (INCH)	COLOR WEBBING
2XS	85-91	33,5-35,8	75-81	29,5-31,9	PURPLE
XS	89-95	35-37,4	79-85	31,1-33,5	GREEN
S	93-99	36,6-39	83-89	32,7-35	YELLOW
M	97-103	38,2-40,6	87-93	34,3-36,6	RED
L	101-107	39,8-42,1	91-97	35,8-38,2	BLUE
XL	105-113	41,3-44,5	95-103	37,4-40,6	GREY
2XL	111-119	43,7-46,9	101-109	39,8-42,9	BLACK
3XL	117-125	46,1-49,2	107-115	42,1-45,3	DARK BLUE

## HEAVY DUTY WAKEBOARDS

SIZE (INCH)	132 CM   52"	137 CM   53,9"	142 CM   55,9"
INSERT SETUP	6" +DRIFT	6" +DRIFT	6" +DRIFT
TIP/TAIL WIDTH	30,6 CM   12"	29,6 CM   11,7"	30,6 CM   12,1"
CENTER WIDTH	44 CM   17,3"	44 CM   17,3"	42,5 CM   16,7"
ROCKER + HEIGHT	2,9/3-STAGE	2,9/3-STAGE	2,8/3-STAGE
BOARD LEVEL	INT./ADVANCED	INT./ADVANCED	INT./ADVANCED
RIDER WEIGHT KG	80 AND UP	70-100	80 AND UP

WE ARE CONSTANTLY WORKING ON THE SIZING OF OUR PRODUCTS. CHECK OUT [JOBESPORTS.COM](http://JOBESPORTS.COM) FOR THE MOST UP TO DATE, IMPROVED SIZING!  
ALL MEASUREMENTS ARE FOR REFERENCE ONLY.



# HEAVY DUTY VEST TECHNOLOGY

---

500D NYLON FABRIC  
LIGHTWEIGHT AND DURABLE

EPE FOAM  
LIGHTWEIGHT

NYLON FABRIC  
LIGHTWEIGHT AND DURABLE

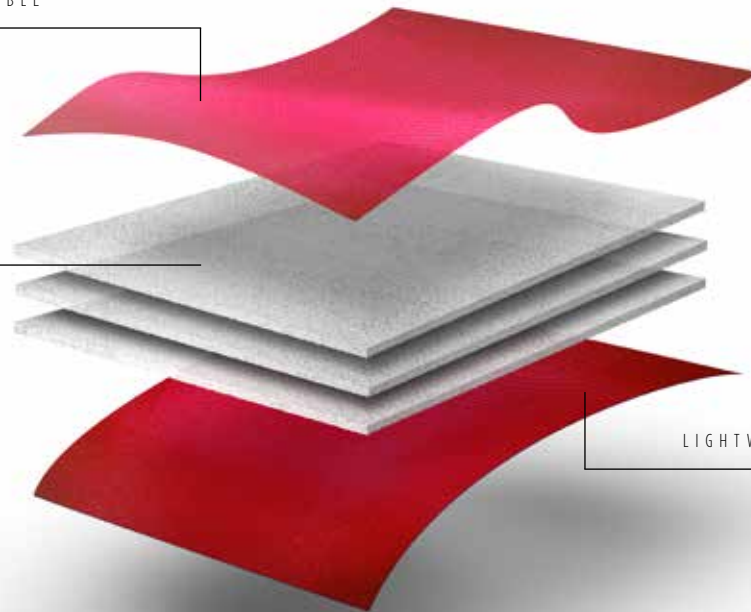

# HEAVY DUTY WETSUIT TECHNOLOGY

REINFORCED POLYESTER TOP LAYER FOR EXCELLENT STRETCH, A SMOOTH FEELING AND DURABLE

SCR FOAM FOR A COMFORTABLE FEELING AND PROTECTION

REINFORCED POLYESTER BOTTOM LAYER FOR EXCELLENT STRETCH, A SMOOTH FEELING AND DURABLE

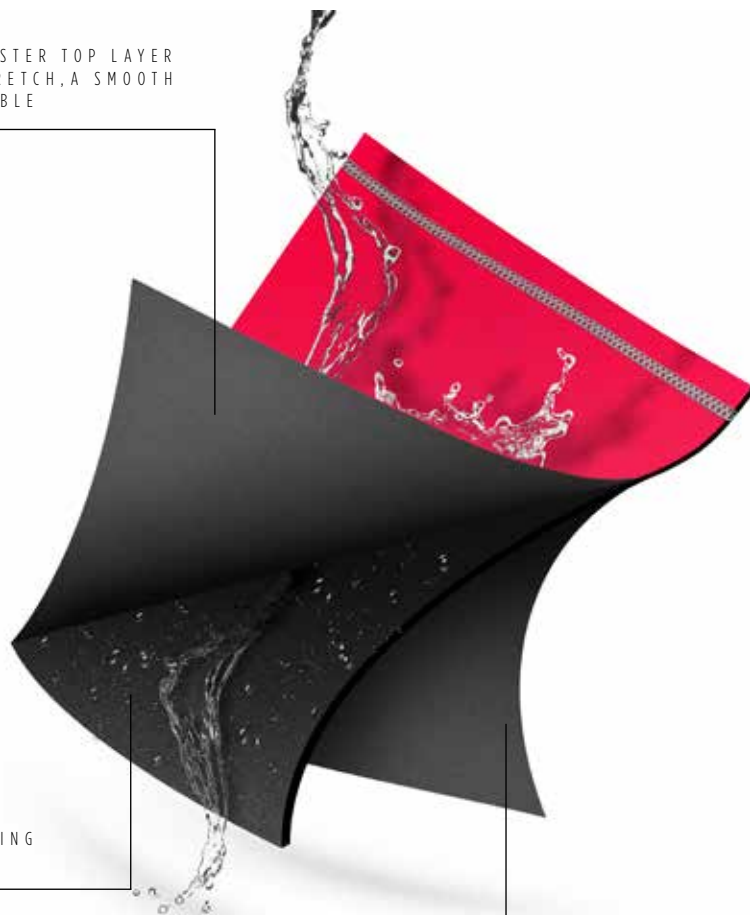

## FLATLOCK STITCHING TECHNIQUE

FLATLOCK STITCHING IS THE MOST COMMON FORM OF SEAM STITCHING AND BY FAR THE MOST DURABLE. FLATLOCK WORKS BY OVERLAPPING THE NEOPRENE PANELS AND SEWING THEM TOGETHER. THE PROCESS OF FLATLOCK STITCHING ADDS TINY HOLES THROUGH THE NEOPRENE WHICH IN TURN ALLOWS COLD WATER TO ENTER THE SUIT. FOR THAT REASON, FLATLOCK STITCHED WETSUITS ARE NOT DESIGNED FOR REALLY COLD WATER.

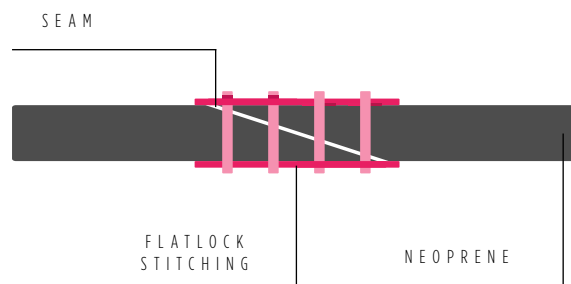



# HEAVY DUTY TOWABLE TECHNOLOGY

NEOPRENE PADS  
FOR A COMFORTABLE RIDE  
FULLY GLUED AND  
STITCHED TO THE COVER

DENIERS VARY FROM  
840D UP TO 1680D

BOSTON VALVE FOR  
QUICK INFLATION  
AND DEFLATION

34 GAUGES USED FOR  
FOR COMMERCIAL  
PRODUCTS, THICKEST  
MATERIAL USED IN  
THE INDUSTRY

EXTRA STRONG  
TOWPOINT BECAUSE OF  
REINFORCED WEBBINGS



FOAM FILLED  
HANDLES WITH  
NEOPRENE  
KNUCKLEGUARDS  
FOR MAXIMUM  
GRIP AND COMFORT

NYLON REINFORCEMENT  
PATCHES BEHIND THE  
HANDLES:  
EXTRA DURABLE DUE  
TO THE REINFORCEMENT

NYLON REINFORCEMENT PATCHES  
BEHIND THE TOWPOINT:  
A DURABLE AND STRONG  
TOWPOINT

EASY ENTRY  
WEBBING HANDLES  
GET BACK ON THE  
TOWABLE WITHOUT  
ANY PROBLEM

QUICK CONNECTOR BUCKLE  
TO CONNECT THE  
TOWROPE IN A FEW SECONDS

TARPAULIN BOTTOM ON BIGGER  
TOWABLES FOR MORE SPEED

DOUBLE TOWPOINT FOR  
THE SIGMA 6P, SONAR  
4P AND SONAR 6P

# HEAVY DUTY SLALOM SKI TECHNOLOGY

WRAPPED FIBERGLASS  
EXTRA EDGE REINFORCEMENT

HIGH QUALITY TPU  
GRAPHIC TOP LAYER

EXTRA FIBERGLASS REINFORCEMENT

LIGHTWEIGHT SOLID FOAM CORE

HIGH QUALITY TPU BOTTOM LAYER

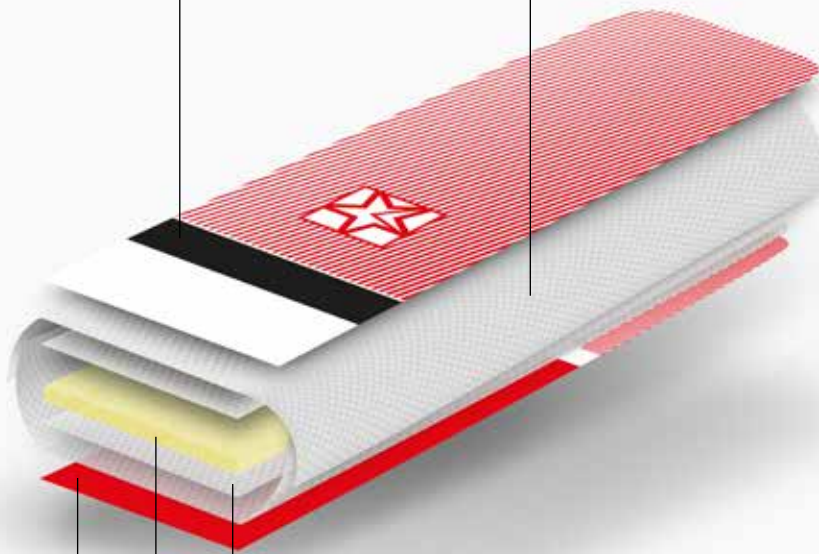

# HEAVY DUTY WAKEBOARD TECHNOLOGY

---

TRIAXIAL LAYUP:  
PERFECT STRENGTH AND FLEX

SCRATCH FREE TOPLAYER

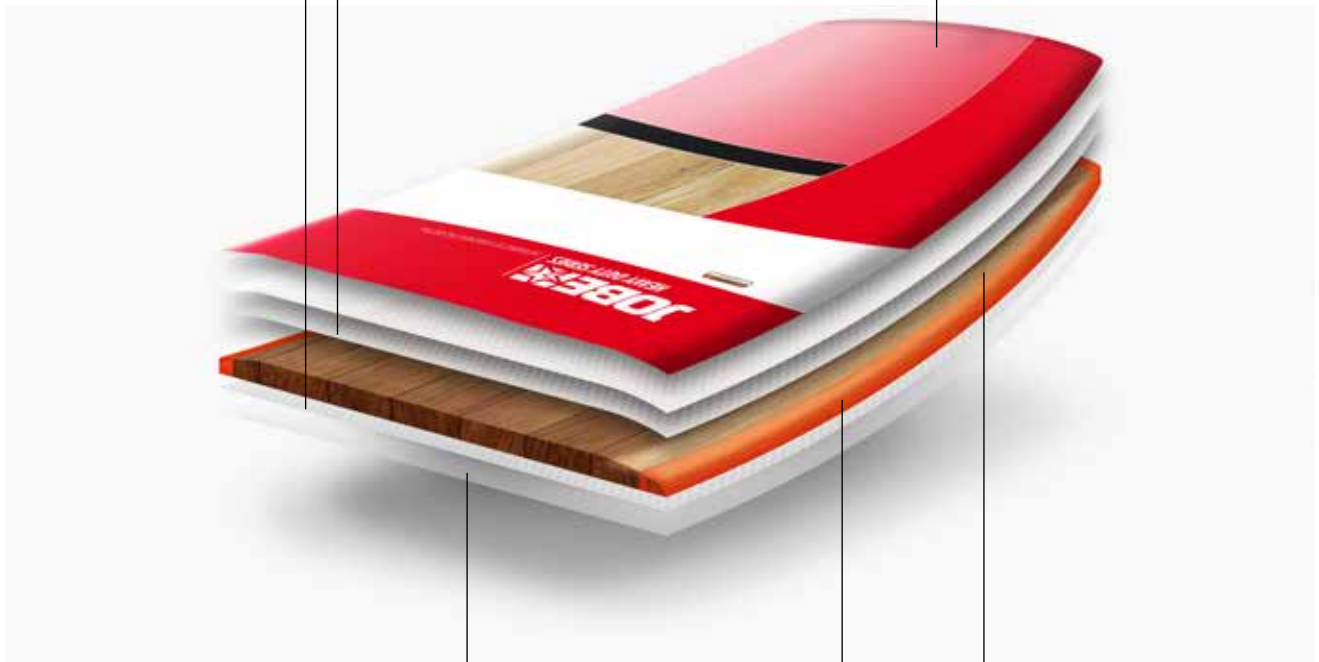

DURABLE AND  
STRONG WOOD CORE

ABS SIDE PROTECTION

HIGH IMPACT BOTTOM LAYER:  
HIGH QUALITY GRAPHIC



### WATERSPORTS LOCATION FLAG

ITEM NUMBER	EAN CODE	HS CODE	FEATURES
443617001	PCS 8718181232067	63079098	90CM WIDE X 210CM HIGH INCLUDING GROUND SCREW, POLE AND TRANSPORT BAG
SIZE	MASTER CARTON INFO		
PCS.	QUANTITY PER M. CARTON: 10 M. CARTON WEIGHT (KG): 63,8 M. CARTON WEIGHT (LBS): 140,65 M. CARTON SIZE (M): 1,46 X 0,35 X 0,25 M. CARTON SIZE (INCH): 57,48 X 13,78 X 9,84		



### HEAVY DUTY STANDING BUOY

ITEM NUMBER	EAN CODE	HS CODE	FEATURES
442317001	PCS. 8718181222907	95062900	EXTRA STRONG PVC ANCHOR WITH 5 M NON-FLOATING ROPE
SIZE	MASTER CARTON INFO		
PCS.	QUANTITY PER M. CARTON: 4 M. CARTON WEIGHT (KG): 21,2 M. CARTON WEIGHT (LBS): 46,64 M. CARTON SIZE (M): 0,53 X 0,47 X 0,4 M. CARTON SIZE (INCH): 20,87 X 18,5 X 15,75		

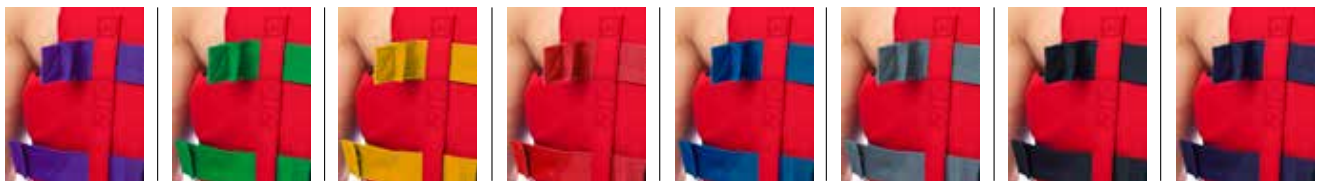

► XXS - PURPLE    ► XS - GREEN    ► S - YELLOW    ► M - RED    ► L - BLUE    ► XL - GREY    ► XXL - BLACK    ► XXXL - DARK BLUE

**HEAVY DUTY VEST RED**

ITEM NUMBER	EAN CODE	HS CODE	FEATURES
442418001	2XS 8718181251129 XS 8718181251105 S 8718181251082	63072000	50N ISO-CERTIFIED (BUOYANCY AID) LIGHTWEIGHT PE-FOAM STRONG & LIGHTWEIGHT 600 DENIER NYLON FABRIC 1,5" ADJUSTABLE WEBBING STRAPS (3X) STRONG YKK BUCKLES
<b>SIZE</b>	M 8718181251075 L 8718181251068 XL 8718181251099 2XL 8718181251112 3XL 8718181251136	<b>MASTER CARTON INFO</b>	ALWAYS A PERFECT FIT: MORE COMFORT AND SAFETY WATER DRAINAGE SYSTEM COLORED WEBBING STRAPS FOR SIZE INDICATION UNISEX FIT
2XS   XS   S   M   L   XL   2XL   3XL		QUANTITY PER M. CARTON: 10 M. CARTON WEIGHT (KG): 7,4 M. CARTON WEIGHT (LBS): 16,28 M. CARTON SIZE (M): 0,8 X 0,6 X 0,4 M. CARTON SIZE (INCH): 31,5 X 23,62 X 15,75	



► XXS - PURPLE    ► XS - GREEN    ► S - YELLOW    ► M - RED    ► L - BLUE    ► XL - GREY    ► XXL - BLACK    ► XXXL - DARK BLUE

**HEAVY DUTY VEST YELLOW**

ITEM NUMBER	EAN CODE	HS CODE	FEATURES
442418003	2XS 8718181253154 XS 8718181253130 S 8718181253116	63072000	50N ISO-CERTIFIED (BUOYANCY AID) LIGHTWEIGHT PE-FOAM STRONG & LIGHTWEIGHT 600 DENIER NYLON FABRIC 1,5" ADJUSTABLE WEBBING STRAPS (3X) STRONG YKK BUCKLES
<b>SIZE</b>	M 8718181253109 L 8718181253093 XL 8718181253123 2XL 8718181253147 3XL 8718181253161	<b>MASTER CARTON INFO</b>	ALWAYS A PERFECT FIT: MORE COMFORT AND SAFETY WATER DRAINAGE SYSTEM COLORED WEBBING STRAPS FOR SIZE INDICATION UNISEX FIT
2XS   XS   S   M   L   XL   2XL   3XL		QUANTITY PER M. CARTON: 10 M. CARTON WEIGHT (KG): 6,6 M. CARTON WEIGHT (LBS): 14,52 M. CARTON SIZE (M): 0,8 X 0,6 X 0,4 M. CARTON SIZE (INCH): 31,5 X 23,62 X 15,75	



► POCKET FOR PORTPHONE



► POCKET FOR MOBILE PHONE

### HEAVY DUTY MONITEUR VEST

ITEM NUMBER	EAN CODE	HS CODE	FEATURES
442418002	2XS 8718181251280 XS 8718181251266 S 8718181251242	63072000	50N ISO-CERTIFIED (BUOYANCY AID) SOFT PVC FOAM STRONG & LIGHTWEIGHT 600 DENIER NYLON FABRIC 1,5" ADJUSTABLE WEBBING STRAPS (3X) STRONG YKK BUCKLES
<b>SIZE</b>	M 8718181251235 L 8718181251228	<b>MASTER CARTON INFO</b>	ALWAYS A PERFECT FIT: MORE COMFORT AND SAFETY SAFETY D-RING FOR ATTACHMENT EMERGENCY CORD POCKET FOR PORTPHONE POCKET FOR MOBILE PHONE WATER DRAINAGE SYSTEM UNISEX FIT
2XS   XS   S   M   L   XL   2XL   3XL	XL 8718181251259 2XL 8718181251273 3XL 8718181251297	QUANTITY PER M. CARTON: 10 M. CARTON WEIGHT (KG): 6,6 M. CARTON WEIGHT (LBS): 14,52 M. CARTON SIZE (M): 0,8 X 0,6 X 0,45 M. CARTON SIZE (INCH): 31,5 X 23,62 X 17,72	





► 2XS - PURPLE    ► XS - GREEN    ► S - YELLOW    ► M - RED    ► L - BLUE    ► XL - GREY    ► 2XL - BLACK    ► 3XL - DARK BLUE

**HEAVY DUTY FULLSUIT 5/3MM YOUTH**

ITEM NUMBER	EAN CODE	HS CODE	FEATURES
443019040	2XS 8718181007641 XS 8718181007702 S 8718181007689	61130010	5MM NEOPRENE ON CHEST & BACK, 3MM ON OTHER PANELS REGULAR STRETCH NEOPRENE GLUED & BLIND STITCHED SEAMS: NO WATER ENTRY THROUGH SEAMS
<b>SIZE</b>	M 8718181007672 L 8718181007665 XL 8718181007696 2XL 8718181007634 3XL 8718181007658	<b>MASTER CARTON INFO</b>	STRENGTHENING TAPE INSIDE BACK ZIPPER FOR FAST ENTRY PROTECTIVE STRONG FABRIC AT HIPS & LEGS SLANT ANKLE OPENING FOR EASY ENTRY COLORED PRINT FOR SIZE INDICATION FRONT & BACK INSTRUCT PRINT INSIDE UNISEX FIT
2XS   XS   S   M   L   XL   2XL   3XL		QUANTITY PER M. CARTON: 10 M. CARTON WEIGHT (KG): 12,5 M. CARTON WEIGHT (LBS): 27,5 M. CARTON SIZE (M): 0,91 X 0,46 X 0,25 M. CARTON SIZE (INCH): 36 X 18 X 10	



► 2XS - PURPLE

► XS - GREEN

► S - YELLOW

► M - RED

► L - BLUE

► XL - GREY

► 2XL - BLACK

► 3XL - DARK BLUE

**HEAVY DUTY SHORTY 2.5/2MM**

ITEM NUMBER	EAN CODE	HS CODE	FEATURES
443019030	2XS 8718181007566 XS 8718181007627 S 8718181007603	61130010	2.5MM NEOPRENE ON CHEST & BACK, 2MM ON OTHER PANELS REGULAR STRETCH NEOPRENE SOFT & FLEXIBLE STITCHED SEAMS STRENGTHENING TAPE INSIDE BACK ZIPPER FOR FAST ENTRY
<b>SIZE</b>	M 8718181007597 L 8718181007580 XL 8718181007610 2XL 8718181007559 3XL 8718181007573	<b>MASTER CARTON INFO</b>	PROTECTIVE STRONG FABRIC AT HIPS & LEGS COLORED PRINT FOR SIZE INDICATION FRONT & BACK INSTRUCT PRINT INSIDE UNISEX FIT
2XS   XS   S   M   L   XL   2XL   3XL		QUANTITY PER M. CARTON: 10 M. CARTON WEIGHT (KG): 9,1 M. CARTON WEIGHT (LBS): 20,02 M. CARTON SIZE (M): 1,19 X 0,53 X 0,11 M. CARTON SIZE (INCH): 47 X 21 X 4,5	



► 2XS - PURPLE    ► XS - GREEN    ► S - YELLOW    ► M - RED    ► L - BLUE    ► XL - GREY    ► 2XL - BLACK    ► 3XL - DARK BLUE

**HEAVY DUTY FULLSUIT 3|2.5MM**

ITEM NUMBER	EAN CODE	HS CODE	FEATURES
443019010	2XS 8718181007474 XS 8718181007542 S 8718181007528	61130010	3MM NEOPRENE ON CHEST & BACK, 2.5MM ON OTHER PANELS REGULAR STRETCH NEOPRENE SOFT & FLEXIBLE STITCHED SEAMS STRENGTHENING TAPE INSIDE BACK ZIPPER FOR FAST ENTRY
<b>SIZE</b>	M 8718181007511 L 8718181007504 XL 8718181007535 2XL 8718181007467 3XL 8718181007481	<b>MASTER CARTON INFO</b>	PROTECTIVE STRONG FABRIC AT HIPS & LEGS SLANT ANKLE OPENING FOR EASY ENTRY COLORED PRINT FOR SIZE INDICATION FRONT & BACK INSTRUCT PRINT INSIDE UNISEX FIT
2XS   XS   S   M   L   XL   2XL   3XL		QUANTITY PER M. CARTON: 10 M. CARTON WEIGHT (KG): 18 M. CARTON WEIGHT (LBS): 39,6 M. CARTON SIZE (M): 1,02 X 0,56 X 0,18 M. CARTON SIZE (INCH): 40 X 22 X 7	



▶ 2XS - PURPLE

▶ XS - GREEN

▶ S - YELLOW

▶ M - RED

▶ L - BLUE

▶ XL - GREY

▶ 2XL - BLACK

▶ 3XL - DARK BLUE

**HEAVY DUTY FULLSUIT 5|3MM**

ITEM NUMBER	EAN CODE	HS CODE	FEATURES
443019000	2XS 8718181007399 XS 8718181007450 S 8718181007436	61130010	5MM NEOPRENE ON CHEST & BACK, 3MM ON OTHER PANELS REGULAR STRETCH NEOPRENE GLUED & BLIND STITCHED SEAMS: NO WATER ENTRY THROUGH SEAMS
<b>SIZE</b>	M 8718181007429 L 8718181007412 XL 8718181007443 2XL 8718181007382 3XL 8718181007405	<b>MASTER CARTON INFO</b>	STRENGTHENING TAPE INSIDE BACK ZIPPER FOR FAST ENTRY PROTECTIVE STRONG FABRIC AT HIPS & LEGS SLANT ANKLE OPENING FOR EASY ENTRY COLORED PRINT FOR SIZE INDICATION FRONT & BACK INSTRUCT PRINT INSIDE UNISEX FIT
2XS   XS   S   M   L   XL   2XL   3XL		QUANTITY PER M. CARTON: 10 M. CARTON WEIGHT (KG): 18 M. CARTON WEIGHT (LBS): 39,6 M. CARTON SIZE (M): 0,97 X 0,51 X 0,25 M. CARTON SIZE (INCH): 38 X 20 X 10	





**HEAVY DUTY HOTSEAT TOWABLE 1P**

ITEM NUMBER	EAN CODE	HS CODE	FEATURES
442317011	PCS. 8718181222921	95062900	MAX 1 PERSONS TOWABLE DOUBLE DENIER NYLON COVER (840 +420 NYLON) 34 GAUGE PVC - K80 ONE WAY BOSTON VALVE QUICK ROPE CONNECTOR 4 REINFORCED HANDLES WITH NEOPRENE KNUCKLE GUARDS NEOPRENE SEAT PAD THREE-DOUBLE-STITCHED DEFLATED SIZE : Ø50"   Ø128 CM
<b>SIZE</b>		<b>MASTER CARTON INFO</b>	
PCS.		QUANTITY PER M. CARTON: 3 M. CARTON WEIGHT (KG): 14,43 M. CARTON WEIGHT (LBS): 31,746 M. CARTON SIZE (M): 0,47 X 0,43 X 0,37 M. CARTON SIZE (INCH): 18,5 X 16,93 X 14,57	



### HEAVY DUTY TRIBAL TOWABLE 2P

ITEM NUMBER	EAN CODE	HS CODE	FEATURES
442318021	PCS. 8718181000628	95062900	1680 DENIER NYLON COVER 30 GAUGE PVC MAX 2 PERSONS TOWABLE ONE WAY VALVE QUICK CONNECTOR
<b>SIZE</b>		<b>MASTER CARTON INFO</b>	4 HANDLES WITH KNUCKLE PROTECTING NEOPRENE EASY ENTRY AIR FLOOR NEOPRENE SEAT PADS TRIPPLE-STITCHED NYLON DEFLATED SIZE : 66" X 55", 168 X 140CM
PCS.		QUANTITY PER M. CARTON: 2 M. CARTON WEIGHT (KG): 11,22 M. CARTON WEIGHT (LBS): 24,684 M. CARTON SIZE (M): 0,45 X 0,38 X 0,55 M. CARTON SIZE (INCH): 17,72 X 14,96 X 21,65	



**HEAVY DUTY SHIELD TOWABLE 4P**

ITEM NUMBER	EAN CODE	HS CODE	FEATURES
442317041	PCS. 8718181222891	95062900	MAX 4 PERSONS TOWABLE DOUBLE 840 DENIER NYLON COVER 34 GAUGE PVC - K80 ONE WAY BOSTON VALVE QUICK ROPE CONNECTOR 8 REINFORCED HANDLES WITH NEOPRENE KNUCKLE GUARDS 4 NEOPRENE HANDLES STRONG AND FAST TARPAULIN BOTTOM NEOPRENE SEAT PAD THREE-DOUBLE-STITCHED DEFLATED SIZE : Ø92.5"   Ø235 CM
<b>SIZE</b>		<b>MASTER CARTON INFO</b>	
PCS.		QUANTITY PER M. CARTON: 1 M. CARTON WEIGHT (KG): 22,57 M. CARTON WEIGHT (LBS): 49,654 M. CARTON SIZE (M): 0,49 X 0,25 X 0,6 M. CARTON SIZE (INCH): 19,29 X 9,84 X 23,62	





### HEAVY DUTY AIRSTREAM TOWABLE 4P

ITEM NUMBER	EAN CODE	HS CODE	FEATURES
442317042	PCS. 8718181222969	95062900	MAX 4 PERSONS TOWABLE DOUBLE 840 DENIER NYLON COVER 34 GAUGE PVC - K80 ONE WAY BOSTON VALVE QUICK ROPE CONNECTOR 8 REINFORCED HANDLES WITH NEOPRENE KNUCKLE GUARDS 4 NEOPRENE HANDLES STRONG AND FAST TARPAULIN BOTTOM NEOPRENE SEAT PAD THREE-DOUBLE-STITCHED DEFLATED SIZE : 90.5"X 88"   230X244 CM
<b>SIZE</b>		<b>MASTER CARTON INFO</b>	
PCS.		QUANTITY PER M. CARTON: 1 M. CARTON WEIGHT (KG): 28,64 M. CARTON WEIGHT (LBS): 63,008 M. CARTON SIZE (M): 0,63 X 0,34 X 0,48 M. CARTON SIZE (INCH): 24,8 X 13,39 X 18,9	



**HEAVY DUTY SIGMA TOWABLE 6P**

ITEM NUMBER	EAN CODE	HS CODE	FEATURES
442319002	PCS. 8718181013864	95062900	MAX 6 PERSONS TOWABLE SINGLE 840 DENIER NYLON COVER FOR BACKREST DOUBLE 840 NYLON COVER FOR BACKREST 34 GAUGE PVC - K80 ONE WAY BOSTON VALVE 4 WEBBING TOW POINT 45 REINFORCED HANDLES WITH NEOPRENE KNUCKLE GUARDS 2 NEOPRENE HANDLES STRONG AND FAST TARPULIN BOTTOM NEOPRENE SEAT PAD THREE-DOUBLE-STITCHED DEFLATED SIZE : 122" X 122"   310X 310 CM
<b>SIZE</b>			<b>MASTER CARTON INFO</b>
PCS.		QUANTITY PER M. CARTON: 1 M. CARTON WEIGHT (KG): 53,25 M. CARTON WEIGHT (LBS): 117,15 M. CARTON SIZE (M): 0,55 X 0,32 X 0,73 M. CARTON SIZE (INCH): 21,65 X 12,6 X 28,74	



### HEAVY DUTY SONAR TOWABLE 4P

ITEM NUMBER	EAN CODE	HS CODE	FEATURES
442319001	PCS. 8718181013857	95062900	MAX 4 PERSONS TOWABLE SINGLE 840 DENIER NYLON COVER FOR BACKREST DOUBLE 840 NYLON COVER FOR BACKREST 34 GAUGE PVC - K80 ONE WAY BOSTON VALVE 4 WEBBING TOW POINT 8 REINFORCED HANDLES WITH NEOPRENE KNUCKLE GUARDS 6 NEOPRENE HANDLES STRONG AND FAST TARPULIN BOTTOM MULTI-POSITION TOWABLE: SWITCH POSITIONS NEOPRENE SEAT PAD THREE-DOUBLE-STITCHED DEFLATED SIZE : 126" X 76.7"   320X195 CM
SIZE	MASTER CARTON INFO		
PCS.		QUANTITY PER M. CARTON: 1 M. CARTON WEIGHT (KG): 0,01 M. CARTON WEIGHT (LBS): 0,022 M. CARTON SIZE (M): 0,68 X 0,38 X 0,49 M. CARTON SIZE (INCH): 26,77 X 14,96 X 19,29	



**HEAVY DUTY SONAR TOWABLE 6P**

ITEM NUMBER	EAN CODE	HS CODE	FEATURES
442319003	PCS. 8718181013871	95062900	MAX 6 PERSONS TOWABLE SINGLE 840 DENIER NYLON COVER FOR BACKREST DOUBLE 840 NYLON COVER FOR BACKREST 34 GAUGE PVC - K80 ONE WAY BOSTON VALVE 4 WEBBING TOW POINT 12 REINFORCED HANDLES WITH NEOPRENE KNUCKLE GUARDS 2 NEOPRENE HANDLES STRONG AND FAST TARPULIN BOTTOM MULTI-POSITION TOWABLE: SWITCH POSITIONS NEOPRENE SEAT PAD THREE-DOUBLE-STITCHED DEFLATED SIZE : 155"X 96"   395X 244 CM
<b>SIZE</b>			<b>MASTER CARTON INFO</b>
PCS.		QUANTITY PER M. CARTON: 1 M. CARTON WEIGHT (KG): 53,25 M. CARTON WEIGHT (LBS): 117,15 M. CARTON SIZE (M): 0,55 X 0,32 X 0,73 M. CARTON SIZE (INCH): 21,65 X 12,6 X 28,74	



### HEAVY DUTY MULTI RIDER 6P

ITEM NUMBER	EAN CODE	HS CODE	FEATURES
443217061	PCS. 8718181222976	95062900	THICKNESS PVC: 0.9 MM MAX 6 PERSONS TOWABLE DOUBLE TOW POINT HALKEY ROBERTS VALVE EXTRA-LONG NOSE AND REINFORCED SIDE FLOATS FOR MORE STABILITY
<b>SIZE</b>		<b>MASTER CARTON INFO</b>	AIRTIGHT AND EXTRA DURABLE THERMO BONDED SEAMS PROTECTING RUB STRAKE UNDER FLOATS AND MAIN CHAMBER DESIGNED FOR MINIMAL RESISTANCE REPAIR KIT AND PUMP INCLUDED DEFLATED SIZE : 215" X 51", 548 X 130 CM
PCS.		QUANTITY PER M. CARTON: 1 M. CARTON WEIGHT (KG): 28,93 M. CARTON WEIGHT (LBS): 63,646 M. CARTON SIZE (M): 0,9 X 0,51 X 0,33 M. CARTON SIZE (INCH): 35,43 X 20,08 X 12,8	

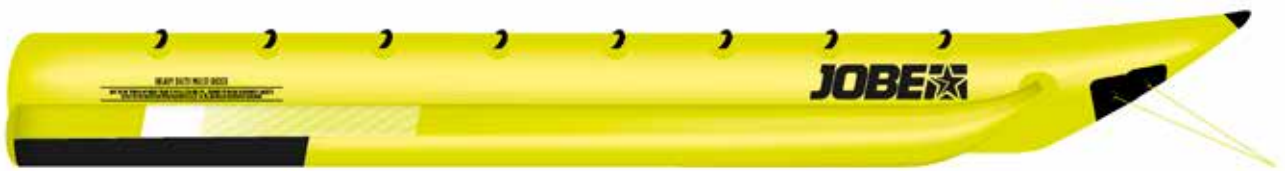

**HEAVY DUTY MULTI RIDER 8P**

ITEM NUMBER	EAN CODE	HS CODE	FEATURES
443217081	PCS. 8718181222983	95062900	THICKNESS PVC: 0.9 MM MAX 8 PERSONS TOWABLE DOUBLE TOW POINTS HALKEY ROBERTS VALVE EXTRA LONG NOSE AND REINFORCED SIDE FLOATS GARANTUEES MORE STABILITY AIRTIGHT AND EXTRA DURABLE THERMO BONDED SEAMS PROTECTING RUB STRAKE UNDER FLOATS AND MAIN CHAMBER SPECIAL SHAPE ENSURES MINIMAL RESISTANCE REPAIR KIT AND PUMP INCLUDED DEFLATED SIZE : 263" X 51", 668 X 130 CM
SIZE	MASTER CARTON INFO		
PCS.	QUANTITY PER M. CARTON: 1 M. CARTON WEIGHT (KG): 41,8 M. CARTON WEIGHT (LBS): 91,96 M. CARTON SIZE (M): 1,05 X 0,66 X 0,32 M. CARTON SIZE (INCH): 41,14 X 25,98 X 12,6		



### HEAVY DUTY MULTI RIDER 10P

ITEM NUMBER	EAN CODE	HS CODE	FEATURES
443217091	PCS. 8718181222990	95062900	THICKNESS PVC: 0.9 MM MAX 10 PERSONS TOWABLE DOUBLE TOW POINTS HALKEY ROBERTS VALVE EXTRA-LONG NOSE AND REINFORCED SIDE FLOATS FOR MORE STABILITY
<b>SIZE</b>		<b>MASTER CARTON INFO</b>	AIRTIGHT AND EXTRA DURABLE THERMO BONDED SEAMS PROTECTING RUB STRAKE UNDER FLOATS AND MAIN CHAMBER DESIGNED FOR MINIMAL RESISTANCE REPAIR KIT AND PUMP INCLUDED DEFLATED SIZE : 310" X 51", 788 X 130 CM
PCS.		QUANTITY PER M. CARTON: 1 M. CARTON WEIGHT (KG): 66,88 M. CARTON WEIGHT (LBS): 147,136 M. CARTON SIZE (M): 1,44 X 0,71 X 0,42 M. CARTON SIZE (INCH): 56,69 X 27,95 X 16,54	



**HEAVY DUTY MULTI RIDER 10P DOUBLE**

ITEM NUMBER	EAN CODE	HS CODE	FEATURES
443217092	PCS. 8718181223003	95062900	THICKNESS PVC: 0.9 MM MAX 10 PERSONS TOWABLE DOUBLE TOW POINTS HALKEY ROBERTS VALVE EXTRA LONG NOSE AND REINFORCED SIDE FLOATS GARANTUEES MORE STABILITY
<b>SIZE</b>		<b>MASTER CARTON INFO</b>	AIRTIGHT AND EXTRA DURABLE THERMO BONDED SEAMS PROTECTING RUB STRAKE UNDER FLOATS AND MAIN CHAMBER SPECIAL SHAPE ENSURES MINIMAL RESISTANCE REPAIR KIT AND PUMP INCLUDED DEFLATED SIZE : 192" X 90.5", 488 X 230 CM
PCS.		QUANTITY PER M. CARTON: 1 M. CARTON WEIGHT (KG): 54 M. CARTON WEIGHT (LBS): 119,05 M. CARTON SIZE (M): 1,44 X 0,71 X 0,42 M. CARTON SIZE (INCH): 56,69 X 27,95 X 16,54	





### HEAVY DUTY COMBO SKIS YOUTH

ITEM NUMBER	EAN CODE	HS CODE	FEATURES
442016002	59INCH 8718181237635	95062900	HIGH PRESS FIBERGLASS MOLDED EXTRA STRONG BINDING RUBBER WIDTH OF THE NOSE AND TAIL GIVES YOU MORE STABILITY 3 CM FLAT FIN GIVES YOU CONTROL THE REPLACEBLE BUMPERS ON THE NOSE AND TAIL MAKE THIS SKI MORE DURABLE
SIZE	MASTER CARTON INFO		
59INCH	QUANTITY PER M. CARTON: 1 M. CARTON WEIGHT (KG): 8,36 M. CARTON WEIGHT (LBS): 18,392 M. CARTON SIZE (M): 1,74 X 0,19 X 0,19 M. CARTON SIZE (INCH): 68,5 X 7,48 X 7,48		



**HEAVY DUTY COMBO SKIS ADULT**

ITEM NUMBER	EAN CODE	HS CODE	FEATURES
442016001	67INCH 8718181197007	95062900	HIGH PRESS FIBERGLASS MOLDED EXTRA STRONG BINDING RUBBER WIDTH OF THE NOSE AND TAIL GIVES YOU MORE STABILITY 3 CM FLAT FIN GIVES YOU CONTROL THE REPLACEBLE BUMPERS ON THE NOSE AND TAIL MAKE THIS SKI MORE DURABLE
SIZE	MASTER CARTON INFO		
67INCH	QUANTITY PER M. CARTON: 1 M. CARTON WEIGHT (KG): 10,12 M. CARTON WEIGHT (LBS): 22,264 M. CARTON SIZE (M): 1,74 X 0,19 X 0,19 M. CARTON SIZE (INCH): 68,5 X 7,48 X 7,48		



**HEAVY DUTY FRONT TOE**

▶ 443507001



**HEAVY DUTY SQUEEZE HEEL**

▶ 443507002



**HEAVY DUTY COMBO WATERSKIS END CAPS**

▶ 449918001



**HEAVY DUTY COMBO FIN WITH SCREWS SET**

▶ 443807001



**HEAVY DUTY WAKEBOARD BINDINGS**

ITEM NUMBER	EAN CODE	HS CODE	FEATURES
443917001	S 8718181229838 M 8718181229821 L 8718181229814	95062900	ADJUSTABLE SHOE SIZES COMFORTABLE ERGONOMIC FOOT BED SOFT HEEL PADS FOR PROPER FOOT PLACEMENT SOFT AND COMFORTABLE FOAM INNER LINER DURABLE EVA FOAM HEEL STRETCHY FLEX PANELS TO CONTROL YOUR RIDE USER FRIENDLY VELCRO STRAPS FOR A FAST ENTRY
<b>SIZE</b>		<b>MASTER CARTON INFO</b>	
S   M   L		QUANTITY PER M. CARTON: 6 M. CARTON WEIGHT (KG): 20,5 M. CARTON WEIGHT (LBS): 45,19 M. CARTON SIZE (M): 0,56 X 0,4 X 0,7 M. CARTON SIZE (INCH): 21,85 X 15,75 X 27,56	





**HEAVY DUTY WAKEBOARD**

ITEM NUMBER	EAN CODE	HS CODE	FEATURES
442717001	132 8718181229708 137 8718181229715 142 8718181229722	95062900	A BOARD MADE FOR RENTAL COMPANIES ABS THAT PRIMARILY FUNCTIONS TO PROTECT THE CORE AND EDGE FROM DAMAGE PROTECTIVE SINTERED BASE FULL WOOD CONSTRUCTION IS DURABLE AND OFFERS CONTROLLED FLEX SMOOTH AND CONTINUOUS ROCKER ARCH PROVIDES SPEED
<b>SIZE</b>		<b>MASTER CARTON INFO</b>	
132   137   142		QUANTITY PER M. CARTON: 1 M. CARTON WEIGHT (KG): 6,6 M. CARTON WEIGHT (LBS): 14,52 M. CARTON SIZE (M): 1,44 X 0,46 X 0,08 M. CARTON SIZE (INCH): 56,61 X 18,11 X 2,99	



**HD WAKEBOARD TIP|TAIL PROTECTORS**

ITEM NUMBER	EAN CODE	HS CODE	FEATURES
449914016	PCS. 8718181147828	95062900	
<b>SIZE</b>	<b>MASTER CARTON INFO</b>		
PCS.	QUANTITY PER M. CARTON: 40 M. CARTON WEIGHT (KG): 11 M. CARTON WEIGHT (LBS): 24,2 M. CARTON SIZE (M): 0,35 X 0,15 X 0,03 M. CARTON SIZE (INCH): 13,78 X 5,91 X 1,18		



**HEAVY DUTY HARDSHELL HELMET YELLOW**

ITEM NUMBER	EAN CODE	HS CODE	FEATURES
443719001	XS 8718181007757 S 8718181007733 M 8718181007726	65061010	ADJUSTABLE CHIN STRAP PROTECTIVE EAR PADS LIGHT WEIGHT HELMET DUAL DENSITY RING LINER. SOFT AND COMFORTABLE FIT
<b>SIZE</b>	L 8718181007719 XL 8718181007740	<b>MASTER CARTON INFO</b>	
XS   S   M   L   XL		QUANTITY PER M. CARTON: 5 M. CARTON WEIGHT (KG): 4,4 M. CARTON WEIGHT (LBS): 9,7 M. CARTON SIZE (M): 0,92 X 0,29 X 0,24 M. CARTON SIZE (INCH): 36,02 X 11,22 X 9,25	





**HEAVY DUTY SOFTSHELL HELMET RED**

ITEM NUMBER	EAN CODE	HS CODE	FEATURES
443714002	S 8718181142496 M 8718181015608 L 8718181142472	95062900	SOFT COMFORTABLE EVA PADDING VELCRO CHIN STRAP
<b>SIZE</b>		<b>MASTER CARTON INFO</b>	
S   M   L		QUANTITY PER M. CARTON: 6 M. CARTON WEIGHT (KG): 4,62 M. CARTON WEIGHT (LBS): 10,164 M. CARTON SIZE (M): 0,48 X 0,24 X 0,15 M. CARTON SIZE (INCH): 19 X 9,5 X 6	



**HEAVY DUTY SOFTSHELL HELMET YELLOW**

ITEM NUMBER	EAN CODE	HS CODE	FEATURES
443714003	S 8718181142526 M 8718181142519 L 8718181142502	95062900	SOFT COMFORTABLE EVA PADDING VELCRO CHIN STRAP
<b>SIZE</b>		<b>MASTER CARTON INFO</b>	
S   M   L		QUANTITY PER M. CARTON: 6 M. CARTON WEIGHT (KG): 4,62 M. CARTON WEIGHT (LBS): 10,164 M. CARTON SIZE (M): 0,48 X 0,24 X 0,15 M. CARTON SIZE (INCH): 19 X 9,5 X 6	



**INSTORE PROMOTION**

**INSTORE PROMOTION**



**INFLATABLE CHAIR**

▶ 360014001

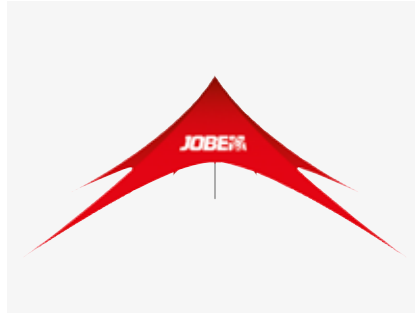

**PROMO EVENT TENT RED**

▶ 360014005



**PROMO EVENT TENT LIME**

▶ 360017019



**JOBE FLOATABLE CORK KEYCHAIN**

▶ 360019026



**JOBE USB LOGO**

▶ 360017005



**PEN**

▶ 360018019



**UNIVERSAL BOARD DISPLAY**

▶ 360017026



**BEACH FLAG**

▶ 360017003



**AERO SUP DISPLAY**

▶ 360017020



**WAKEBOARD TEST DISPLAY BOATING**

▶ 360017027



**SUP BOUTIQUE**

▶ 360017022



**SUP RACK**

▶ 360017023



**SUP RACK EXTENSION**

▶ 360017024

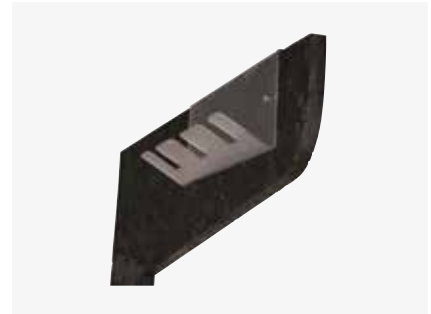

**SUP PADDLEHOLDER**

▶ 360017036



**STANDALONE PADDLE HOLDER**

▶ 360018007

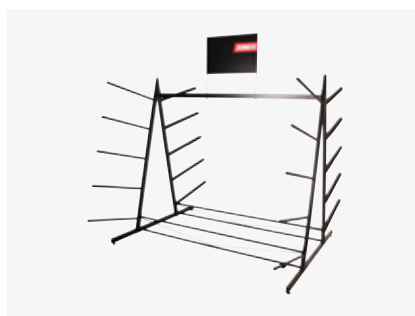

**SUP BEACH DISPLAY**

▶ 360017034



**WHEELS FOR SUP BEACH DISPLAY**

▶ 360017043



**JOBE LOGO FLAG**

▶ 360017002



**JOBE DOORMAT RED**

▶ 360016005



**SHOP/EVENT BANNER SUP**

▶ 360018015

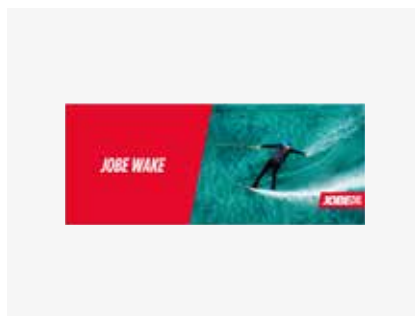

**SHOP/EVENT BANNER WAKE**

▶ 360018016



**SHOP/EVENT BANNER BOATING**

▶ 360018017

**INSTORE PROMOTION**



**FULL COLOR GRIDWALL WETSUIT VISUALS**

▶ VISUAL 2: 360018037 | VISUAL 3: 360018038 | VISUAL 4: 360018039 | WETSUIT: 360018031

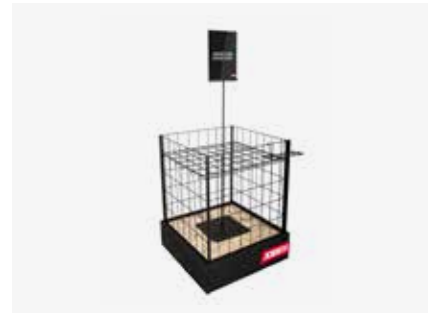

**ENTRANCE IMPULSE BIN**

▶ 360018005

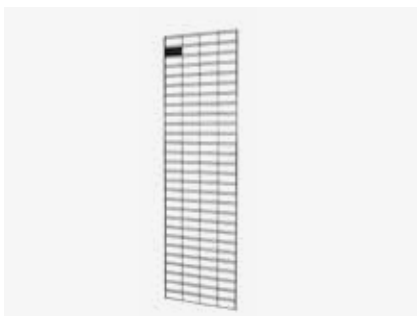

**SHELF SYSTEM 1.0 - BUDGET**

▶ 360018003



**SHELF SYSTEM 1.0 VISUAL UPGRADE KIT**

▶ 360018002

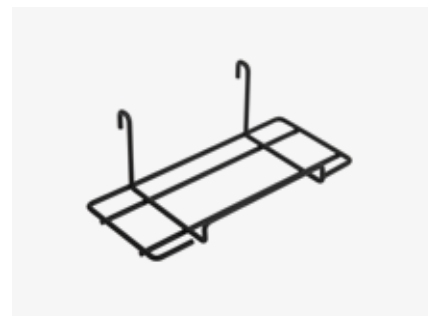

**SHOESHELF IMPULSE BIN/GRIDWALL**

▶ 360018030

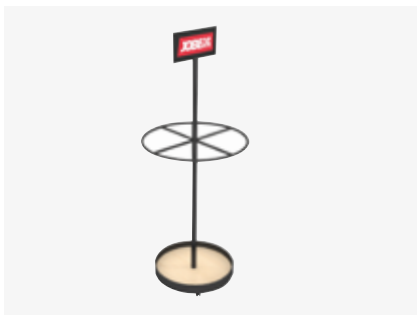

**SKI AND BOARD ISLAND**

▶ 360018021

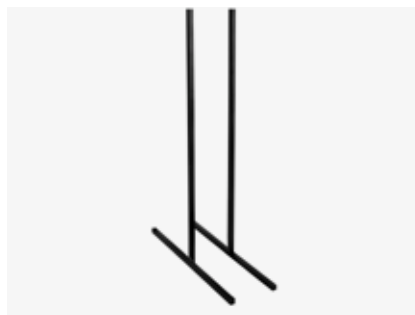

**HEAVY DUTY GRID LEGS**

▶ 360018033



**CARD HOLDER FOR GRIDWALL**

▶ 360018034



**TELESCOPIC CARD HOLDER**

▶ 360018029



**SHOE/BINDING DISPLAY**

▶ 360018006



**WARRANTY SIGN**

▶ 360018008



**BRANDCODE SHELF SYSTEM FRAME**

► 360019003

**ARTWORK FRAME BRANDCODE SHELF SYSTEM**

► 360019009



**BOARDSHORT DISPLAY**

► 360017030



**COMMUNICATION FRAME DISPLAY**

► 360017025



**JOBES SHOP SIGNAGE BIG**

► 360018010

**INSTORE PROMOTION**



**WINDOW STICKERS 1M**

▶ WHITE: 360017006 - BLACK: 360017007



**JOBE DIECUT STICKER BIG**

▶ BLACK: 360017009 - RED: 360017010 - WHITE: 360014008



**JOBE DIECUT STICKER SMALL**

▶ BLACK: 360017012 - RED: 360017013 - WHITE: 360017011



**BOARDSHORT HANGER**

▶ 360015009



**CLOTHES HANGER**

▶ 360015008



**HEAVY DUTY WETSUIT HANGER**

▶ 360018024



**COUNTER DISPLAY**

▶ 360017031



**JOBE SUNGLASSES DISPLAY**

▶ 360018042



**JOBE BOATING GUIDE DISPLAY**

▶ 360018001



**INDOOR POOL EVENTS**

▶ 360019001



**OUTDOOR POOL EVENTS**

▶ 360019002





**PAPER BAG SMALL**

▶ 360816001



**PAPER BAG LARGE**

▶ 360816002



**MANNEQUIN MALE**

▶ 450017001



**MANNEQUIN FEMALE**

▶ 450017002



**MANNEQUIN KIDS**

▶ 450017003



**HELMET HOLDER BLACK**

▶ 450015001

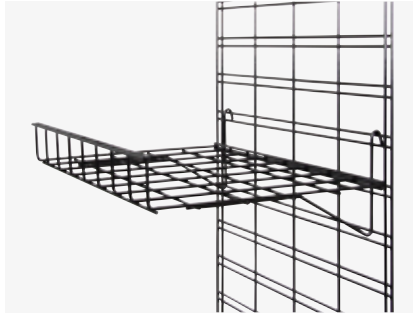

**FLAT SHELF 15" X 24" BLACK**

▶ 450015002



**SINGLE PRONG HOOK 4" BLACK**

▶ 450015003



**SINGLE PRONG HOOK 10" BLACK**

▶ 450015004



**7 BALL WATERFALL ARM BLACK**

▶ 450015005

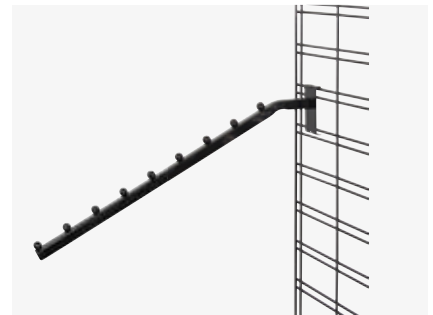

**9 BALL WATERFALL ARM BLACK**

▶ 360018032

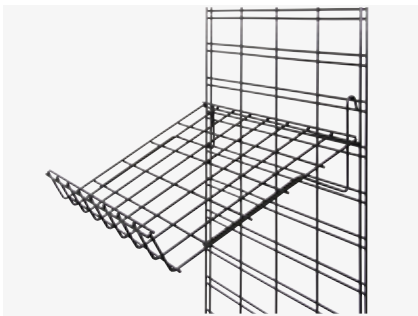

**SLOPING SHELF 15" X 24" BLACK**

▶ 450015006



**JOINING CLIPS BLACK**

▶ 450015008



**WALL FIXING 6.5CM BLACK**

▶ 450015007

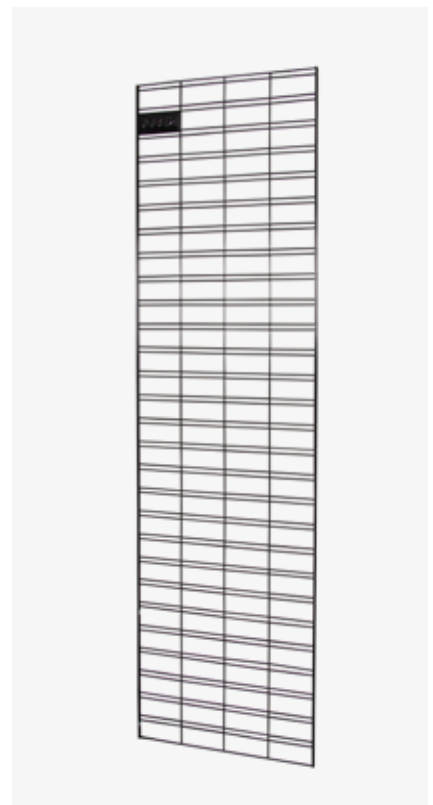

**SLATWALL GRID 2FT X 7FT BLACK**

▶ 450015009



**HANGRAIL U-SHAPE**

▶ 450015012

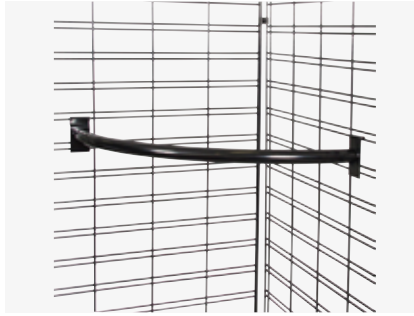

**HANGRAIL ROUND**

▶ 450015013

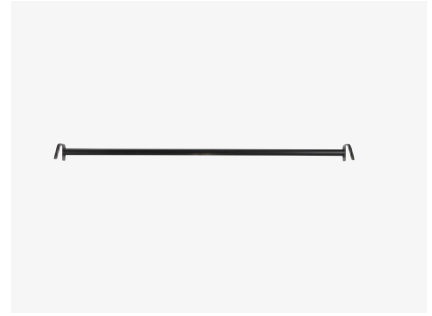

**HANGRAIL STRAIGHT**

▶ 450015011